





BERT WILLIAMS

### Williams On Advisory Board

Bert Williams, a grain producer from Farwell, was named to a Pioneer Hi-Bred International, Inc. grain transportation advisory panel. Williams and other panel members will translate results of the "Pioneer Poll on Grain Transportation" into specific recommendations, Pioneer President Thomas N. Urban said in making the announcement. "Williams was chosen to represent the farmers' view of the grain transportation situation for the southern plains states," Urban said. Williams and two of his sons farm 6,000 acres of corn, cotton and wheat. He started farming with his father 34 years ago.



## To The Editor

Dear Mr. Ellis,  
I have never written to a newspaper before in my life. But, I am writing now.  
I have a question to ask which I doubt anyone has the answer to. Why are groceries getting so high?  
They are going up over night. Literally, I went to our local market last Thursday night. A gallon of their milk was \$2.19. I went back the very next day to buy my week's groceries and the same brand of milk was \$2.25. I could name a lot of products that have increased in price just as rapidly.

I don't suppose you will put this in the paper. But I just had to write and let you know what is happening to this wonderful United States of ours.  
I know we are the land of plenty. But what happens when you can't afford it anymore?

There are a lot of things people can do without. But not food. Every living thing must have nourishment.

Sincerely,  
Mrs. J. Huddleston



## Book Talk

By NELSON LEWIS

"James Herriot's Yorkshire" is available at Friona Public Library.  
Don't miss this one even if you only look at the 240 color photos. For those who claim English ancestors it's like a trip back home. Herriot is a transplanted Scot just as I am a transplanted Virginian; perhaps that similarity helps me appreciate his fondness for Yorkshire. I must confess to a twinge of envy—he describes his adopted land better than I can.

In case you don't know Herriot he is the country veterinarian who has written such delightful books as "All Things Bright and Beautiful," "All Things Wise and Wonderful" and "All Creatures Great and Small." I suggest you read Yorkshire first, it will enhance your enjoyment of the others.

"How To Do Everything" by Heza Whizz is also available.

The above title contains not one grain of truth, just wry humor. But our library has a number of really good "how to" books. With inflation gnawing away at incomes it might be a good idea to select a couple and become a "do-it-yourselfer" for spring and summer projects. They must be universally helpful because millions have been sold. They have only one competitor in the publishing world—cookbooks.

I guess both come under the heading of pre-packaged self-reliance.



SPEECH WINNERS....Friona High School entrants did well at the Canyon speech tournament last weekend. Debators Mark Zachary and Mark Blankenship (holding trophy, center) placed first, Sharla Duggins, second from left, seated, placed first in prose, Christy Bengel, second from right, was third in poetry.

Other students shown made the semi-finals of the meet, including (back row) Stanley Ellis in informative speaking and Shae Dodson in persuasive speaking and (front row) Kipi Fleming in prose reading and Patti Hinton in poetry reading. Stacy Laymance also made the semi-finals and was not available for the picture.



JOE MALOUF, long jump specialist for the Chieftain track team, is shown taking off on one of his jumps at Bovina, where he won first place with a leap of 20 feet, six inches.

## In Honor Of "Doctor's Day"

PHYSICIAN'S PRAYER  
Lord, Who on earth didst minister  
To those who helpless lay  
In pain and weakness, hear me now,  
As unto Thee I pray.

Give to mine eyes the power to see  
The hidden source of ill,  
Give to my hand the healing touch  
The throb of pain to still.

Grant that mine ears be swift to hear  
The cry of those in pain;  
Give to my tongue the words that bring  
Comfort and strength again.

Fill Thou my heart with tenderness,  
My brain with wisdom true,  
And when in weariness I sink,  
Strengthen Thou me anew.

So in Thy footsteps may I tread,  
Strong in Thy strength always,  
So may I do Thy blessed work  
And praise Thee day by day.

Lois Norwood...  
**AN INSURANCE LESSON: IF IT...**  
WON'T BURN  
CAN'T BLOW DOWN  
BE STOLEN  
CAUSE A LAWSUIT  
GET LOST  
HURT ANYONE  
**THEN DON'T INSURE IT!**  
Ethridge-Spring Agency Inc.  
YOUR INSURANCE AGENT

Church Chuckles by CARTWRIGHT  
  
REV. TWEDDLE, D.D.  
1330  
"If the Millenium came tomorrow you'd be at the unemployment office the day after!"

Welcome To Friona  
Houser Grocery  
Reeve Chevy-Olds  
Keep That Great GM Feeling With Genuine GM Parts  
Rockwell Bros. Of Friona  
Friona State Bank  
Horn-Clayton Ins.  
Friona Ford Sales  
Ethridge-Spring  
These Sponsors Welcome You To Friona's Churches

FIRST BAPTIST Sixth & Summitt--Rev. C.H. Murphy	UNITED PENTECOSTAL CHURCH 5th & Ashland--
CALVARY BAPTIST 14th & Cleveland--Murle Rogers, Pastor	6th ST. IGLESIA de CRISTO 408 W. Sixth
TEMPLO BAUTISTA 4th & Woodland--Rev. Donnie Carrasco	6th ST. CHURCH OF CHRIST 502 W. Sixth--H.D. Simmons, Jr.
ST. ESTHER'S BAPTIST CHURCH 5th & Main--Rev. I.S. Ansley, Pastor	10th ST. CHURCH OF CHRIST 10th & Euclid--
FRIONA UNITED METHODIST CHURCH 8th & Pierce--Rev. Jim Boswell	FIRST ASSEMBLY OF GOD 10th & Ashland--Jim Bond
REDEEMER LUTHERAN CHURCH 13th and Virginia--2:30 p.m. Edward Brown (Vacancy Pastor) Hereford	TEMPLO "MARANATHA" SPANISH ASSEMBLY OF GOD 301 Grand--Rafael Rodriguez
UNION CONGREGATIONAL CHURCH Euclid At 16th--Rev. Skip Sircic	ST. TERESA'S CATHOLIC CHURCH 16th & Cleveland-- Ronald McGovern, S.A. Administrator
IMMANUEL LUTHERAN CHURCH Rhea Community--8:15 a.m. Herman J. Schelter (Vacancy Pastor) Lariat	

Attend Church Regularly!

# REMEMBER WHEN?



Seventy years ago, this was the city of Friona, and its population most probably could have been taken by one worker in a half-day's work. Among the buildings is the old Congregational Church in the center left. The old

Friona State Bank building is at far right. The town has changed, and we have changed in the last 70 years, and we have modernized in our efforts to save the growing community.



FRIONA STATE BANK

# Letter To The Editor

Dear Editor:  
Please read the following list and see if you know what it is from.

1. Abolition of property in land and application of all rents of land to public purposes.
2. A heavy progressive or graduated income tax.
3. Abolition of all rights of inheritance.
4. Confiscation of the property of all emigrants and rebels.
5. Centralization of credit in the hands of the State, by means of a national bank with state capital and an exclusive monopoly.
6. Centralization of the means of communication and transport in the hands of the State.
7. Extension of factories and instruments of production owned by the State, the bringing into cultivation of waste lands, and the improvement of the soil generally in accordance with a common plan.
8. Equal liability of all to labor. Establishment of industrial armies, especially for agriculture.
9. Combination of agriculture with manufacturing industries, gradual abolition of the distinction between town and country by a more equable distribution of population over the country.
10. Free education for all children in public schools. Abolition of childrens factory labor in its present form. Combination of education with industrial production.

If you did not recognize them, they are goals of the Communist Manifesto.

Would you like to compare this system to our own? Consider these comparisons with the above goals:

1. Carter has already signed an article destroying our right to own property. Congress has to ratify it before it becomes law. This same congress ratified giving away the Panama Canal.
2. A heavy progressive and graduated income tax.
3. Inheritance tax, a tax on our God given right to die.
4. Confiscation by certain agencies such as the IRS of property belonging to anyone that dares to stand up for his rights and to disagree with the system.
5. World Bank, Farmers Home Administration, Chase Manhattan Bank, Small Business Administration.
6. All major networks, newspapers, magazines, air lines, etc. are owned or the major stock is controlled by members of the Trilateral Commission. Also all major oil companies, which are limiting our travel by automobile.
8. Equal opportunity employment.
9. Destruction of the family farm, ownership then belonging to the government loan facilities.
10. Free lunches, government funding for schools who will comply with their teaching methods and material.

/s/ Arlen May

## Happy Birthday To Friona Folks

### WEEK OF MARCH 29-APRIL 4

Friona residents having birthdays next week are:

- Kitty Loveless, March 29
- Lisa Brockman, March 29
- Loy McLellan, March 29
- Bobbie Jo Saiz, March 29
- Karen Ball, March 29
- Jana Brown, March 30
- Leonard Coffey, March 30
- T.J. Reed, March 30
- Juanita Reed, March 30
- Vernon Roberts, March 30
- Cynthia Vega, March 30
- Wayne Jones, March 31
- Trisha Gibson, March 31
- Kathy Boeckman, March 31
- Floyd Brookfield, March 31
- Kelly Wied, March 31
- Levy Lee Woodruff, April 1
- Ronnie Reed, April 1
- Hanna Carmichael, April 1
- Sue Proctor, April 1
- Gerald Reed, April 1
- Larry Chandler, April 1
- Erika Bermea, April 2
- Grace Whitefield, April 2
- Monte Rule, April 2
- Daniel Gowens, April 2
- Rusty Ridley, April 3
- Charla Beth Chesher, April 3
- H.A. Hyde, April 3
- Denise Hall, April 3
- Homer A. Hyde, April 3
- Glenn Hill Rebber, April 4
- Herschel Johnson, April 4
- Floyd Wilkins, April 4

If you or someone in your family has a birthday coming up soon, call the Friona Star at 247-2211 by Thursday noon and report it.

# Savings Roll Into Your Basket At Venture!



**Contac**  
\$1.39  
10 CT. PKG.



**Bounce**  
\$1.79  
40 CT. BOX

WILSON'S CERTIFIED BONELESS FULLY COOKED WATER ADDED 3-5 LB. AVG.

## Half Hams

\$1.79

WRIGHT'S HICKORY SMOKED SLAB Sliced Bacon 99¢



### Meat Specials

OSCAR MAYER'S BREAKFAST STRIPS 12 OZ. PKG. \$1.39  
**Lean-N-Tasty**  
SHENANDOAH WHITE/DARK Turkey Roast 2 LB. PKG. \$3.69

SHURFRESH 4-6 LB. AVG. Baking Hens LB. 69¢  
BANQUET GRAVY & SLICED Turkey 2 LB. PKG. \$2.39  
GOOCH GERMAN BRAND SMOKED Sausage 12 OZ. PKG. \$1.49

D.A.K. SLICED Cooked Ham 4 OZ. PKG. 99¢  
GLOVER MEXICAN STYLE Hot Links LB. 89¢  
KRAFTS WISCONSIN LONGHORN Cheese LB. \$1.99

### HAVE A HAPPY EASTER!

#### Dairy And Frozen Food

KRAFT PHILADELPHIA PLAIN Cream Cheese 8 OZ. PKG. 73¢  
SHURFRESH 1/4 PT. CTN. Whipping Cream 39¢  
BIRDSEYE Cool-Whip 8 OZ. BOWL 59¢  
SHURFINE SLICED Strawberries 10 OZ. CTN. 59¢

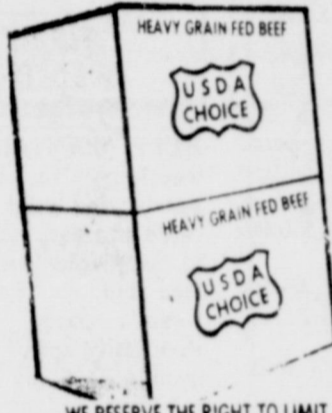

Boxed Beef is only the useable portions of the carcass skillfully trimmed and packaged through ultra-modern processing, then vacuum sealed and boxed for ease of handling. Cutting these portions to desired roasts and steaks does not require a trained butcher. In fact, many housewives across the country prepare the boneless cuts to their own requirements right in their kitchens. What a fine way to get just exactly the cuts you need and save dollars on quality beef at the same time. However, on any Boxed Beef purchase you make with us we gladly cut and wrap it to your own specifications.

### ADVANTAGES:

1. Boxed Beef is naturally aged, thanks to its patented vacuum wrapping.
2. More sanitary-less bacteria.
3. You buy meat without the surplus waste fat and bone.
4. You save money in buying meat instead of bone, fat, and trimmings.
5. Quality controlled beef. Only the best beef is selected to go in the Boxed Beef program.
6. You can buy only the part of the beef that you want.

Valuable Coupon Worth \$1.00  
TOWARD THE PURCHASE OF THIS WEEK'S FEATURED ITEM  
DINNER NAPKINS  
Our Reg. Discount Price \$4.99  
Coupon Savings 1.00  
Your Price (with coupon) \$3.99  
COUPON GOOD MARCH 30  
THRU APRIL 5, 1980

UNDERWOOD Deviled Ham 3 2 1/2 OZ. CANS \$1  
BAKERS ANGEL FLAKE Coconut 7 OZ. BAG 79¢  
30% OFF LABEL Pine-Sol 28 OZ. BTL \$1.49  
30% OFF LABEL King Oxydol 84 OZ. BOX \$2.59

ASSORTED FLAVORS  
**Jell-o Gelatin** 3 OZ. 363¢

**Spic and Span** 16 OZ. 49¢

ALL GRINDS  
**Folger's Coffee** LB. CAN \$2.89

STAIN REMOVER  
**Spray 'n Wash** 32 OZ. \$1.73

BATHROOM TISSUE  
**Nice N Soft** 15¢ OFF 4 ROLL PKG. 89¢

### Fresh Produce



**Grapefruit** 25¢ Lb.  
**Carrots** 19¢ Lb.  
**Sweet Yams** 25¢ Lb.

DUNCAN HINES LAYER DELUXE II ASSORTED  
**Cake Mixes** 18 1/2 OZ. PKG. 79¢

PURE VEGETABLE  
**Crisco Oil** 48 OZ. BTL \$2.19

**Venture FOODS**  
**Houser Venture Grocery**  
902 Main Street Friona, Texas Ph. 247-3343





# Lazbuddie News

By JANET WILKE

## VOLLEYBALL TOURNEY SOON

The Lazbuddie Band Boosters are sponsoring an Outsider's Volleyball Tournament the week of April 14-20. There will be trophies given to the winning teams. All of the proceeds will benefit the Longhorn Band.

Entry forms may be secured from Jerry Engelking, and the forms must be submitted back to Engelking no later than April 7.

There will be a limited number of teams that will be taken, so it is advantageous to sign up as soon as possible in order to assure a spot for your team.

Entries must be sent with the name of the team, team roster, name of the team captain on the entry. Please be sure to include a \$20.00 entry fee.

Mail entries to Jerry Engelking, Rt. 3, Box 78, Muleshoe, Texas 79347.

Don't miss out on the fun in the Longhorn Volleyball Tournament.

## SPRING BREAK OBSERVED

Students and teachers alike will be able to spend a few days at home this next week, as Easter vacation for Lazbuddie ISD begins.

Many of the students and teachers will be gone for the holidays, and it is

our hope, that if they travel, they will drive with care.

While Easter Break will be over on Monday, April 7, and the classes will resume as regular, there will be a school board trustee election during the vacation period.

If any of you are planning to be gone during the vacation, it is important that you vote before you go.

Absentee voting may be accomplished in the Tax Assessor/Collector's office of the school during the hours of 8:30 a.m. and 4:00 p.m. any school day. Dennis Owen is serving as absentee election clerk, and urges everyone to get out and vote absentee if you are planning to be out of town for the actual election. Don't miss out on your chance to vote.

## UIL MEET IN SUNDOWN

Several junior high and elementary students from Lazbuddie participated in the UIL Literary meet in Sundown on Friday, March 28, with some of the events starting a day ahead of time, on March 27.

Lazbuddie had a good showing in the literary competition, and the

students may be strong enough to once again bring home a trophy for the most points scored in the spring meet again this year. Should they do it, this would be the second consecutive year for Lazbuddie to win. Good luck, all of you.

## A THOUGHT FOR THE MONTH OF APRIL

"The Lord often gets his best soldiers from the Highlands of affliction."--C.H. Sturgeon.

## School Lunch

### Menu

WEEK OF MARCH 31-APRIL 2

**MONDAY**--Bar-B-Q, turkey rolls, corn, green beans, hot rolls, cake and milk.

**TUESDAY**--Soup, chili, sandwiches, mixed vegetables, crackers, light bread, applesauce and milk.

**WEDNESDAY**--Frito pie and cheese, pinto beans, greens, cornbread, cookies and milk.

# Gina Radtke, Keith Rutherford Exchange Vows In Hereford

Miss Gina Radtke and Keith Rutherford were united in marriage on "leap year day," Friday, February 29, at 8 p.m. in the parlor of the First United Methodist Church of Hereford.

Rev. Herschel L. Thurston, performed the double ring ceremony. Miss Radtke was given in marriage by her father, Mr. and Mrs. Ike Haverland, Jr. of Amarillo were the couple's attendants.

Parents of the couple are Mr. and Mrs. Gerald D. Radtke of Amarillo and Mr. and Mrs. Ted Rutherford of Tucumcari, New Mexico, formerly of Amarillo.

The bride is a graduate of Amarillo High School and is employed by the First National Bank of Amarillo. The groom is a graduate of Tascosa High School and West Texas State University. He is employed by Diamond Shamrock Corp. in Amarillo.

The groom is the grandson of the late Mr. and Mrs. Roy Slagle of Friona.

Attending the wedding were the parents of the bride, parents of the groom, and the bride's brother, Gil Radtke of Lubbock.

The couple will make their home at 3007 W. 27th, Apt. No. 7, Amarillo.



Mr. and Mrs. Keith Rutherford

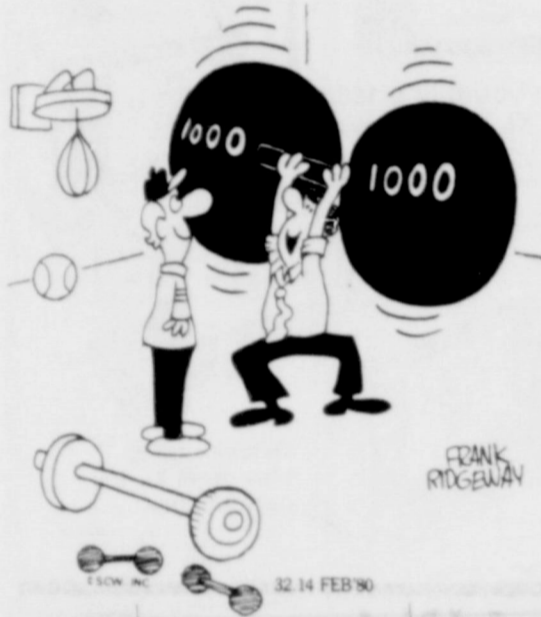

"THIS STYROFOAM MODEL WILL IMPRESS ANYBODY!"

**DICKEY-john**  
The only monitors with radar  
Now joins the Cal Jordan family of farming products . . . .

**Cal Jordan Implements**  
East Mabry Drive Clovis  
505-763-5517

# SOMETHIN'S

<b>SWIFTS CHILI</b> NO BEANS 15 OZ. CAN	<b>75¢</b>
<b>CONTADINA ROUND TOMATOES</b> 14 1/2 OZ. CAN	<b>44¢</b>
<b>THRIFT KING BLACKEYES</b> 15 OZ. CAN	<b>3/88¢</b>
<b>SWIFTS CHICKEN VIENNAS</b> 5 OZ. CAN	<b>39¢</b>

<b>TREET LUNCHEON MEAT</b> 12 OZ. CAN	<b>\$1.19</b>
<b>PEPSI</b> 6-32 OZ. BOTTLES	<b>\$1.59</b>
<b>SHURFINE EGGS</b> GRADE A MEDIUM DOZEN	<b>59¢</b>

**FRESH PIGGLY WIGGLY PRODUCE**

<b>FRESH STRAWBERRIES</b> CRT.	<b>79¢</b>
<b>CALIF. VINE RIPENED TOMATOES</b> LB.	<b>49¢</b>
<b>CALIF. GREEN SKIN AVOCADOS</b> EA.	<b>49¢</b>
<b>SUPER SELECTS CUCUMBERS</b> LB.	<b>29¢</b>

<b>BELL WHIP CREAM</b> 1/2 PT.	<b>49¢</b>
<b>BELL SOUR CREAM</b> 8 OZ. CRT.	<b>49¢</b>
<b>BELL COTTAGE CHEESE</b> 12 OZ. CRT.	<b>69¢</b>
<b>PIGGLY WIGGLY LO-FAT MILK</b> GAL.	<b>\$1.79</b>

<b>SUNSHINE LEMON COOLERS</b> 11 OZ. BOX	<b>78¢</b>
<b>TIDE FAMILY SIZE</b>	<b>\$5.38</b>
	SAVE '11"

# Lubbock Guest Gives Program

Modern Study Club met in regular session March 18 at the Women's Club House.

Faye Reeve, club president, called the meeting to order. Vera Beil led the group in prayer. Committee reports were called for by the president. Lora Mae McFarland, chairman of the library committee, reported that several new books had been ordered for the library and she encouraged each one to take advantage of the good reading material in the library. She presented each one present with a bag advertising the library to use in carrying books.

Ilene Osborn, program director, then introduced Mrs. Mary Tanner from Lubbock, a collector of old and historical books, who presented an informative discussion on pieces of glass she has collected from over the world. Mrs. Tanner introduced Mrs. Roy B. Davis who accompanied her with appropriate musical numbers on the piano.

Mrs. Tanner lectures for many occasions, brings historical

discussions at the Ranch Headquarters at the Tech Museum. She is a member of the oldest Antique Club in Lubbock, has done much travel around the world, and has collections from many of the lands she has visited.

In her discussion, Mrs. Tanner gave facts and then showed pieces of glass to commemorate the historical period; as the first bottle made in 1820; a bread plate portraying the First Continental Congress in 1876; a plate showing the signing of the Constitution; a salt cellar used for salt before the making of salt shakers; pieces showing Texas becoming independent of Mexico; the laying of the first cable across the Atlantic and the country surging ahead with the railroad. She reminded the members that the secret for our great country that we live in was that we still believe and trust in God and never give up.

The program closed with Linda Murphree leading the group in singing "America."

Refreshments were served by the hostesses, Rhea Foster and Eufaula Ethridge, to nineteen members and six visitors. The visitors were Mrs. Mary Tanner, Mrs. Roy B. Davis, Lucille Roddy, Orma Flippin, Lila Gaye Gee and Otho Whitefield.



MELINDA DIANNE MOSELEY and MITCHELL BLANE WILSON....Mr. and Mrs. Coleman Moseley and Mr. and Mrs. Richard Wilson of Friona announce the engagement and approaching marriage of their children, Melinda Dianne and Mitchell Blane. The wedding date has been set for Friday, May 30 at 7 p.m. in Friona's Calvary Baptist Church. Melinda and Mitchell are both graduates of Friona High School. The couple plans to make their home in Plainview where Melinda is employed by Dee Dee's Lady's Shop and Mitchell is a ministerial student at Wayland Baptist College.

# YH'ers Make Plans For April Programs

The Lazbuddie Young Homemakers held their regular meeting on Thursday, March 6, in the High School library.

The meeting was called to order by

## Diane Tatum Gives Program On Rose Care

The Black Study Club met Thursday, March 21 in the home of Helen Fangman.

The roll call was answered with "Quick Tips." Geneva Ivie presented the opening exercise on the many uses of vinegar.

Diane Tatum was in charge of the program and told how to take care of your roses.

The next meeting will be Thursday, April 3. The group will go to Clovis for lunch and then return to Bovina for a tour of the home of Mr. and Mrs. Kregg Wilson.

Billie Mason, president. Topics of discussion were the April Style Show and the Senior Citizen's Tea.

The Style Show will be held April 10 at 2 p.m. in the Lazbuddie School cafeteria. Volunteers for the decorating committee were Marsha Collum, Reta Mimmis, Marca Morris and Charlotte Redwine. Debbie Nickels and Debbie Weir are on the advertising committee. The refreshment committee consists of Janice Bradshaw, Cindy Cargile and Jenny Mitchell.

The Senior Citizens Tea will be held on Sunday, April 27 from 2 to 4 p.m. in the Lazbuddie School cafeteria.

The program was given by Danny May, from Decorator's Nursery and Floral in Muleshoe. The talk was very interesting and informative on landscaping and trees and shrubbery suitable for this environment.

Door prizes were won by Jo Ann McDonald and Charlotte Redwine.

Refreshments were served to Janice Bradshaw, Vickie Burch, Cindy Cargile, Marsha Collum, Sheryl Engelking, Cindy Hall, Jo Ann McDonald, Debbie Magby, Billie Mason, Reta Mimmis, Jenny Mitchell, Debbie Nickels, Charlotte Redwine, Rickie Seaton, Mandi Seaton, Nellie Vise, Debbie Weir, and advisor, Marca Morris.

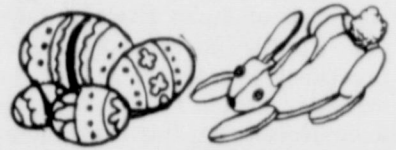

# SPECIAL EVERY TIME YOU SHOP PIGGLY WIGGLY DOUBLE S&H GREEN STAMPS ON WED. OPEN DAILY til 9:00

HORMEL SUPER SELECT PORK CHOPS	1/4 PORK LOIN FAMILY PAC LB.	\$1.19
HORMEL SUPER SELECT PORK CHOPS	CENTER CUT LOIN CHOPS LB.	\$1.89
HORMEL SUPER SELECT PORK CHOPS	CENTER CUT RIB CHOPS LB.	\$1.79
COUNTRY STYLE PORK RIBS	LB.	\$1.19

OSCAR MAYER LUNCH MEATS

COTTO SALAMI 8 OZ.	\$1.09
LUNCHEON MEAT 8 OZ.	\$1.09
CHOPPED HAM 8 OZ.	\$1.39
COOKED HAM 6 OZ.	\$1.39

MORTON'S FROZEN HONEY BUNS	9 OZ.	55¢
JENO'S FROZEN PIZZA		99¢

OSCAR MAYER WIENERS

1 LB. PKG. \$1.49

OSCAR MAYER LEAN 'n TASTY PORK STRIP	12 OZ.	\$1.19
BORDEN'S AMERICAN CHEESE	SINGLES 12 OZ.	\$1.69

BRIGHT & EARLY IMIT. ORANGE JUICE	6 OZ. CANS	4/\$1
MORTON FROZEN FRIED CHICKEN	2 LB.	\$2.39
MEADS FROZEN BREAD	2-1 LB. LOAVES	79¢
SHURFINE FROZEN CORN ON COB	4S	99¢

FINAL NET

12 OZ. REG. \$3.19

\$1.68

WICKER STRAW FAN	14 IN.	2/\$1.00
WINTUK YARN ASSORTMENT	3 OZ.	87¢



# Isidore Cordovas Have Baby Girl

Mr. and Mrs. Isidore Cordova of San Antonio are the parents of a baby girl born Sunday, March 16, at San Antonio Baptist Hospital. Named Trieste Rene Fragoza Cordova, she weighed seven pounds, fourteen and one-half ounces and was twenty inches long. Grandparents are Mr. and Mrs. Amado Coronado, Sr. of Friona and Mr. and Mrs. Tony Fragoza of Austin, Texas. Great-grandparents are Mrs. Mela Vera of Brownsville and Mr. and Mrs. Matilde Martinez of Friona. Izzy Cordova is a 1970 graduate of Friona High School.

1 IN 4 Americans Will Have Cancer In Their Lifetime. For The Best In Cancer Insurance Call

Judy Cummings  
208 East 11 Street  
Friona, Texas  
Phone 247-2150

CONGRATULATIONS T.E. You Are As Old As Daddy. We Are Both 39!

Stagner-Orsborn Buick - Pontiac - GMC 30 YEARS IN HEREFORD

See Us And SAVE

142 MILES AVE. HEREFORD, TEXAS

PHONE 364-0990

KEEP THAT GREAT GM FEELING WITH GENUINE GM PARTS

GM QUALITY SERVICE/PARTS

GENERAL MOTORS PARTS DIVISION





# PROGRAM HIGHLIGHTS ON FRIONA CABLEVISION

## MOVIES

SATURDAY 03/29/80

**8:30 AM - Ch. 9: MOVIE: 'The Bowery Boys in High Society'** The Bowery Boys are ringleaders in a plot to divert an inheritance. The Bowery Boys, Leo Gorcey, Amanda Blake. 1955.

**9:00 AM - Ch. 8: MOVIE: 'Made For Each Other'** A newly married couple face the problems of new in-laws, new babies and even new servants. Carole Lombard, James Stewart. 1939.

**11:00 AM - Ch. 8: MOVIE: 'Topaz'** This story centers around high politics, with intrigue and trickery involving French, American, Russian and Cuban security. Frederick Stafford, Dany Robin, John Forsythe. 1969.

**2:00 PM - Ch. HBO: MOVIE: 'The Getaway'** A couple involves themselves in a deadly swap-freedom for a price. Steve McQueen, Ali MacGraw, Sally Struthers. 1972.

**3:00 PM - Ch. 5: MOVIE: 'Ball of Fire'** An encyclopedist working on an analysis of American slang finds a night club singer his most fruitful source. Gary Cooper, Barbara Stanwyck. 1942.

**7:00 PM - Ch. HBO: MOVIE: 'Plague'** A scientific experiment produces a plague which spreads throughout the city. Daniel Pilon, Kate Reid.

**8:30 PM - Ch. HBO: MOVIE: 'Buckstone County Prison'** An expert tracker of escaped convicts is unjustly sentenced to a jail term. Earl Owensby. 1978.

**10:00 PM - Ch. HBO: MOVIE: 'The Getaway'** A couple involves themselves in a deadly swap-freedom for a price. Steve McQueen, Ali MacGraw, Sally Struthers. 1972.

**10:45 PM - Ch. 7: MOVIE: 'The Train'** An German officer attempts to move French art treasures into Germany hours before the armistice is declared. Burt Lancaster, Paul Scofield, Jeanne Moreau. 1965.

**11:00 PM - Ch. 2: MOVIE: 'Demetrius and the Gladiators'** Demetrius rejects and then reaffirms his faith in the barbarism of Caligula's Rome. Victor Mature, Susan Hayward, Michael Rennie, Ann Bancroft. 1954.

**11:30 PM - Ch. 9: MOVIE: 'Fall of the Roman Empire'** The son of Marcus Aurelius arranges for his father's murder and takes over as emperor, ruling with cruelty and treachery. Sophia Loren, Stephen Boyd, Alec Guinness, James Mason. 1964.

**12:00 AM - Ch. 13: MOVIE: 'Our Man In Baghdad'** A counter espionage agent for a Western power has penetrated a spy ring in a city in the Middle East and is in trouble when they realize there is an enemy in the group. Rory Calhoun, Roger Hanin. 1967.

**12:30 AM - Ch. 7: MOVIE: 'New York Confidential'** An international syndicate is operating out of New York. Broderick Crawford, Anne Bancroft, Richard Conte. 1955.

**12:30 AM - Ch. 8: MOVIE: 'White Heat'** A ruthless gangster has a mother complex, but

is known as a heartless killer. James Cagney, Virginia Mayo, Edmond O'Brien. 1949.

**1:00 AM - Ch. 5: MOVIE: 'Ball of Fire'** An encyclopedist working on an analysis of American slang finds a night club singer his most fruitful source. Gary Cooper, Barbara Stanwyck. 1942.

**3:00 AM - Ch. 8: MOVIE: 'Charlie Chan in Murder Over New York'** There is a murder on a plane trip to New York. Charlie Chan finds himself in the middle of trying to find the murderer. Sidney Toler. 1940.

**3:00 AM - Ch. 9: MOVIE: 'Geronimo'** The story of the legendary Apache leader who waged a long and personal war against the United States government. Chuck Connors, Kamala Devi, Ross Martin. 1962.

**9:30 AM - Ch. 8: MOVIE: 'Damn Yankees'** A middle-aged baseball fan makes a deal with the Devil and is transformed into a young first-class ball player. Tab Hunter, Gwen Verdon, Ray Walston. 1958.

**12:00 PM - Ch. 9: MOVIE: 'Charlie Chan at the Wax Museum'** A gangster hides out in a wax museum, waiting to kill Charlie. Sidney Toler, Marc Lawrence. 1940.

**2:30 PM - Ch. HBO: MOVIE: 'All the President's Men'** Reporters Woodward and Bernstein race for the story behind the Watergate break-in. Robert Redford, Dustin Hoffman, Jason Robards. 1976.

**3:30 PM - Ch. 9: MOVIE: 'The Mark of Zorro'** The masked marauder's nightly escapades terrify the corrupt Spanish governors of Old California. Tyrone Power, Linda Darnell, Basil Rathbone. 1940.

**5:00 PM - Ch. HBO: MOVIE: 'Revenge of the Pink Panther'** The bumbling inspector Clouseau is on the trail of the French Connection. Peter Sellers, Dyan Cannon, Herbert Lom. 1977.

**5:30 PM - Ch. 9: MOVIE: 'King of Kings'** The story of an oppressed people and how they are delivered by the Son of God in the form of Jesus, his crucifixion, and the birth of Christianity. 1962.

**7:00 PM - Ch. HBO: MOVIE: 'Oliver's Story'** Oliver picks up the pieces after his wife's death in this sequel to 'Love Story'. Ryan O'Neal, Candice Bergen. 1978.

**8:00 PM - Ch. 2: MOVIE: 'A Psychotic Killer of Women Terrifies a City, and an Ambitious Columnist Capitalizes on the Panic.'** David Janssen, Robert Vaughn. 1980 (CLOSED-CAPTIONED).

**10:00 PM - Ch. HBO: MOVIE: 'All the President's Men'**

**10:30 PM - Ch. 9: MOVIE: 'Call of the Wild'** A young man, his pal and a girl are stranded in the Yukon. Clark Gable, Loretta Young, Jack Oakie. 1935.

**11:30 PM - Ch. 7: MOVIE: 'The Rose Tattoo'** A robust Italian born widow of a truck driver baffles her friends with her endless mourning and her Spartan watchfulness over her teen-age daughter. Anna Magnani, Burt Lancaster. 1955.

**12:00 AM - Ch. 8: MOVIE: 'The Marriage-Go-Round'** A Swedish beauty selects her American host, a happily married professor, to father her baby. Susan Hayward, James Mason, Julie Newmar. 1961.

**2:00 AM - Ch. 8: MOVIE: 'Portrait of a Mobster'** The story of the rise and fall of gangster Dutch Schultz. Vic Morrow, Leslie Parrish, Peter Breck. 1961.

**9:00 AM - Ch. 8: MOVIE: 'Code of Scotland Yard'** A crook escapes from Devil's Island. Diana Dors, Oscar Homolka. 1948.

**9:00 AM - Ch. 9: MOVIE: 'The Lady Eve'** The naturalist son of a wealthy tycoon comes out of the jungle to fall into the hands of a girl and her card shark father. Barbara Stanwyck, Charles Coburn, Henry Fonda. 1941.

**11:30 AM - Ch. 8: MOVIE: 'The Daughter of Rosie O'Grady'** The daughter of an ex-vaudevillian, forbidden to try for a stage career, is drawn to it by the nostalgia, music and gay lights of the period. June Haver, Gordon MacRae, Debbie Reynolds. 1950.

**4:30 PM - Ch. HBO: MOVIE: 'The Promise'** Romance concerning the lives of two young lovers after a tragic car crash. Kathleen Quinlan, Stephen Collins. 1979.

**7:00 PM - Ch. 8: MOVIE: 'What Price Glory?' WW I comedy-drama of hot-tempered Captain Flagg and boisterous, brawling Sgt. Quirt. James Cagney, Dan Dailey, Corinne Calvet. 1926.**

**7:00 PM - Ch. 9: MOVIE: 'Backlash'** After five men die in an Apache raid, the townspeople search for the one survivor who is reported to have a fortune in gold. Richard Widmark, Donna Reed, William Campbell. 1956.

**7:30 PM - Ch. HBO: MOVIE: 'National Lampoon's Animal House'** College isn't all fun, but don't tell the guys at Delta House. John Belushi, Tim Matheson. 1978.

**11:00 PM - Ch. 9: MOVIE: 'Cast a Giant Shadow'** An advisor to President Roosevelt is persuaded by an agent for Israel to undertake the training of Israeli soldiers. Kirk Douglas, Frank Sinatra, Yul Brynner. 1966.

**11:00 PM - Ch. HBO: MOVIE: 'Fouly Play'** Assassins are plotting to kill the Pope and two people must prevent the murder. Goldie Hawn, Chevy Chase, Burgess Meredith. 1978.

**12:30 AM - Ch. 8: MOVIE: 'Charlie Chan in Panama'** International spies meet their match in Charlie Chan. Sidney Toler, Jean Rogers, Jack LaRue. 1940.

TUESDAY 04/01/80

**9:00 AM - Ch. 8: MOVIE: 'The Great Garrick'** London's greatest actor is made to look ridiculous when he performs in Paris in the Comedie Francaise. Brian Aherne, Olivia de Havilland, Lana Turner. 1937.

**9:00 AM - Ch. 9: MOVIE: 'Claudia'** A young married couple finds courage when they learn that Mother is dying. Dorothy McGuire, Robert Young, Ina Claire. 1943.

**11:30 AM - Ch. 8: MOVIE: 'The Swinger'** A young girl writer devises a lurid, depraved story and claims it to be her true story. Ann-Margaret, Tony Franciosa. 1966.

**7:00 PM - Ch. 8: MOVIE: 'The Wrong Man'** Two people are caught in an amazing web of mistaken identity. Henry Fonda, Vera Miles, Anthony Quinn. 1957.

**7:00 PM - Ch. HBO: MOVIE: 'Convoy'** It's the truckers versus the cops in a war on wheels. Kris Kristofferson, Ali MacGraw, Ernest Borgnine. 1976.

**8:00 PM - Ch. 13: MOVIE: 'Big Jake'** A cowboy teams up with his sons to track down the gang that kidnapped his grandson. John Wayne, Richard Boone, Maureen O'Hara. 1971.

**9:30 PM - Ch. HBO: MOVIE: 'Plague'**

**10:30 PM - Ch. 8: MOVIE: 'Dust Be My Destiny'** A bitter ex-con starts life anew with his young wife but is arrested for murder. John Garfield, Priscilla Lane. 1939.

**11:00 PM - Ch. 9: MOVIE: 'The Ceremony'** A man is sentenced to die for murder committed during a bank holdup. His brother and girl friend plan his escape. Laurence Harvey, Sarah Miles, Robert Walker, John Ireland. 1963.

**12:00 PM - Ch. HBO: MOVIE: 'Convoy'**

**12:30 AM - Ch. 7: MOVIE: 'Having Babies II'** Emotional crises involving birth, adoption and first love affect the lives of several couples. Tony Bill, Wayne Rogers, Carol Lynley. 1977.

**12:30 AM - Ch. 8: MOVIE: 'John Goldfarb, Please Come Home'** A pilot dubbed 'wrong-way' and a magazine photographer-writer dubbed 'iceberg' get together when she is smuggled into a harem. Shirley MacLaine, Peter Ustinov, Richard Crenna. 1965.

**1:30 AM - Ch. 9: MOVIE: 'Shanghai Express'** An adventures, a medical doctor and a motley crowd of passengers run into rebels. Marlene Dietrich, Clive Brook, Warner Oland. 1932.

**2:30 AM - Ch. 8: MOVIE: 'Winter Meeting'** A disillusioned poetess loves a war hero with a terrible memory. Bette Davis, Jim Davis. 1948.

WEDNESDAY 04/02/80

**9:00 AM - Ch. 8: MOVIE: 'Desert Sands'** An Arab brother and sister lead forces on an attack on a Foreign Legion fort, believing the French killed their father. Ralph Meeker, Ron Randall, Maria English, J. Carol Naish. 1955.

**9:00 AM - Ch. 9: MOVIE: 'Yank in the R.A.F.'** An American flier joins the R. A. F. to be near a chorus girl in a London show. Betty Grable, Tyrone Power, John Sutton. 1941.

**11:30 AM - Ch. 8: MOVIE: 'Till We Meet Again'** Convicted murderer and a girl, with only a few months to live, meet and fall in love aboard a ship. Merle Oberon, George Brent, Pat O'Brien. 1940.

**5:30 PM - Ch. HBO: MOVIE: 'All the President's Men'** Reporters Woodward and Bernstein race for the story behind the Watergate break-in. Robert Redford, Dustin Hoffman, Jason Robards. 1976.

**7:00 PM - Ch. 9: MOVIE: 'Seminole'** A lieutenant assigned to a fort in Florida tries to stop his commander from moving against the Indians. Rock Hudson, Anthony Quinn, Barbara Hale. 1953.

**8:00 PM - Ch. 13: MOVIE: 'Belle Starr'** Belle Starr, an outlaw, tries to make a home to raise her two sons with her Indian husband. Elizabeth Montgomery, Cliff Potts, Michael Cavanaugh. 1980.

**10:30 PM - Ch. 8: MOVIE: 'The Fallen Sparrow'** The sole surviving member of the International Brigade, active in the Spanish Civil War, finds himself trapped by Nazi spies who believe he has a valuable medalion. Maureen O'Hara, Walter Slezak, John Garfield. 1943.

**10:30 PM - Ch. HBO: MOVIE: 'National Lampoon's Animal House'** College isn't all fun, but don't tell the guys at Delta House. John Belushi, Tim Matheson. 1978.

**11:00 PM - Ch. 9: MOVIE: 'Broken Lance'** A Texas cattle baron finds his peace disintegrating when a conflict arises between the sons of his first and second marriage. Richard Widmark, Spencer Tracy, Robert Wagner. 1954.

**12:30 AM - Ch. 8: MOVIE: 'Apache Territory'** A drifter crossing the Arizona desert roots a band of marauding Apaches and rescues a young girl, sole survivor of a wagon train. Rory Calhoun, Barbara Bates, John Dehner. 1958.

**1:30 AM - Ch. 9: MOVIE: 'Edge of Doom'** A young man, caught in the emotional chaps of poverty gropes against society and the church. Dana Andrews, Farley Granger, Maia Powers. 1950.

**2:00 AM - Ch. 8: MOVIE: 'Calypso Heat Wave'** A Calypso idol quits a record company when he finds a racketeer trying to take over. Johnny Desmond, Betty Anders, Paul Langton. 1957.

THURSDAY 04/03/80

**9:00 AM - Ch. 8: MOVIE: 'Drango'** Major, assigned to a small Georgia town he had ravaged during the Civil War, tries to govern without the use of a gun. Jeff Chandler, Joanne Dru, Julie London, Ronald Howard. 1957.

**9:00 AM - Ch. 9: MOVIE: 'The Deadly Bees'** A singer goes to a desolate island for a rest and meets a mad scientist who breeds deadly bees. Suzanna Leigh, Guy Doleman, Catherine Finn. 1967.

**11:30 AM - Ch. 8: MOVIE: 'Dangerous Exile'** A rogue saves a King from the guillotine with the help of an English girl during French Revolution. Louis Jourdan, Belinda Lee. 1958.

**4:30 PM - Ch. HBO: MOVIE: 'Take Down'** A lighthearted film concerning the antics of an inept high school wrestling team. Edward Herrman, Lorenzo Lamas, Kathleen Lloyd. 1979.

**7:00 PM - Ch. 8: MOVIE: 'PHFFFT'** Bored after eight years of marriage, a couple divorces only to find they miss each other. Judy Holiday, Jack Lemmon, Kim Novak. 1954.

**7:00 PM - Ch. HBO: MOVIE: 'Oliver's Story'** Oliver picks up the pieces after his wife's death in this sequel to 'Love Story'. Ryan O'Neal, Candice Bergen. 1978.

**8:30 PM - Ch. HBO: MOVIE: 'The Promise'** Romance concerning the lives of two young lovers after a tragic car crash. Kathleen Quinlan, Stephen Collins. 1979.

## SPECIALS

SUNDAY 03/30/80

**2:00PM - 5 - Shakespeare Plays: Henry IV, Part I**

**8:30PM - HBO - HBO Sneak Preview**

TUESDAY 04/01/80

**5:00PM - HBO - HBO Sneak Preview**

**9:00PM - 27 - Barbara Walters Special**

**10:30PM - 13 - CBS News Special**

**11:30PM - 2 - The 80 Vote**

**12:00AM - 7 - The 80 Vote**

WEDNESDAY 04/02/80

**3:30PM - 2 - AfterSchool Special: Home Run for Love**

**7:00PM - 13 - Bugs Bunny Easter Special**

**8:00PM - 5 - Great Performances: Bach: The St. John Passion**

**12:00AM - 5 - Great Performances: Bach: The St. John Passion**

THURSDAY 04/03/80

**9:00AM - 13 - Magazine**

**10:15 PM - Ch. HBO: MOVIE: 'Take Down'** A lighthearted film concerning the antics of an inept high school wrestling team. Edward Herrman, Lorenzo Lamas, Kathleen Lloyd. 1979.

**10:30 PM - Ch. 8: MOVIE: 'Nobody Lives Forever'** A returned soldier works his charms on a wealthy widow. John Garfield, Faye Emerson, Geraldine Fitzgerald. 1946.

**11:00 PM - Ch. 9: MOVIE: 'Secret Ways'** An American adventurer goes into Hungary, behind the Iron Curtain, to bring out the leader of anti-Communist forces. Richard Widmark, Sonja Ziemann, Charles Regnier. 1961.

**12:30 AM - Ch. 8: MOVIE: 'Charge of the Lancers'** When the British retreat at Sebastopol, two officers, who had brought a cannon to crash the walls, flee to the forest and are hidden by gypsies. Jean Pierre Aumont, Paulette Goddard. 1954.

**1:30 AM - Ch. 9: MOVIE: 'The Strange Door'** Cruel tyrant, subject to fits of insanity, vows revenge of his dead sweetheart by keeping her husband prisoner in the castle dungeon. Charles Laughton, Boris Karloff, Sally Forrest, Richard Stapley. 1952.

**2:00 AM - Ch. 8: MOVIE: 'China Venture'** At the end of World War II, a small force of Marines is sent to capture a Japanese Admiral and bring him to the U.S. for questioning. Edmond O'Brien, Barry Sullivan, Jocelyn Brando. 1955.

FRIDAY 04/04/80

**9:00 AM - Ch. 8: MOVIE: 'Higher and Higher'** A man, unable to pay his servants, forms a corporation with them. Michels Morgan, Frank Sinatra, Jack Haley, Victor Borge. 1943.

**9:00 AM - Ch. 9: MOVIE: 'Hilda Crane'** A young woman returns home to re-evaluate her life after two illated marriages. Jean Simmons, Guy Madison, Jean Pierre Aumont. 1956.

**11:30 AM - Ch. 8: MOVIE: 'The Spanish Gardener'** A father resents the devotion of his son toward their gardener and is drawn toward desperate steps. Cyril Cusack, Dirk Bogarde. 1957.

**4:30 PM - Ch. HBO: MOVIE: 'Plague'** A scientific experiment produces a plague which spreads throughout the city. Daniel Pilon, Kate Reid.

**7:00 PM - Ch. 9: MOVIE: 'The Blob'** Two teenagers after noticing a shooting star fall to earth come upon a man howling with pain from a mass attached to his arm where the meteorite fell. Steve McQueen, Aneta Corsaut. 1958.

**7:00 PM - Ch. HBO: MOVIE: 'Bugs Bunny/Road Runner Movie'** Bugs reminisces about some of his antics with the Road Runner and his other cartoon cohorts in this blend of new animation and classic footage. 1979.

**8:00 PM - Ch. 2: MOVIE: 'Island of Dr. Moreau'** A seaman becomes involved in the bizarre experiments of a scientist trying to isolate the chromosomes which determine the

shape of all living things. Burt Lancaster, Michael York, Nigel Davenport. 1976.

**8:30 PM - Ch. 8: MOVIE: 'Constantine and the Cross'** Constantine declares the Edict of Tolerance when he becomes Emperor of Gaul. He defeats the Roman legions, assuring freedom of worship for Christians. Cornel Wilde, Belinda Lee, Christine Kaufmann. 1960.

**8:30 PM - Ch. HBO: MOVIE: 'Convoy'** It's the truckers versus the cops in a war on wheels. Kris Kristofferson, Ali MacGraw, Ernest Borgnine. 1976.

**11:00 PM - Ch. 8: MOVIE: 'Mysterious Island'** Five men escape from a Confederate prison in an observation balloon and find themselves on a South Seas' island. Joan Greenwood, Michael Craig, Michael Callan. 1961.

**11:00 PM - Ch. 9: MOVIE: 'Run for the Sun'** A girl reporter flies to a remote Mexican fishing village and runs into a Nazi hideout. Richard Widmark, Jane Greer, Trevor Howard. 1956.

**11:00 PM - Ch. HBO: MOVIE: 'Buckstone County Prison'** An expert tracker of escaped convicts is unjustly sentenced to a jail term. Earl Owensby. 1978.

**12:00 AM - Ch. 13: MOVIE: 'Man From Colorado'** A sadistic army officer is appointed as a federal judge and uses his power to torture and kill. Glenn Ford, William Holden, Ellen Drew. 1948.

**1:30 AM - Ch. 8: MOVIE: 'Sherlock Holmes in the House of the Baskervilles'** The curse of an English noble family descends to each man who inherits the title. Holmes is called in to protect the latest heir. Richard Greene, Basil Rathbone, Nigel Bruce. 1939.

**1:30 AM - Ch. 9: MOVIE: 'The Accused'** A woman psychology teacher becomes subjected to the suspicions of the police, in trying to cover up an accidental killing of a forward pupil. Loretta Young, Robert Cummings, Wendell Corey. 1948.

**3:30 AM - Ch. 8: MOVIE: 'Berlin Correspondent'** A newspaperman in Berlin endangers his life to rescue a professor from the Nazis and then escapes with him and the girl he loves. Dana Andrews, Virginia Gilmore, Mona Maris. 1942.

## SPORTS

SUNDAY 03/30/80

**12:00PM - 13 - NBA Basketball: Boston at Philadelphia**

**12:30PM - 8 - Exhibition Baseball: Atlanta vs. Cincinnati**

**1:00PM - 2 - Superstars**



THE BEST SEAT IN THE HOUSE

**Dairy Queen**  
Baxter, Frances & Stacy Laymance  
W. Highway 60 Ph. 247-3838

**Parmer County Implement**  
INTERNATIONAL AGRICULTURAL EQUIPMENT

**Curtis Mathes Showroom**  
149 N. 25 Mile Ave. Hereford, Texas

**Friona Ford Sales, Inc.**  
FORD

**Kendrick Oil Company**  
PHILLIPS 66

Featuring Breakfast & Lunch  
Open 6 days a week, 7 a.m.-5 p.m., 7 a.m.-3 p.m. Saturdays.  
We feature a different lunch menu daily. \*Chicken Fried Steaks, \*Chicken Strips, etc. \*Sandwiches, \*Fountain Drinks. \*Ask us for a "half order."  
**GEE'S SNACK BAR** at Bi-Wize Drug

**Tasty Cream**  
After School Or Anytime! Ph. 247-3060

**POOR BOY'S PIT BARBECUE**  
For The Best In  
★ Pit Barbecue ★ Mexican Food  
Watch For The Opening Of Poor Boy's Play-O-Rama

Would You Like An Ad Seen By 4500 Local Readers Each Week? Call The Star For A Spot.

**Co-op Service Station (Friona Consumers)**  
FUELS Now Open All Day Saturday Mon.-Sat. 7:30 - 6 P.M.

See Our Anniversary Specials On Page 5!!  
Wilhelm TV & Appliance

**Horn-Clayton Insurance**  
YOUR Independent Insurance AGENT  
CARROL GATLIN AGENCY MANAGER

**The Splatter Shack**  
517 Main-Friona  
Lorene Ray's Class Will Be April 17-18-19

**Reeve Chevrolet-Olds**  
GM QUALITY SERVICE/PARTS GM GENERAL MOTORS PARTS DIVISION

**Jones Painting**  
Glendel Jones Ph. 247-3458  
★ Commercial ★ Residential

**Friona Donut Shop**  
W. Hwy. 60 Ph. 247-3296

**True Value Hardware**  
True Value HARDWARE STORES

**Tri-County Elevator**  
Black, Texas Bill Thornton, Mgr. Come By And Get Acquainted!!

**Ruthie's**  
Ladies & Children's Wear

**Robertson Electric**  
W. Hwy. 60 Friona, Texas Ph. 247-2169



**BARBARA NELL FULKS and JESSIE CARL WHITLOW...** Mr. and Mrs. J. Vonne Fulks announce the engagement of their daughter, Barbara Nell to Jessie Carl Whitlow, son of Mr. and Mrs. Jerry B. Whitlow of Winters, Texas. Miss Fulks is a 1976 graduate of Friona High School and a candidate for December graduation from Angelo State University. Whitlow is a 1977 graduate of Winters High School and is currently employed by Concho Valley Electric Coop in San Angelo.

## Hospital Report

### ADMISSIONS--

Guadalupe Raymond, Friona; Antonia Baca, Bovina; Toby Strickland, Friona; Elmer Northcutt, Friona; Buddy Lloyd, Friona; Maria Cruz and baby girl, Friona; Pearl Hand, Friona; Quayle Duggan, Friona; Ernie Saldana, Friona;

Claude Blackburn, Friona; Joe Beaty, Friona; Pearl Grissom, Friona; Geraldine Greer, Friona;

Leontina Padilla, Earth; Eugene Boggess, Friona; Lacy Venhaus, Friona; Adilon Ramirez, Friona; and Flora Vega, Friona.

### DISMISSALS--

Yolanda Walker, Donna Fallwell, Ann Schloss, Jennifer Woody and baby boy, Fannie Southall, Elmer Northcutt, Toby Strickland, Antonia Baca, Edward Bagot, Buddy Lloyd, Eugene Gulley, Quayle Duggan, Pearl Allen, Guadalupe Raymond, Maria Cruz and baby girl, Ernie Saldana and Joe Beaty.

### PATIENTS IN HOSPITAL--

Pearl Hand, Ethel Bengler, Claude Blackburn, Geraldine Greer, Pearl Grissom, Adilon Ramirez, Flora Vega, Eugene Boggess, Leontina Padilla, Lacy Venhaus and Bess Rea.

## Eight Attend Society Meeting

St. Teresa's Ladies Society met for their monthly meeting at the Parish Hall Monday, March 24.

Hortencia Bermea, vice president, opened the meeting with a prayer. She also conducted the meeting, due to the illness of Matilda Baca, president.

Seven members and one guest, Romona Bautista, were present. Silvia Roth gave a report on the D.C.C.W. Board meeting that was held at Nazareth on March 4. Delegates that will attend the Spring Denney Meeting in Bovina are Helen Fangman, Romona Bautista, Angela and Hortencia Bermea.

The Ladies Society will serve as hostesses for the First Holy Communion Class and their families on May 11. Sylvia Roth volunteered to be chairman for the paschal meal that will take place at the Parish Hall Wednesday, April 2 after the 7 p.m. mass.

General church cleaning will be done Wednesday, April 2 at 9 a.m. All ladies of the parish are invited to come and help. In other business Sylvia Roth gave the Senior Citizens report. A thank you note was read from Mary Lou Venhaus.

Susie Perez and Adriana Garza

were appointed as church cleaners for April and Susie Perez will be the hostess for the next meeting.

Refreshments were served to Romona Bautista, Mary Alvarado, Helen Fangman, Sylvia Roth, Matilda Caballero, Hortencia Bermea and Angela Bermea, by the hostess, Irene Bermea.

## It's A Girl For Stones

Mr. and Mrs. Steve Stone became parents of a baby girl on February 27. Named Somer Renee, the new arrival weighed seven pounds, 12 and 3/4 ounces. She was born at Palo Duro Hospital in Canyon.

Somer Renee is the first child for the couple.

Grandparents are Mr. and Mrs. Travis Stone of Black and Mr. and Mrs. Herman Carlisle of San Antonio.

Great-grandparents are Mr. and Mrs. Cecil Reagan and Mr. and Mrs. Herman Carlisle, all of Uvalde, and Mrs. Ruby Inken of Uvalde is a great-grandmother.



**SYLVIA MALOUF and CRIS INGRAM...** Mr. and Mrs. Hanna Malouf and Mr. and Mrs. W.S. Ingram are announcing the engagement and approaching marriage of their children, Sylvia and Cris. The wedding will take place at 4 p.m. on May 4 at St. Teresa's Catholic Church in Friona. Sylvia is a 1978 graduate of Friona High School, and Cris is a 1977 graduate of FHS. The bridegroom is engaged in farming.

## Local Boys Perform At Amarillo

Two Friona youths are members of a musical group which is currently playing at the Copper Creek Restaurant in Amarillo, through Saturday, March 29.

The group, "Essence," is playing at the restaurant's "Praise Room," from 6-9 p.m. The Copper Creek Restaurant is located at 4418 S. Washington (Southlawn Plaza), Amarillo.

Members of the group are Bryan Johnston, Clint Mears, Rocky Gilmore and Mike McFarland. They play contemporary gospel music.

## EASTER BASKETS OF Bargains



New! By Sasco  
**Aloe Vera Liquid**  
Liquid, Hand Cream, Gel,  
Body Wash And Body Silk

Complete Supply of  
**Easter Baskets, Candies, Cards Etc.**



New Order Of Coty  
**Colognes**



Soft Hold  
**Final Net**  
8 Oz. \$2.06

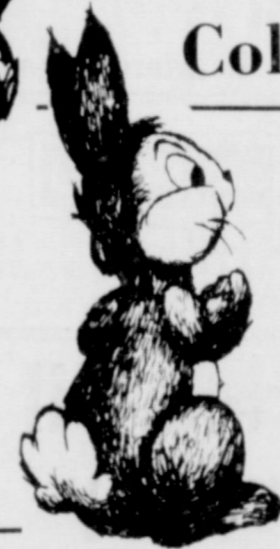

Extra Strength  
**Sinutab** 24 Ct.  
Reg. \$3.13  
**\$2.42**



Just Arrived! New Shipment Of  
**Dex-A-Diet II, Dexatrim**  
And Permathene - 12.  
**Reducing Plans**

We Are  
Discontinuing  
**Air Maid Hose**



**BI-WIZE** REXALL **DRUG**

619 MAIN

PH. 247-3010

## Don't Start That SPRING CLEANING

Until You've Purchased Your

Janitorial Supplies From Our Annual

**Friona Noon & Evening Lions Clubs'**

**MOP and BROOM**

**SALE**

ALL DAY

**Tuesday, April 1**

Our Truck Will Be Parked At The City Park

Starting At 10 a.m. Lion's Club Members Will

Be Knocking On Doors Starting At 5 p.m.



- ★ BAGS ★ MITTS
- ★ DUST CLOTHS
- ★ WASH CLOTHS
- ★ BROOMS ★ MOPS
- ★ IRONING BOARD COVERS
- ★ IRONING BOARD COVER & PAD SETS
- ★ WAX APPLICATORS
- ★ REFILLS ★ BRUSHES
- ★ LAWN RAKE
- ★ POT HOLDERS
- ★ DISH TOWELS
- ★ SCRUBEEZ
- ★ UTILITY SPONGE
- ★ HANDLES
- ★ POLY SWEEP

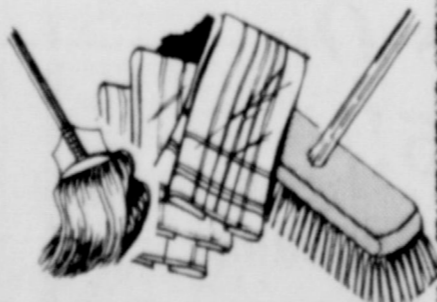

**CARAVAN SALES FOR THE BLIND**  
ALL ARTICLES MADE BY THE BLIND

SPONSORED BY LOCAL **LIONS CLUB**





Mr. and Mrs. Henry Lewis

## Reception Honored H. Lewises

The Golden Wedding Anniversary of Mr. and Mrs. Henry Lewis of 807 Columbia, Friona, was celebrated on Sunday, March 23, with a reception from 3-5 p.m. in the home of Mr. and Mrs. D.C. Herring.

The former Ula Jones married Henry Lewis on March 22, 1930, at the First Methodist Church parsonage in Friona. Rev. Joshua Jones married the couple. There were three members of each of their families present.

Henry and "Tom" were both from Celeste, Texas, but Henry had preceded her to Friona and was engaged in farming near Friona. The couple has lived in Friona for all of their 50 years of married life.

Mrs. Lewis retired from Harvey, Messenger & Co., an accounting firm, in May of 1976, but is presently employed at Ruthie's. Henry retired from Herring Implement Company in 1976.

The Lewises belong to the Friona United Methodist Church. Henry has belonged to the Lions Club, the Masonic Lodge and Chamber of Commerce. Tom has been a member of the Modern Study Club and the Eastern Star.

They are parents of a son, Don, or Del, better known to Friona residents as the director of the Summer Drama Workshop. Del graduated from Friona High School in 1955 and is presently the professor of music and drama at East Carolina University, Greenville, N.C.

More than 150 guests were present to help the couple celebrate.

Out of town guests included Mr. and Mrs. Bob Gooch of Canyon, Mr. and Mrs. Tommy Braddy of Hereford, Mr. and Mrs. Charles Luna of Dallas, Mr. and Mrs. Harold Thompson of Abernathy, Mr. and Mrs. Henry Goen of Greenville, Ben Konis and daughter Jade of Amarillo and Lisa Taylor Miller of Waco.

Hosts and hostesses for the occasion were Mr. and Mrs. Jack Moseley, Mr. and Mrs. Wesley Foster, Mr. and Mrs. Tom Shelton and Mr. and Mrs. Herring.

# Easter BARGAIN Time

Extra Large Eggs **71¢** Borden's Ice Cream **\$1.59**

Hand Lotion **Wondra** 15 Oz. Reg. Or Unscented **\$1.39**

Toothpaste **Crest** Reg. Or Mint **\$1.19** 7 Oz. Tube

Cannon Mills **MARTINIQUE COLLECTION** Coordinated Sheets-Towels-Cases

Sergeants Dog And Cat Flea Collar Reg. \$2.99 **\$1.69**

"We are introducing Cannon's newest fashion look for the bedroom and bath. The sheet is a polyester/cotton blend in Cannon's famous percale quality. The bath towel ensemble that coordinates with it is an oversized printed velour with a heavy dobby border. Fashion colors blue and parchment."

Twin, flat and fitted	5 <sup>00</sup>	King cases	5 <sup>00</sup> Per Pr.
Full, flat and fitted	7 <sup>00</sup>	Bath towel	3 <sup>00</sup>
Queen, flat and fitted	9 <sup>00</sup>	Hand towel	2 <sup>00</sup>
King, flat and fitted	12 <sup>00</sup>	Wash cloth	1 <sup>00</sup>
Regular cases	4 <sup>00</sup> Per Pr.		

Igloo Little **PLAYMATE COOLER** 2 colors to select Reg 9.89 **6.99**

Kordite **Wastebasket Bags** 4 Gal. **\$1.49** 60 Ct.

Kodak C110 **Film** 24 Exposure **\$2.19**

Girls' Wood Style **Sandals** Size 10 To 3 **\$9.99**

Ekco "Top Drawer" **Kitchen Tools** Close Out Your Choice **99¢**

Ladies 100% Natural Leather **Sandals** **\$11.99**

**Black & Decker** Nylon Line **GRASS TRIMMER** Model 8206 **\$12.99**

Trims grass and light weeds along fences, against walls, around trees and gardens. High speed nylon line, safer than a blade. Spool designed for fast and easy advancing of nylon cutting line lengths. Quick spool replacement. Enough line included for one season's use. 2 1/2 lbs. net wt.

Kodak Instant Camera **Colorburst 300** **\$59.99**

**Flash Bar** **\$1.89**

**Flip Flash** **\$1.39**

**Magicubes** **\$1.29**

**GIBSON'S Sandra Savings Center** Friona, Texas --- Ph. 247-3957

WE SELL **VISA** **Kodak** **master charge** CAMERAS FILM

Store Hours **9 A.M. - 7 P.M.**

IT PAYS TO PLANT **Paymaster**

**GR 1018** Greenbug resistant hybrid grain sorghum. ★ Delivers high yields ★ Early maturity

**GR 108** Hybrid grain sorghum ★ Produces consistently high yields ★ Short, sturdy stalks support large heads of heavy grain of excellent feeding quality ★ Drought and greenbug tolerant

For more information contact: **WEST FRIONA GRAIN RHEA FEED & GRO. FRIONA WHEAT GROWERS BREUGEL BROS. GIN & ELEVATOR**

"Block goes with me to the IRS? Free? I shoulda come here last year."

We're trained to know every deduction and credit the law allows. And if the IRS calls you in, we'll go with you, free. Not as a legal representative but to explain how your taxes were prepared.

**H&R BLOCK** THE INCOME TAX PEOPLE

511 Main Street, Friona Phone 247-3638 Open 9 A.M.-6 P.M. Weekdays 9 A.M.-1 P.M. Saturday

**Prairie Acres Party Line**

Hello Central: We're glad to have Buford and Jean Hartwick home. They've been visiting in the Dallas area. They're our unofficial "fixer-uppers" and spend a great deal of time helping out with odd jobs. We miss them when they're away.

Paul Griffith is still hospitalized.

Mrs. Lamecia Ozuna has gone back to her home.

Eugene Gulley passed away recently.

Special thanks this week go to Friona State Bank, for sending yellow roses to each of our residents having birthdays this month.

Our April birthday people are Kay Kendrick, who will be 84 April 25; and J.E. Stengel, who will have his 94th birthday April 2.

Our newest resident is Mrs. Pearl Allen of Duncan, Oklahoma. Mrs. Allen is a former resident of the Hub Community and is the mother of Charles Allen.

**Ask the Land Bank about...** money to buy land or improve your farm.

Farmers today are looking at ways to increase their productivity... buying or improving land... building or remodeling facilities. Whatever way you choose to grow, the Federal Land Bank can provide long term credit to help.

So when you're looking to buy or build, stop in and talk to the long-term farm credit specialists at your Land Bank Association.

**The Land Bank** **Federal LAND BANK Association**

Bill Liles, Manager FLBA of Muleshoe 316 Main, Muleshoe Phone 272-3010

## JH UIL Contestants Compete At Olton

Friona Junior High students competed in University Interscholastic League (UIL) events Friday at Olton.

### It's A Girl

### For Spencers

Mr. and Mrs. Raymond Spencer, Route 3, Friona, became parents of a baby girl at 6:38 a.m. Thursday, March 20 at Deaf Smith General Hospital, Hereford.

She weighed seven pounds, eight ounces and was twenty-one inches long. She was named Tammy Kay.

Mr. and Mrs. J.D. Spencer Sr. of the Black Community, J.C. Snitker of Bula, Texas, and Carolyn Snitker of Sunray are the baby's grandparents.

Great-grandparents are C.C. Snitker of Bula and Mr. and Mrs. Lloyd Jones of the Black Community.

Tammy is the first child for the Spencers.

The participants were announced this week by junior high principal Cecil Maddox.

Following are the contestants, by event:

Oral reading: grades five and six--Susan Bailey, Tracie Zoth and Rachel Bermea. Grades seven and eight--Jessica Maurer, Shelia Gresham, and Brent Hinkle.

Spelling and plain writing: grades five and six--Brad Moyer, Jeana Mason and Sonia Lafuente. Grades seven and eight--Julie Wilshire, Sarita Ellis and Kevin Brogden.

Ready writing: grades five and six--Wendy Hinkle, Melanie Gallman and Kelly Wied. Grades seven and eight--Kristi Herring, Diane Johnston and Debbie Reeve.

Number sense: Kevin Brogden, Wade Davenport and Bill Caudill.

Story telling: Lori Riley, Krista Renner and Bill White.

Picture memory: Glenda Ellis, Kathy Boeckman, Shannon Atwell, Sheila O'Brian and Leigh Ann Neelley.



MR. and MRS. RAMON VEGA...Mr. and Mrs. Ramon Vega celebrated their 60th wedding anniversary recently in their home in Lubbock, with their sons and daughters. The couple was married in Runge, Texas in 1920. They have seven sons, Luis, Francisco, Eligio, Ramon Jr., Celestino, Isidro and Benito, three daughters, Aurora Campbell, Adelaida Davilia and Audelia Rivera of Friona. They also have 69 grandchildren and 27 great-grandchildren.

## Lutheran Church To Observe Holy Week

The observation of Holy Week at Redeemer Lutheran Church, Friona, will begin Sunday at 2:30 with a worship service conducted by Pastor Ed Brown.

The message is entitled "The Cross Before The Crown" and is based on Luke 22:23-30 and Philippians 2:5-11. Sunday School will follow at 3:45. A special Christian Passover will be celebrated on Maunday Thursday at 7:30 p.m. Good Friday services will

be held at Immanuel Lutheran, Rhea, at 9:30 a.m.

Easter will be celebrated by a sunrise festival of worship at 7 a.m. There will be a special children's program following worship. A pancake and sausage breakfast will be served by the Men's Club. Anyone who worships Jesus is Lord is welcome, and will feel at home with us.

Have you heard?

ANNOUNCING  
NEW SHARE  
CERTIFICATES  
COMPARE OUR  
YIELDS

7.25% Annually Paid on Six Month Certificates \$1,000 Min.	7.50% Annually Paid on Six Month Certificates \$5,000 Min.	7.75% Annually Paid on Six Month Certificates \$10,000 Min.
---	---	--

A Substantial Penalty If Withdrawn Early

Federal Regulations prohibit payment of dividends in excess of available earnings.

FRIONA TEXAS  
FEDERAL CREDIT UNION

Ph. 247-2736 6th & Euclid

### Girl Is Born To Joel Osborns

Dr. and Mrs. Joel Osborn of Jackson, Mississippi, became parents of a baby girl at 6:33 p.m. Thursday, March 6.

She was named Loren Colin, weighed nine pounds, two ounces and was twenty-one inches long.

Loren has one brother, Erin, who is two and one half. Her grandparents are Mr. and Mrs. Ernest Osborn of Friona.

Mr. and Mrs. J.L. Shaffer are the baby's great-grandparents.

Mrs. Osborn is the former Carleen Greeson.

WE RESERVE THE RIGHT TO LIMIT PRICES EFFECTIVE MARCH 24-29, 1980  
SPECIALS GOOD WHILE SUPPLY LASTS - LIMITED SUPPLY

## SECOND BIG WEEK!

# Save into Spring SALE

<b>BORDEN'S COTTAGE CHEESE</b> 12 OZ. CTN. <b>79¢</b>	\$1.59				
<b>BORDEN'S ASSORTED ICE CREAM</b> 1/2 GAL. RD. CTN.					
<b>SHURFRESH BUTTERMILK SWEET MILK BISCUITS</b> 7 8 OZ. CANS <b>\$1.00</b>	<b>SHURFRESH HALF MOON COLBY LONGHORN CHEESE</b> 10 OZ. PKG. <b>\$1.09</b>				
<b>COOKED FOOD SPECIAL</b> <b>Chicken Strips</b> <b>99¢</b>	<b>SHURFINE CUT GREEN BEANS</b> 3 16 OZ. CANS <b>\$1.00</b>				
<b>SHURFINE FLOUR</b> 5 LB. BAG <b>69¢</b>	<b>SHURFINE CREAM STYLE WHOLE KERNEL GOLDEN CORN</b> 5 17 OZ. CANS <b>\$1.00</b>				
<b>SHURFINE TOMATO SAUCE</b> 6 8 OZ. CANS <b>\$1.00</b>	<b>SHURFINE ELECTRIC PERK REGULAR COFFEE</b> 1 LB. CAN <b>\$2.39</b>				
<b>SHURFINE SALTINE CRACKERS</b> 2 10 OZ. BOXES <b>\$1.00</b>	<table style="width: 100%; border: none;"> <tr> <td style="text-align: center;">Allsup's Bread</td> <td style="text-align: center;">Allsup's Milk</td> </tr> <tr> <td style="text-align: center;">1 1/2 Lb. Loaf <b>2/89¢</b></td> <td style="text-align: center;"><b>\$1.89</b> Gal.</td> </tr> </table>	Allsup's Bread	Allsup's Milk	1 1/2 Lb. Loaf <b>2/89¢</b>	<b>\$1.89</b> Gal.
Allsup's Bread	Allsup's Milk				
1 1/2 Lb. Loaf <b>2/89¢</b>	<b>\$1.89</b> Gal.				
<b>SHURFINE FRUIT COCKTAIL</b> 2 16 OZ. CANS <b>89¢</b>	<b>SHURFINE GROUND BLACK PEPPER</b> 4 OZ. CAN <b>79¢</b>				
<b>BORDEN'S BUTTER MILK</b> 1/2 GAL. CTN. <b>99¢</b>	<b>SHURFRESH QUARTERS MARGARINE</b> 2 1 LB. PKGS. <b>79¢</b>				
<p style="text-align: center;">2-Liter <b>Cokes</b> <b>79¢</b></p>	<b>SHURFINE SPINACH</b> 3 15 OZ. CANS <b>\$1.00</b>				

# introducing

## Tip Carter, Our New Gin Manager

Come By And Get  
Acquainted With Tip In The Near Future.

We Have A Good Supply Of Planting  
Seeds. We Are Now Carrying Several  
Varieties Of Funk's Corn & Milo Seeds  
Plus Other Major Brands Of Cotton Seed.

# Friona Farmers Co-op Gin



# Town Talk

By June Floyd

Call 247-3681 With Your News Item



Tommie and Kathy Boeckman had an interesting experience recently. They were in Headrick, Oklahoma, to visit Tommie's oldest sister, Beulah Ruth Booker and her family. One day they went to a nearby town, Altus, shopping. As the three were walking through a mini mall, Tommie noticed a man who looked familiar to her. Later, Beulah Ruth asked Tommie if she recognized him. She had noticed a kind of "where have I seen you before," look on his face. After a few moments of concentration, Tommie walked back towards the man. It was a few seconds before either of them recognized the other. He was Urschel Perkins, a brother of Friona's Cass and Richard Perkins and a former resident. His wife, the former Iva Jo Brooks is also an ex-Frionian. She was in the mall, too, so Tommie enjoyed renewing acquaintances with the two of them. They live at Tyrone, Oklahoma, and have a custom combining business, which keeps them on the road much of the year. Urschel gave Tommie a business card which read

"Urschel Perkins and daughters, Custom Combine Service." During the "off" months, the two younger daughters work at other jobs, but when it is time to "roll out the combines," they join their Dad and Mother and head for the fields. The couple's oldest daughter, Susie, is married and has one son. While the Boeckmans were in Altus, they also saw Oleta Kelley of Friona, who was there visiting relatives; a sister of Hazel Baxter's, who lives there; and a sister of Marie Perkins, who also lives there.

Sarah Coranado has joined the special category of people who wear the label, "grandparents." This is a very special label, which almost everyone feels honored to wear. Mr. and Mrs. Izzy Cordova of San Antonio have a brand new baby girl. Sarah and her younger children, Denae and Ricky Vera, went down to the Alamo City this past weekend. They were accompanied by Sarah's parents, Mr. and Mrs. Matilde Martinez. According to the report of the proud grandmother and great-grandparents, little Trieste Rene is a

very special baby. Buford and Jean Hartwick took off recently for a visit with relatives and friends in the Dallas-Fort Worth Metroplex area. They visited Buford's mother, Mary Hartwick, a resident of Cedar Hill Retirement Home in Fort Worth; special friends, Cotton and Peggy Brewer, and others in Farmersville, Greenville and other places in that vicinity. Kirk and Ruby Lowe of Amarillo, fishing buddies of Hap and Julia Fairchild, have been visiting in Friona. John and Kathrine Blackburn are home. Kathrine has been on vacation for a couple of weeks. She flew to Birmingham, Alabama, where she visited Mr. and Mrs. Harry Campbell and Mrs. L.E. Price for a week. Mrs. Price is Kathrine's mother and Mrs. Campbell is her sister. Another sister, Carolyn Levinson of Dallas, was also a guest in the Campbell home. From Birmingham, Kathrine flew back to Dallas, where John met her. Then, the two drove to Shreveport, Louisiana for a visit with Craig, Brenda, Cara and Sara, before returning home.

Mrs. Ardith Rolan, the former Dorothy Vaughn, of Stratford, Texas, is visiting in the home of her father, Elwood Vaughn. He is recuperating at home following an extended period of hospitalization. Calvin and Ann Martin had out-of-town visitors last week. Mr. and Mrs. Eugene Nidey and daughters, Lisa Nidey and Brenda Grogan, came down from Campo, Colorado, for the Kathy Martin, J.E. Stone wedding Thursday evening. Brenda's three children, three year old Brandon and twin daughters, Brianna and Brittany, came, too. This was the first Texas trip for the babies, who are four months old. The Kansans returned home Saturday. Mrs. Nidey is the former Marilyn Martin. Residents of the northeast part of town will soon have a new mail carrier. Postmaster Richard Wilson reports that Troy Bass has been selected through a competitive

examination to replace Preston Wiley, who recently transferred to Pampa. He says, "We hope Troy can go to work by the first of April. Everything is in order for his employment except some paper detail." Troy is a local man, who is well known to a lot of us. We're looking forward to having him deliver mail to us. He and his wife, the former Karene Hart, live over at the corner of Main and Fifteenth. Holly and Blaire Jones of Lubbock are visiting in Friona this week. Holly is the daughter of Louis and Mamie Lou Welch. Blaire's other grandmother is Ouida Jones. Menden Dixon was honored with a birthday party, and a trip to Amarillo on Saturday, March 22. The group went to a movie, to eat out, and on the way home, stopped at his sister Melodi's in Canyon, where they opened birthday presents. Those attending were Karla Wright, Melanie Gallman, Leslee Upton, Kelly Wied, Jamie Harris, Susan Bailey, Jeff Brown, Frankie Perez, Curtis Allen, Gerald Kothmann, Brad Moyer, Tony Day, Menden Dixon and the parents, Mr. and Mrs. Jim Dixon. Menden was 12 years old on March 17. Keith Rutherford, son of Ted and Martha Slagle Rutherford of Tucumcari, New Mexico was married recently in Hereford. He and his wife Gina Radtke were married on "Leap Year Day," so will only have an anniversary every four years. Rev. Herschel L. Thurston of Hereford performed the ceremony. Forty years ago he had married Keith's parents in Friona, Texas. Martha's parents were the late Mr. and Mrs. Roy Slagle of Friona. Lodge Chief To Visit Here John Horton of Adrian, who is District Deputy of the Grand Lodge of Texas, will make an official visit to the Friona Masonic Lodge at 8 p.m. on Tuesday, April 1. According to a spokesman for the lodge, an interesting program is scheduled, and all local Masons are urged to attend the meeting and meet Mr. Horton.



**CHRISTINE RENE QUINTANA and BLAYNE DEE BAXTER....Mr. and Mrs. Al Quintana of Saguache, Colorado and Mr. and Mrs. Billy Dean Baxter of Friona announce the engagement and approaching marriage of their children, Christine Rene Quintana and Blayne Dee Baxter. The couple will exchange wedding vows Saturday, May 17 at 2 p.m. in the Saint Joseph Catholic Church, Salida, Colorado. Miss Quintana is a 1978 graduate of Saguache High School and is attending the University of Northern Colorado in Greeley, Colorado. The prospective bridegroom is a 1974 graduate of Friona High School and graduated from Oklahoma State Tech at Okmulgee, Oklahoma in May of 1977. He is currently employed at Merryman Construction in Jal, New Mexico.**

**"TOMORROW'S IDEAS FOR BETTER LIVING TODAY"**

**'1000 GIFT CERTIFICATE**

**HOME SHOWCASE '80**

ADMISSION Adults \$1.00 Students 50c

**APRIL 11, 12 & 13 AMARILLO CIVIC CENTER**

**3 Big Days**

Friday 12 noon - 10 pm  
Saturday 10 am - 10 pm  
Sunday 10 am - 9 pm

**YOU EXPECT US THERE**

Yes you expect us there and You depend on Southwestern Public Service electricity to provide a lot of things to make your life better and more comfortable at home and work.

You depend on SPS to restore service quickly after a storm or accident.

When you need us we'll be there. It's good to know there's something you can depend on.

**SPS**  
SOUTHWESTERN PUBLIC SERVICE

**Congratulations**

**To Our Prize Winners :**

**1st Prize: Jim & Mary Johnston, TV Set Purchased From Wilhelm TV.**

**2nd Prize: Billy Fairchild, Stool Donated By Plains Hardware.**

**3rd Prizes: Betty Pitts, Myra Veazey, Larry Speener And Karen Zachary, Luggage Sets.**

**4th Prize: Betty Talley, A Plant Purchased From Blossom Cottage.**

**5th Prize: Ted Osborn, Candy.**

**6th Prize: Mamie Gee, A Light Donated By Plains Hardware.**

**MOON-LITE**  
Printing & Graphics  
FRIONA'S PRINTING AND OFFICE SUPPLY CENTER  
123 W. 7th Street Friona, Texas 79035 (806) 247-2019

**3184**

**3183**

**plant 'em both**

**3184**

This hybrid's record for consistency has made it one of the most popular hybrids on the High Plains. In 77 comparisons over the last four years against competitive hybrids, 3184 has shown an average yield of 183.7 bu./A. with a yield advantage of 14.3 bu./A. over competitors. Bred with outstanding drought tolerance, 3184 can adjust ear size and kernel depth to match growing conditions. And strong stalks keep 3184 standing straight for speedy harvest. It's just what High Plains farmers need in a dependable, high-yielding corn hybrid. And its maturity makes it a good companion for 3183.

**3183**

Push this one for highest yields! In 43 comparisons on the High Plains in 1979, this hybrid averaged 192.1 bu./A. A sampling of yields from 1979 includes 216 bu./A. for Sheldon Rapp at Hooker, Oklahoma ... 210.4 bu./A. for Larry Kemp of Muleshoe ... and 196.7 bu./A. for Doyle Underwood at Dimmitt, Texas. 3183 has demonstrated very good standability and ear retention in this area. Excellent drought tolerance helps 3183 maintain outstanding consistency year after year. And it has been especially impressive on gray soils. Plant 3183 along with 3184. Spread genetic risks and get top performance, too.

**PIONEER SEEDS**  
Pioneer Hi-Bred International, Inc.  
Southwestern Division

Be sure to ask your Pioneer corn dealer about the Pioneer Poll on Grain Transportation.

## Braves Place First At Olton Meet

The Friona Braves travelled to Olton for their first meet of the season. The eighth grade Braves worked hard and came home with the championship trophy.

The Braves accumulated 180 points to Muleshoe's 153 points. There were only five events the Braves did not win, but they placed in them.

The sprint relay, made up of Kenneth Jones, Eloy Caballero, Nathan Rodriguez and Charlie Morgan, were clocked in 49.3 to take first place.

The mile relay also brought home a trophy, with a winning time of 4:03.8. That team was made up of Eloy Caballero, Reese Fleming, Robert Escalante and Joe Garza.

"Overall it was a very good meet for us and especially a good one to start the season with. The young men really wanted to win this one and went out and did an excellent job," said Coach Jim Hand.

March 21 the Braves will be running in the Bovina Mustangs relay. The results of the other races and field events follows:

Long jump--1. Charlie Morgan, 18'1"; 2. Nathan Rodriguez, 16'9".

High jump--5. Eloy Caballero, 5'; 6. Harvey Lafuente, 5'.

Pole vault--1. Charlie Veazey, 8'6"; 2. Keith May, 8'6"; 6. Thomas Merritt, 7'6".

Discus--1. Robert Escalante, 125'8"; 3. Eloy Caballero, 106'5 1/4".

100 yard dash--1. Charlie Morgan, 11.4; 2. Kenneth Jones, 11.5; 4. Nathan Rodriguez, 11.7.

220 yard dash--3. Kenneth Jones, 27.0; 5. Charlie Morgan, 27.4.

440 yard dash--1. Eloy Caballero, 57.5; 3. Joe Garza, 59.2; 5. Robert

Escalante, 61.6.  
880 yard dash--1. Troy Crutchfield, 2:25.2; 2. Charlie Veazey, 2:25.3; 4. Paul Melton, 2:33.7.

1320 run--1. Julian Hidrago, 3:44.4; 4. Michael Granado, 4:04.3.

## Star Team Wins First

The Friona Star women's volleyball team participated in the Walcott-Sims Volunteer Fire Department's invitational volleyball tournament March 20-22.

The Star team won their third first place trophy of the season after defeating Wrecking Crew from Adrian, Rocking B Fuel from Wildorado and Ag-Chem from Friona.

Team members are Vickie Copley, Lisa Howell, Sharon Gordon, Lucinda Patterson, Jayn Looper and Donita Martin.

Friona Wheat Growers men's team also brought home a first place trophy.

Also placing in the tournament were Ag-Chem's women's team, with second place honors.

Members of the Ag-Chem team are Dian Anthony, Teresa Buske, Jan Petree, Debbie Smith, Vickie Smiley and Cindy Smiley.

## Around The House

By LAURA JACOBS

Last weekend I fixed Mexican food for all of my aunts. While I was looking for a Guacamole salad recipe I came across this great hint. To keep the Guacamole from turning dark while it is waiting to be served, save the large pit from the avocados and bury them in the salad. It works! Not one dark spot on the salad.

Here is the recipe I used:

3-5 avocados  
1/4 teaspoon garlic, grated  
1 small onion, grated  
1 teaspoon salt (to taste)  
1-2 tomatoes  
1 tablespoon lemon juice  
Red pepper sauce (to taste)

Select soft avocados. Peel and mash with the lemon juice, onion and garlic. (I found a pastry blender does a better job of mashing than a fork). Chop tomatoes fine and add with salt and red pepper. Serve on shredded lettuce or as a dip. Mayonnaise may be added if you like.

## It's not too late.

It's not too late to help your community get equal government representation and the funding it needs.

It's not too late to answer the Census.

Answer the Census. We're counting on you.



## Springtime Specials

New Spring Items For  
Men, Women and  
Children.

Special Purchase

## Down Jackets

By Walls Reg. \$75

**\$39<sup>95</sup>** Buy Now  
For Next  
Winter!



ee's WESTERN WEAR

1910 W. Amer. Blvd.  
Muleshoe, Texas Ph. 272-4663

# POARCH'S FURNITURE

"Where only the look is expensive"

618 MAIN FRIONA, TEXAS PHONE 247-2035

•FINANCING AVAILABLE WITH APPROVED CREDIT  
•FREE DELIVERY AND SET UP WITH IN TRADE AREA

STORE HOURS  
9 a.m. til 6 p.m.  
WEEKDAYS  
9 a.m. til 4 p.m.  
SATURDAYS

# RECLINER SALE

## NEW SHIPMENT!!

40 BEAUTIFUL RECLINERS  
TO CHOOSE FROM

## "THE SPOILER"

"OUR BEST SELLING ROCKER-RECLINER"



Recline into today's lifestyle

Comfort is abundant in this generously-proportioned chair. The pillow back features deep button-tufting. Thickly-padded roll arms gently cushion your arms. Pillow seat is soft and deep. Traditional styling.

BEAUTIFUL BROWN  
SADDLE VINYL

**\$289**

RETAIL VALUE \$369<sup>95</sup>

HERCULON VELVET  
IN CAMEL OR BROWN

**\$379**

RETAIL VALUE \$449<sup>95</sup>



## Action RECLINERS BY Lane

**ACTION RECLINERS BY LANE  
OFFER COMFORT, GOOD LOOKS,  
AND TROUBLE-FREE OPERATION.  
SHOP POARCH'S TODAY AND SAVE!**



### No. 1520 "Big Man's Chair"

Big! Space Saving! Luxurious!

The chair you have always wanted. Sink into the comfort of the big, soft, pillow back. Run your hands over the big padded arm rests. The big recliner takes up no more space than a regular chair. Sits only inches from a wall.

BROWN  
SADDLE  
VINYL

**\$266**

RETAIL VALUE  
\$349<sup>95</sup>

RUST OR  
BROWN  
HERCULON

**\$299**

RETAIL VALUE  
\$389<sup>95</sup>



### #1735 Wall Saver®

A generously proportioned traditional classic. Deeply tufted back and thick roll-arms. Needs only a few inches of space from wall to fully recline.

BROWN VINYL

**\$169**

RETAIL  
VALUE  
\$229<sup>95</sup>

CHOOSE FROM  
VINYL OR  
HERCULON

### #1894 Rocker Lounger

Traditional beauty that offers you the comforts of both a recliner and a rocker. Exquisitely tailored with tufted attached-pillow back and full skirt. Large selection of lovely fabrics.

100% ACRILAN VELVET  
BLUE, BROWN, ORANGE

**\$259**

RETAIL VALUE  
\$349<sup>95</sup>



### 1882 Rocker Lounger

Rock and recline in this Colonial masterpiece. Here's true comfort and true value in a chair that is sure to be the most sought after chair in the house. The rugged textured fabric and the wood trim make for a great look too!

100% NYLON VELVET  
RUST OR CINNAMON

**\$339**

RETAIL VALUE \$449<sup>95</sup>

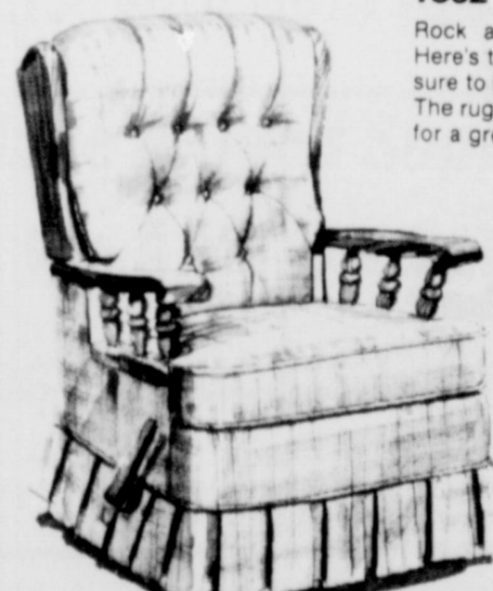

**LAYAWAY NOW FOR MOTHER'S DAY  
MAY 11th**

IF YOU WANT VARIETY WE HAVE IT...

CHARGE IT...USE BANK-AMERICARD

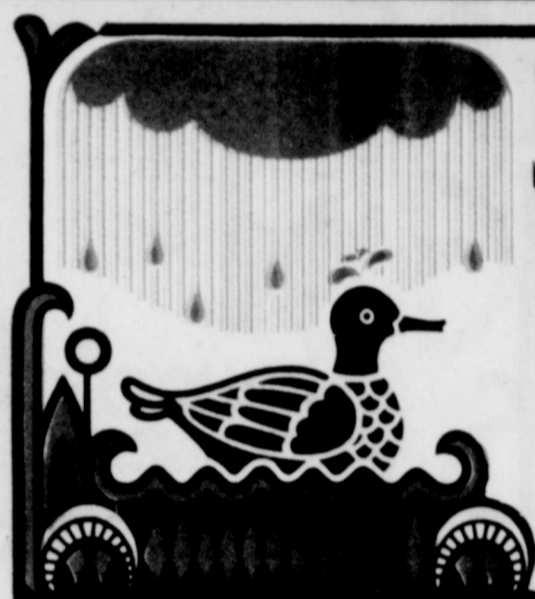

# SHOWERS of SPRING VALUES

SALE  
STARTS  
TODAY



found at  
**PERRYS**

## ASSORTMENT CANVAS-VINYL BAGS

LADIES' HANDBAGS...  
Accessorize your wardrobe with a  
smart new CLUTCH, TOTE or  
SNAP CLOSING! In assorted  
colors.



PERRY'S  
SALE  
PRICE

YOUR  
CHOICE

**397**  
EACH

## ASSORTMENT WALL MIRRORS

3 Styles...  
RECTANGLE 23"x29"  
OVAL Shape 20"x24"  
Long OCTAGON 19"x25"  
Each frame is hand finished in antique gold



PERRY'S  
SALE  
PRICE

**588**  
EACH

3  
STYLES

## LADIES POM POM

White body with  
pastel trim and pom

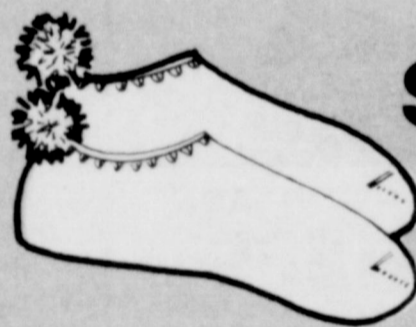

## SNEAKER SOCKS

PERRY'S  
SALE  
PRICE

**77¢**  
PR.

## SIZE 60"x81" 100% DACRON SUPERWIDE TAILORED PANELS

PERMANENT PRESS... Choose from  
assorted colors to match your room decor...  
Wash in lukewarm water with mild soap.

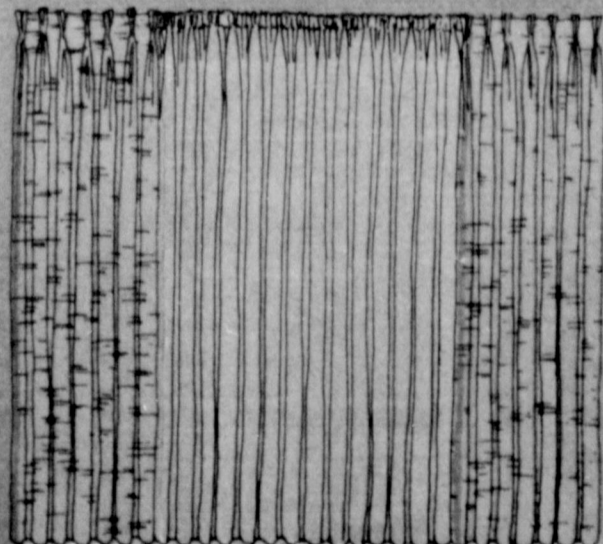

PERRY'S  
SALE  
PRICE

**328**  
EACH

## SIZE 46"x84" FIBERGLASS THERMAL-LINED DRAPERIES

A soft foam lining backing comes in  
assorted solid colors... resists summer  
heat and keeps room warmer in winter...  
lasting beauty for your room!

PERRY'S  
SALE  
PRICE

**588**  
PAIR

**FANTASTICK**  
 TWO HEADS ARE BETTER THAN ONE. THAT'S FANTASTICK™  
 MARKER AND BALL POINT PENS WITH INK REMOVERS.  
 SPECIAL SALE PRICE  
**97¢**

IF YOU WANT VARIETY WE HAVE IT...  
**SHOWERS of SPRING VALUES**  
 found at **PERRYS**

**BATTERIES**  
 EVEREADY BATTERIES IN 2 PKG.  
 SIZE D  
 SIZE C  
**47¢** PKG.

**WEST BEND** 3 1/2-QT. TRIG  
**TEA KETTLE**  
 WITH COPPER BOTTOM  
**647**

13 oz. Beverage Set 15 oz. Cooler Set 13 oz. Goblet Set  
 12 oz. Rock Set  
 9 oz. Juice Set  
**4-PC. CRYSTAL ICE BEVERAGE SETS**  
 Crystal that's as fresh and bright as the first frost.  
 YOUR CHOICE  
**347** SET OF 4

**MEN'S, BOY'S AND JR. MISS PRINTED "T" SHIRTS "BLOOPERS" IRREGULARS**  
 Action Screen prints on cotton & polyester. In bright colors with contrasting rib trim.  
 SIZES S-M-L-XL  
**177** EACH

**EARRINGS**  
 Pierced Earrings Surgical Steel Posts Hypo-Allergenic  
 12kt Gold Filled Posts to choose from Gold & Silver Tone  
 Big assortment to choose from  
**88¢**

**PLASTIC SHOWER CURTAINS AND HOOK SET**  
 72" x 72"  
 Color-Bright solids or prints... soft, pliable plastic, drapes gracefully... 100% vinyl for lots of wear... wipe clean with damp cloth... large size... protects floors and walls... 72" x 72"  
**337** SET

**LADIES' NYLON SATIN BRIEFS**  
 Nylon Satin Briefs with Covered Waist Band and Cotton Liner for Comfort and Personal Protection.  
 SIZES 5 TO 10  
**88¢**

**THE BICYCLE TRIANGLE SCARF**  
 These Scarves give the height needed for a flattering appearance.  
 • PRINTS  
 • SOLIDS  
**97¢** EACH

**PLASTIC ELEGANT HANGERS**  
 COMES IN ASSORTED COLORS  
**12¢** EACH

**CHROMEWARE ASSORTMENT**  
 GIFT  
 • SERVING TRAY  
 • SHELL TRAY  
 • BUTTER DISH  
 YOUR CHOICE  
**588** EACH

**5-PIECE SINK SET PLUS 3-PIECE MIXING BOWL SET**  
 Dish Drainer  
 Drainboard  
 Soap Dish  
 Utensil Holder  
 Sponge Cleaner  
 — ALL FOR —  
**297**

**7-PIECE PORCELAIN COOKWARE SET**  
 SHOP EARLY  
 More than just good looking and good value, RESULTS.  
 Boutique "Mushroom"  
 7 Piece Set  
 1 Qt. Cov'd Sauce Pan  
 2 Qt. Cov'd Sauce Pan  
 5 Qt. Cov'd Dutch Oven  
 10" Open Fry Pan  
**2788** SET

**ASSORTMENT STRAW BREAD BASKETS**  
 4 styles to choose from  
**57¢** EACH

**BAMBOO WASTE BASKETS**  
 10 1/2" tall... 2 styles solid or open weave... Your choice.  
**157** EACH

**157** EACH



# PERRYS

LOOK AT THESE MONEY SAVING SPECIALS-SAVE UP TO 50%

Fabrics not available at all Stores.

**PUFFS FACIAL  
TISSUES  
FLORAL PRINTS**



125  
COUNT

**59¢  
BOX**

**DIAPERS**



24-COUNT  
EXTRA  
ABSORBENT **288**  
BOX

12-COUNT  
TODDLERS **188**  
BOX



**37¢**

## NEW KNITS

for Summer  
Sewing  
**DRESS  
WOVENS**

45" Wide - Dressmaker  
Lengths  
Assorted Blends  
Machine Wash  
Prints & Solids

463  
519 **97¢**  
YD

**TERRY  
BOUCLE' KNIT**

60" Wide - Dressmaker Lengths  
Poly/Cotton Blend  
Machine Wash  
Fashion Solid Colors

#187 **197**  
YD

**INTERLOCK  
KNIT**

60" Wide - Dressmaker Lengths  
100% Polyester  
Assorted Solids & Prints

#101 **97¢**  
YD

**T-SHIRT  
INTERLOCK  
KNIT**

Dressmaker Lengths  
Poly/Cotton Blend  
Machine Wash  
Prints & Solids

#110 **88¢**  
YD

**POLY  
INTERLOCK  
KNIT**

60" Wide  
Machine Wash/Dry  
Beautiful Fashion Colors  
Our Regular \$2.99 yard

#166 **197**  
YD

**PELLON  
INTERFACING**

Light Weight - Sheer Weight  
Fusible - Nonfusible  
Regular to \$1.19

207-208  
243-244 **77¢**  
YD

**FANTASTIC  
BUY!  
BUNCH  
DRIED  
FLOWERS**

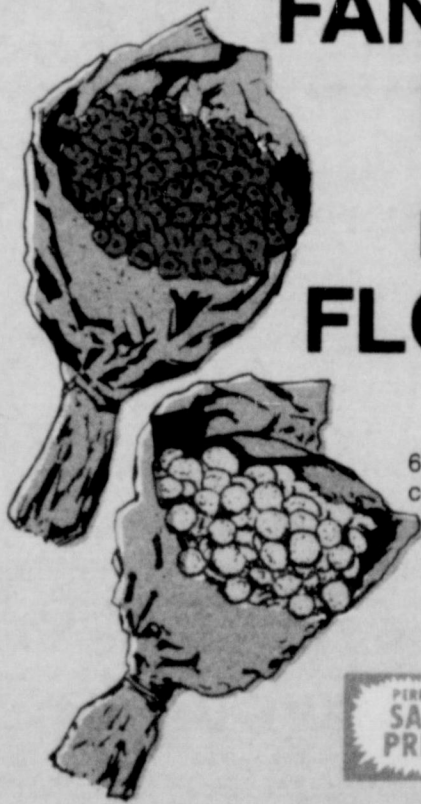

6" to 8" tall... Assortment  
consists of natural and colors  
star, hill and happy flowers

YOUR CHOICE

**47¢**  
BUNCH

**PLASTIC PARSON'S  
TABLE**

• White • Almond • Yellow

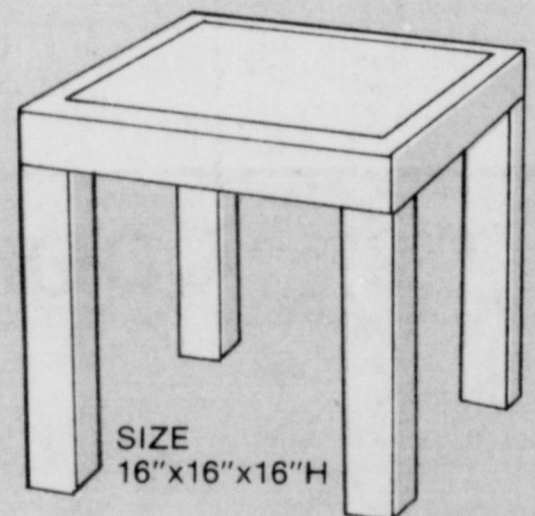

SIZE  
16"x16"x16"H

Easy to assemble... with  
scratch and mar resistant  
texturized finish!

**388**

Supplement to: The Tyler Courier-Times Telegraph • The Gilmer Mirror • Lufkin News • The Pando Watchman • East Texas Light • San Augustine Rambler • San Augustine Tribune • Angleton Times • The Brazosport Facts • Bay City Tribune • El Campo Leader News • The Winkler News • Herald Courier • The Longview Daily News or Longview Morning Journal • The Winters News • The Hearnes Democrat • Alvin Advertiser • Fayette County Record • Breckenridge Banner Press • Burleson County Citizen-Tribune • Sumnerville Tribune • Pictorial Press • Newsweek Examiner • The Orange County Leader • Pampa Record • Vidonian Shopper • The Illustrated Press • Fulk County Enterprise • The Mexico Daily News • The Ennis Daily News • Athens Daily Review • The Daily Progress • The Daily Sentinel • Brown County News • The Citizens Journal • Jefferson Impulse • Wood County Record • The Grand Saline Sun • Edgewood Enterprise • Free Press Goldsboro Times • Liberty Gazette • Livingston News • Martin Democrat • Ft. Stockton Pioneer • Del Rio News-Herald • The Taylor Daily Press • Lockhart Post Register • The Gonzales Inquirer • Tribune Herald • Press Reporter • Mineral Wells Index • Waco Tribune-Herald • Stephenville Daily Empire • The Mid Valley Town Crier • Eastford Telegram • Ranger Times • Cisco Press • Rising Star • Coleman Democrat Voice • Yorkton Herald Times • The Corpus Record • Beeville Bee Progress • Port Lavaca Wave • Gatesville Messenger • Comman Herald • The Citizen • The Newberry • The Childress Chronicle • Lamb County Leader News • Plainville Daily Herald • The Snyder Daily News • Stamford American • Colorado City Record • The Franco Star • Death County Vindicator • Opheim Stockman • Mathis News • Hillburo Reporter • The Loredo Times • Tule Herald • Sutton Enterprise • Sutton-San Patricio County News • Blackenridge American • Bellville Times • Wills Point Chronicle • Teague Chronicle • The Galveston County Advertiser • The Liberty Vindicator • The Highlands Star • Hemisville Item, Inc. • The Comanche Chief • The Community News • Mount Pleasant Daily Tribune • Lynn County News • The Woodlands Sun • Hockley News • Whitney Messenger • The Kansas City Citizen • Hugo Daily News • Aransas Pass Progress • The Ingleside Index • Sentinel • The Shamokin Democrat • Banner Publishing Co. • The Shamokin Texas • Royal County Reporter • The Knox County News • Mulvane Publishing Co. • San Marcos Daily Record • The Devil's River News • The Daily News Telegram • The Lockney Beacon • The Seagrass Enterprise • Bousier Press • The Pittsburg Gazette • Daily Citizen • Lakeville News • The Rockwall Success • The Nixon News, Hockley Free Press Journal • Weather Mass Bluff News, Venable Review • Nixon Drummer • The Woodland Village • The North Harris County News • The Matokoff News