

HOLD ON TO YOUR HAT... IT'S RODEO TIME!

Members of the Fisher County Sheriff's Posse are in the process of preparing for the 16th Annual Amateur Rodeo to be held June 15, 16, and 17.

The Fisher County Rodeo will begin on Thursday with a big downtown parade beginning at 5 p. m. Leading the parade will be the Six White Horses from Hardin-Simmons University in Abilene.

The parade is open to anyone desiring to enter a float of any kind. There will be trophies awarded to the adult riding clubs and a first place trophy to the best Junior Riding Club in the parade. Judging will be according to the American Association of Sheriff Posse and Riding Club standards.

Connie Byrd of Rotan, a student at Hardin-Simmons and member of the Six White Horses team will be participating in the grand entry drill Thursday night.

The rodeo is being produced by Adrian Parker of St. Jo, Texas. Jack Lain of Sweetwater is the rodeo clown.

The 73 Club will sponsor a country-western dance each night at the Community Center. Music to be furnished by J. W. Brewer and his Auctioneers.

The events in this years rodeo include calf roping, double mugging, bare back bronc riding, saddle bronc, open barrel race, jack pot barrel race and bull riding.

There is going to be a special Pony Express race involving several Fisher County Sheriff Posse youth during the three-day rodeo.

Several Fisher County cowboys are scheduled to participate in various events of the rodeo. On Friday, Mike Cade and Tommy Frierson are entered in the bull riding event and on Saturday night Buddy Jones will try his hand at bull riding. In Friday night's bareback bronc event, Frank Garcia and Ronnie Martin are scheduled to ride and on Saturday Larry Gruben and Mike Cade are entered in the event.

Editorial Comment By Kim Pease

Free Ride Over

In the distant future Fisher County residents will be faced with what could prove to be the most important decision they will ever be asked to make, when they vote for or against forming a county hospital district.

We pledged to keep our readers informed on important issues involving the progress of the hospital steering committee, and to date there have been no significant changes in the committee's plan. The next important step comes when the proposal is brought before the Legislature in Austin during the special session. If the members of the Texas House of Representatives and Senate approve the district as submitted, then it will be up to the residents of Fisher County to accept or reject the proposed hospital district. A special election will be called and each resident will be given the opportunity to vote after the district has received approval in Austin.

We attempted to emphasize in our editorial of May 11th that residents would have a vote and we re-emphasize that point today. We understand that there is a group circulating a petition in the east section of Fisher County that is informing potential signers that if the proposal passes the legislature, there will not be a vote by the people. This is absolutely untrue. There will never be a hospital district in Fisher County if the people don't vote to have one established.

We, in Fisher County, need to begin to realize that "the free ride is over", if we don't pay hospital district taxes for a hospital in Fisher County, we'll eventually pay them somewhere. Hamlin is beginning to move toward establishing a hospital district, and they would just love to take in the eastern portion of Fisher County. Sweetwater is not beyond creating a hospital district and swallowing up as much of Fisher County as they want. They have the vote in Sweetwater to do just about what they please.

If we are going to have to pay taxes in the future, why not pay them in Fisher County for a county hospital?

Park Among Top At 4-H Roundup

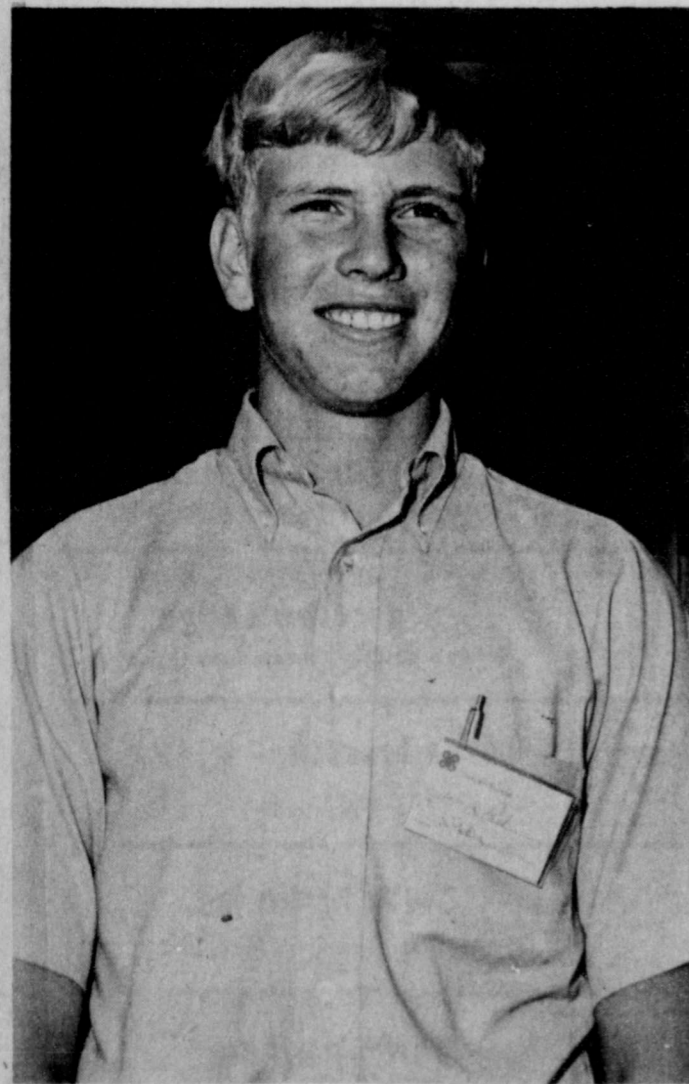

James Park

Fisher County was represented by the Soil Evaluation, Livestock Judging and Public Speaking Teams at 4-H Round-Up at College Station, June 6-8.

The Livestock team composed of Stuart Carey, Terry Posey, Mark Guelker and Glen Wilfong placed 10th. The Soil Evaluation team composed of James and Gary Park, Robert Callan and Dale Wilfong placed 11th. James Park was the 10th high individual in the contest and received a watch.

Audrey Carey represented the county in Girls Public Speaking. The Livestock Team entered the Texas Jr. Hereford Field Day in Bryan June 9. The contest was held at the Walter Britten Ranch. The team placed 8th and Stuart Carey was the 4th high individual in the contest.

Richard Spencer and Alice Ballenger, County Extension Agents, accompanied the teams to College Station.

Red Cross In Need Of Money For Victims

John Jackson, who heads up the Fisher County Red Cross Chapter, received a letter from William Schweitzer, Red Cross Division Manager concerning the recent flash flood in Rapid City, S. D.

Red Cross disaster funds have been wiped out by the recent southwest Texas floods. Kentucky floods, Buffalo Creek and West Virginia floods. The West Texas Division of the American National Red Cross has set a quota of \$80,000 for Fisher County. Anyone interested in making a contribution to the Red Cross can do so by contacting John Jackson.

Homemaking Workshop

A workshop will be conducted by Carolyn Simmons, Roby High School Homemaking Instructor for Interested Students, parents, and community members. The sessions will be each evening from 5 to 7 p. m. June 19, 20, and 21.

Purpose of the workshop is to help coordinate classroom experiences with home and community needs.

Anyone interested in attending the workshop is urged to attend, and if possible please call Mrs. Simmons at the Roby High School office, 776-2481.

McMurry Honor

Maxine Phillips, daughter of Mr. and Mrs. Robert Phillips, of Rotan, and Rhoda Jones, daughter of Mrs. Sue Kelley, also of Rotan, were listed on the Honor Roll for the spring semester at McMurry College, Abilene.

The Honor Roll is made up of those students who achieve a grade point average of 3.5 or above, while carrying a minimum of 12 semester hours.

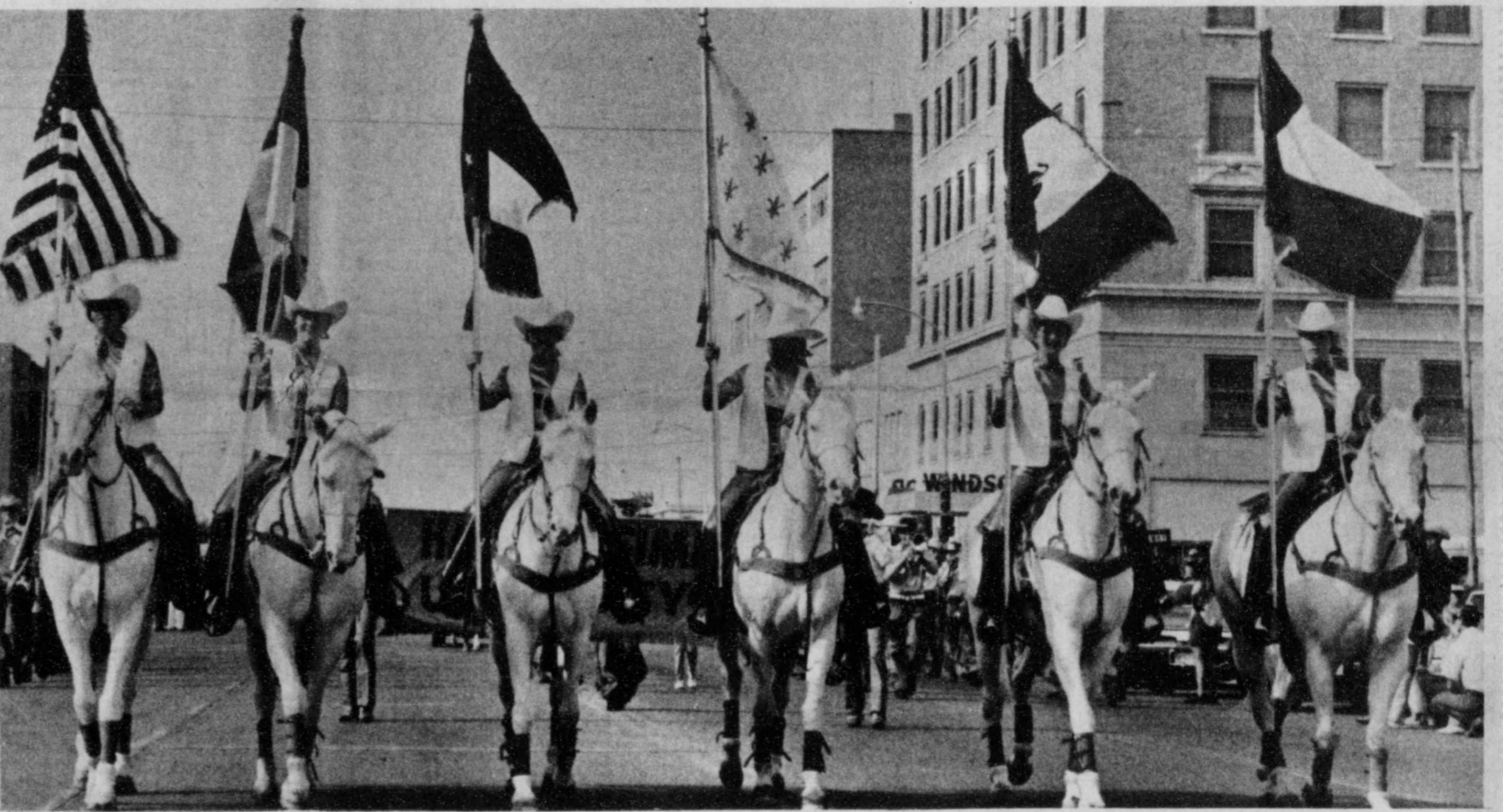

SIX WHITE HORSES: The Six White Horses from Hardin-Simmons University, Abilene, will be featured in the Fisher County Sheriff's Posse Rodeo Parade Thursday. Riders are left to right, Nema Westmoland, Connie Byrd, Penny Teiman, Cindy Wylie, Marsha Webb and Nan Alexander.

Price To Head Roby Lion's Club

The Roby Lions Club will hold an installation service for new Lion officers on June 29th, according to J. T. Palmer, president.

Jimmy Price was elected as the new Roby Lions Club President. Vice Presidents include: 1st, Leon Donham; 2nd, Jimmy Hayes and 3rd, Terry Mauldin.

The new secretary-treasurer for 1972-73 will be Don Waddell. Lynn Randolph will serve as the Tail Twister and Zanna Anderson will serve as assistant Tail Twister.

The newly elected Lion Tamer is M. A. Hughes and Ralph Ammons will be the Song Leader.

Susan Knox will be the Roby Lions Sweetheart.

Four directors were elected by the membership. One-year director posts go to Lynn Randolph and Oddis Brown; serving as 2-year directors are Cecil King and Ed Deaton.

Mrs. R. D. Sartor, Rotan, spent last weekend in Lubbock visiting her sister and brother-in-law, Mr. and Mrs. C. F. Addington.

Louie Don, grandson of Mr. and Mrs. L. D. Brigs of Rotan, is spending a few weeks with his grandmother and granddad.

Roby School Board Votes To Join Regional

The Roby School Board met Monday, June 12, at 8 p. m., with the president, Jerry Hoodenpyle, presiding. The minutes and bills were accepted and approved.

The first line of business was the purchase of a pick-up for the F&M Chevrolet. Kyle Moore made the motion the pick-up be purchased and Ben Neepser seconded the motion, and this passed.

There was discussion on the insurance collected for the repair of roofing. Hub Bennett made the motion that they accept

the bid of the Barr Roofing Co. of Abilene to repair the auditorium, gym, and the grade school. The motion was seconded by Kyle Moore and passed.

There was discussion on the positions of the school in the areas of coach, band director, principal, science teacher and homemaking teacher. Bus maintenance is to be discussed and decided next month.

The motion was made by Kyle Moore to advertise for bids to be accepted on the 1961 International, 2-seater pickup.

Ben Neepser seconded this motion and it was passed. The motion was made by Ben Neepser to enter into agreement with the Regional Service Center for their services during the 1972-73 school year. This was seconded by Kyle Moore and passed. The meeting was then adjourned.

Mrs. Lewis Gregory of Dallas visited her mother, Mrs. E. G. Baker and others in Rotan last week and her brother and family, Mr. and Mrs. Jim Baker of Jayton.



CHAMBER OF COMMERCE MEMBERS: Present at Tuesday morning meeting were, left to right, Garvis Hinson, Lester Sessil, new president Cecil Champion, and Yoke Fleming.

Cecil Champion Is C of C President

Four new Rotan Chamber of Commerce Directors assumed duties at the regular monthly Chamber meeting last Thursday morning.

Those elected by the Chamber members to serve as directors include: Ray Womack, Lester Sessil, Yoke Fleming, and Garvis Hinson. Billy Green and Rodney Tankersley were the other two seeking director positions.

The four new directors will be serving with Mrs. Dono Darden, Larry Landes and Cecil Champion.

Luther Summers, outgoing C of C President, opened the business meeting by urging the new directors to give special consideration to keeping the Christmas Lighting Program going.

The directors present, elected Cecil Champion as President of the Rotan Chamber of Commerce for the 1972-73 year. Larry Landes was elected as Secretary-Treasurer.

Those directors going off the board this year include: Bill Day, Calvin Crow, Luther Summers and Arvin White.

Recent guests in the home of Mrs. C. E. Leon, Rotan, were Mrs. J. E. Geer of Rule, Mr. and Mrs. C. D. Leon of Santa Fe, N. M., and Mrs. Spence Blackburn and son, the Rev. Bill Blackburn of San Angelo.

Calvin Crow, Rotan, is to have major surgery in Dallas, June 20, at the Veterans Hospital.

All-America Game Tickets Are Available

Those interested in attending the 12th annual All-American Game in Lubbock on June 24, can obtain tickets from any Rotan Lion Club Member, announced Dr. Maurice Callan, Rotan Lions Club President.

The coaches All-American Game will be played at Lubbock in ones Stadium and the coaches will be Paul "Bear" Bryant, Alabama, for the east, and Chuck Fairbanks, Oklahoma, for the west.

Some of the top players in the country will be participating in this game. Such names as Johnny Musse, Alabama; Jeff Kinney, Nebraska; Jack Mildren, Oklahoma; Larry Molinare, Texas Tech; Jerry Tagge, Nebraska; and Gary Hammond, SMU.

National Gyp

The Board of Directors of National Gypsum Company has declared a regular quarterly dividend of \$1.12-1/2 per share on its preferred stock payable September 1, 1972 to holders of record August 11, 1972.

Miss Emily Garrett, Rotan, visited her niece, Mrs. Winnie Henderson in Post last weekend.

Mr. and Mrs. Jim Weathers and family of Odessa visited Mr. and Mrs. Ray Ashton in Rotan last week. Mr. and Mrs. Ashton visited their son Bill and family in Abilene last weekend.

THE VOICE OF FISHER COUNTY
THE ROBY STAR RECORD
AND
THE ROTAN ADVANCE

The Supreme Test of Good Journalism is the Measure of its Public Service.
Walter Williams,

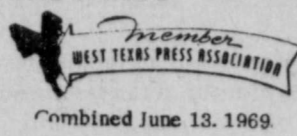

KIM PEASE - - - EDITOR & PUBLISHER
JANECE PEASE - - ASSOCIATE EDITOR
H. C. Shelton
Publisher 1906-1965
E. H. Shelton
Publisher 1965-1970

Published Thursdays except last Thursday in the year

Any erroneous reflection upon the Character, Standing, or Reputation of any Person, Firm or Corporation which may appear in the columns of this newspaper will be gladly corrected upon due notice given to the publisher at the office at 113 Snyder Ave., Rotan, Texas. The publisher reserves the right to accept or reject any article or manuscript submitted for publication.

SUBSCRIPTION RATE

\$5.00 In Fisher County
\$5.50 Outside County
\$3.00 College Student (9 mos.)

Entered as second class matter at the Post Office in Rotan, Texas under the act of Congress of March 3, 1879. Second Class postage paid at Rotan, Texas 79546.

Kim's Korner

By Kim Pease



LAST CALL: Rotan Ag Teacher Ronnie Tichelman asked that we issue a last call for names to be placed on the 1972-73 FFA Birthday calendar. Birthdays will be listed for 25¢ each and anyone interested can contact Clay Helms at 735-2945 or Bruce Jones at 735-3474. Final cut-off date is Saturday night, June 17th.

ROBY LION SPEAKER: Rotan banker Wayne Harris will be the guest speaker at the noon Roby Lions Club meeting on Thursday June 15. Harris is closely involved with the committee seeking to assure Fisher County residents of adequate medical facilities in the future and is expected to speak on that subject.

CANCELLATION THREAT: My good friend Glen Copeland threatened to cancel his subscription if I didn't get on the ball and start pecking out this "off the wall" column again. Rather than lose a subscriber, I'd do almost anything short of murder and treason.

THE BIG MAYBE: My young son John, age 3, found a pair of scissors the other day and decided to test his natural ability at barbering. He took a few choice chunks of golden locks from the side of his head. When I finally noticed his "butcher job", I sat him down and began a serious father-son talk. "John", I said, "did you cut your hair?" In a very serious tone and in a quiet voice he responded by saying "maybe I did, and maybe I didn't". Well, he did it again, outsmarted old Dad. After his non-committal remark I flashed a broad smile and marveled at how he veered out of a tight corner. He wanted to feel me out to see how I liked his "butcher job" before he gave me a straight answer. My Dad asked me the same question about 26 years ago and as best I remember, I went to bed hungry that night.

OLD PICTURES: We have had a few comments recently on old pictures. We will be glad to run them in the paper as space permits. If you have an old picture that you would like to share with Fisher County, drop it by the office. We will return it to you unharmed.

GOOD NEWS: We understand Mrs. Jack McClure is doing much better after her surgery in Abilene recently. Hope she is able to come home soon and return to her normal routine.

UNCLAIMED TIRES: Police Chief Kenneth Hardin asked that we call your attention to some unclaimed tires that were taken off cotton trailers at the Farmers Gin lot. If you have a trailer at the lot, check and see if any tires are missing. Hardin has 7 unclaimed tires and rims.

INCOMPLETE STORY: A few weeks back we reported in a story that Candy White Dycus had graduated from ACC. What we failed to mention was that she did it with honors. Congratulations.

COTTON'S NEW HOME: Cotton Clawson has moved across the street from the Advance Office. The former location of Cotton's garage was north of town. We wish him luck at his new location.

THANKS TO MERCHANTS: Donna Gruben sold the Rodeo page advertising in this weeks paper. She did a fine job and a big thanks to the merchants for helping her. We hope the readers notice those that support the Rodeo Page and thank them for doing so. The merchants that advertise in this paper are the ones that make it possible for us to publish each week.

VACATION: If you're planning a vacation trip this summer, why not take a picture and let us run a story. If you tell us, we'll tell Fisher County.

RODEO TIME: Don't forget the Fisher County Sheriff's Posse Rodeo this weekend. The big event will kick off Thursday at 5:00 with a downtown parade led by Six White Horses.

REMINDER: The Newspaper office in Rotan has a full line of office supplies. We invite you to stop in and see our stock.

WINNER: Leandro Ramon of Roby was winner of the La-Z-Boy Recliner given away by Landes Furniture. The drawing was held last Saturday at 4 p. m.

BRAIN BUSTER: Figure this one out. Drop us a post card and let us know how long it took you to get your answer. "A man travels a total of 4.1 miles each day to and from work. The travelling consumes 73 minutes each day. How many hours would he save in 120 working days if he moved to another residence so that he would travel only 1.7 miles each day in travel?"

THOUGHT FOR THE WEEK: Give someone a piece of your heart instead of your mind.



ROBY FIREHALL, Above is a picture of the newly re-modeled Fire Hall Building in Roby. All the work was done by volunteer firemen to include completely re-doing the inside, installing a new ceiling, air conditioning system, new rest rooms, and a new floor. The new building is going to be used as a meeting place for the firemen, a community building, and a site for family reunions. Pictured are Kidd Waddell, Pete Driver, Ruben Rodriguez, Howard Fought, J. M. Whitfill and Wayne Pursley. Plans are to remodel the exterior in the near future.

Mrs H.C. Shelton Gets OES 50th

Rotan Chapter #52 OES held open installation June 6th in Masonic Hall. Regina McArthur registered guests. Bible was presented by Neal Baker, Square and Compass by Martha Hargrove. Highlight of the evening was Presentation of 50 year certificate and pen to Mrs. H.C. Shelton. Mrs. Shelton was escorted to the fast by her son and his wife, Mr. and Mrs. Hooper Shelton. Lorena Darded presented the 50-year certificate from Grand Chapter of Texas O. E. S. and a 50-year pen from Rotan Chapter #52. Bernice Hargrove was installing Officer assisted by Joyce Noles, Deputy Grand Matron, District 2, Section 7. Installing Marshall, Helen Thorburg, Roby Chapter #25, installing Chaplain,

Darthulia Hale, installing Organist; and Evelyn Hamm, installing Secretary Pro-tem. Those installed were Lorena Darden, Worthy Matron; John K. Myers, Worthy Patron; R. O. Allen, Associate Patron; Mattie Key, Secretary; Bertha Allen, Treasurer; Janie Phillips, Conductress; Mina Huckaby, Chaplain; Bettie Hargrove, Marshall; Bessie Louise Miers, Organist; Juanita Forest, Adah; Bessie Shipp; Esther; Stella Senn; Martha; Alvis McArthur, Electa; Beatrice Myers, Warden. Special music was presented by Steve Baker and Lou McCombs. Past matrons and patrons jewels were presented by Patsy Kelley. Refreshments were served in the dining hall following the program.



How BEAUTIFUL!
THE ROTAN HATAHOE NOW
HAS REFRIGERATED AIR.

Hatahoe Drive In

<p>CHURCH OF CHRIST Rotan, Texas Jerry Berry, Minister Bible Study - 9:45 a. m. Worship - 10:30</p>	<p>FIRST BAPTIST CHURCH Rotan, Texas Rev. Fred Thomas, Pastor Sunday School - 9:45 a. m. Worship - 10:55 a. m.</p>	<p>METHODIST CHURCH Longworth, Texas Newton Daniel, Pastor Sunday School - 10:00 a. m. Worship - 11:00 a. m.</p>	<p>CALVARY BAPTIST CHURCH Rotan, Texas Rev. Jack DeWitt, Pastor Sunday School - 10:00 a. m. Worship - 11:00 a. m.</p>	<p>ROBY CHURCH OF CHRIST Roby, Texas Wardell Halliburton, Minister Bible Class - 10:00 a. m. Worship - 11:00 a. m.</p>	<p>PRIMITIVE BAPTIST CHURCH Roby, Texas Elder J. R. Knight Song Service - 10 a. m. - 4th Sun. Worship - 11:00 a. m. - 4th Sun.</p>														
<p>FIRST UNITED METHODIST Rotan, Texas Albert W. Cooper, Pastor Sunday School - 9:30 a. m. Worship - 10:30 a. m.</p>	<p>HONEYMOON</p> <p>The wedding bells rang, the bride was radiant, the groom's mother cried, just a little, and the maid of honor caught the bouquet. It was a perfect wedding, and the honeymoon has been ideal. Tomorrow, this young couple will be going home to begin a new way of life. In it, reality will be combined with romance. There will be the blending of two temperaments under a single roof. There will be all the frustrations of daily living, and the pain as well as the pleasure that comes with just being alive. How will they adjust? That depends on the basics that were taught to them years ago, in their own homes—and in church.</p> <p>Copyright 1972 Keister Advertising Service, Inc., Strasburg, Virginia. Scriptures selected by the American Bible Society.</p> <table border="1"> <tr> <td>Sunday</td> <td>Monday</td> <td>Tuesday</td> <td>Wednesday</td> <td>Thursday</td> <td>Friday</td> <td>Saturday</td> </tr> <tr> <td>Ecclesiastes 6:1-12</td> <td>Job 14:1-9</td> <td>Psalms 14:1-7</td> <td>Ecclesiastes 7:1-6</td> <td>Ecclesiastes 12:8-14</td> <td>Lamentations 3:1-18</td> <td>Romans 1:17-23</td> </tr> </table>			Sunday	Monday	Tuesday	Wednesday	Thursday	Friday	Saturday	Ecclesiastes 6:1-12	Job 14:1-9	Psalms 14:1-7	Ecclesiastes 7:1-6	Ecclesiastes 12:8-14	Lamentations 3:1-18	Romans 1:17-23	<p>FIRST UNITED METHODIST McCauley, Texas Vernon Mayfield, Pastor Sunday School - 10:45 a. m. Worship - 9:45 a. m.</p>	<p>McCAULLEY BAPTIST McCauley, Texas Virgil Smith, Pastor Sunday School - 10:00 a. m. Worship - 11:00 a. m.</p>
Sunday				Monday	Tuesday	Wednesday	Thursday	Friday	Saturday										
Ecclesiastes 6:1-12	Job 14:1-9	Psalms 14:1-7	Ecclesiastes 7:1-6	Ecclesiastes 12:8-14	Lamentations 3:1-18	Romans 1:17-23													
<p>CHURCH OF NAZARENE Rotan, Texas H. D. Williams, Pastor Sunday School - 9:45 a. m. Worship - 10:40 a. m.</p>	<p>HIGHLAND HOME BAPTIST Rotan, Texas John Barnes, Pastor Sunday School - 10:00 a. m. Worship - 11:00 a. m.</p>	<p>SYLVESTER BAPTIST CHURCH Sylvester, Texas Sunday School - 10:00 a. m. Worship - 11:00 a. m. Sunday Night - 7:00 p. m.</p>	<p>FIRST UNITED METHODIST Sylvester, Texas Morning Worship - 9:45 a. m. Sunday School - 10:30 a. m. Monthly Prayer Meeting</p>	<p>ST. JOSEPH'S CATHOLIC Rotan, Texas John Hoorman Mass - Saturday evening 7:30 Mass - Sunday 9:00 a. m.</p>	<p>FIRST BAPTIST CHURCH Roby, Texas Rev. Charles Whitlock, Pastor Sunday School - 10:00 a. m. Worship - 11:00 a. m.</p>														
<p>EMMANUEL BAPTIST CHURCH Rotan, Texas Sunday School - 10:00 a. m. Worship - 11:00 a. m.</p>	<p>LITTLE ZION BAPTIST Rotan, Texas Rev. W. B. Johnson, Pastor Sunday School - 9:45 a. m. Worship - 11:00 a. m.</p>	<p>ROTAN FORTSQUARE CHURCH Eighth and Genevieve John Waldren, Pastor Sunday School - 10:00 a. m. Worship - 11:00 a. m.</p>	<p>EL PASO BAPTIST CHURCH South of Roby F. E. Healer, Pastor Sunday School - 10:00 a. m. Worship - 11:00 a. m.</p>	<p>HOBBS BAPTIST CHURCH Hobbs Community J. H. Skiles, Pastor Sunday School - 10:00 a. m. Worship - 11:00 a. m.</p>	<p>SARDIS BAPTIST CHURCH 9 miles SW of Rotan Rev. Bob Cameron, Pastor Sunday School - 10:00 a. m. Worship - 11:00 a. m.</p>														
<p>WEATHERS BEE FUNERAL HOME 735-2255</p>	<p>CENTRAL LUMBER & SUPPLY "One Call For All"</p>	<p>MARTINEZ DAIRY Milk Keeps You Slim & Trim</p>	<p>ROBY INS. AGENCY 776-2361</p>	<p>FIRST UNITED METHODIST Roby, Texas Rev. S. Homer Salley, Pastor Sunday School - 10:00 a. m. Worship - 11:00 a. m.</p>	<p>CROSS ROADS BAPTIST 6 miles SW of Rotan Rev. Ross Anderson, Pastor Sunday School - 10:00 a. m. Worship - 11:00 a. m.</p>														
<p>H.L. Davis & Co. "The Friendly Store"</p>	<p>ROBIE COTTON OIL MILL 400 S. Cleveland - 735-2271</p>	<p>CRISTVIEW LODGE "Rotan's Newest Convalescent Home"</p>	<p>CHURCH OF CHRIST Rotan Latin American Bible Class - 10:00 a. m. Worship - 11:00 a. m.</p>	<p>NOLES DRUG ROBY 776-2431 - Roby</p>	<p>FARM TRACTOR & SERVICE, INC. Your JOHN DEERE Dealer</p>	<p>FISHER COUNTY NURSING HOME 735-3291</p>	<p>ROBIE INSURANCE AGENCY JOE D. BURK - Agent</p>												
<p>ROBIE PAINT & BODY 735-3441 - Rotan</p>	<p>CLINIC PHARMACY Complete Prescription Service</p>	<p>BILLY HENDERSON</p>	<p>ROBY HYDRO INC. Snyder Highway - 776-2240</p>	<p>MIDWEST ELECTRIC ROBY "Owned by Those We Serve"</p>	<p>FIRST NATIONAL BANK OF ROTAN Established in 1907</p>	<p>BILL & GENE T.V. Your Hometown Zenith Dealer</p>	<p>BART STRAYHORN 735-2231</p>												
<p>ROBIE DEPT. STORE 210 W. Snyder - Rotan</p>	<p>ATWELL CLEANERS Suits Made to Order</p>	<p>HATAHOE DRIVE INN Home of Super-Size Hamburgers</p>	<p>LANDES FURNITURE 735-3171</p>	<p>HOME LUMBER CO. RCA - G. E. - COLORIZER PAINTS</p>	<p>CITIZENS STATE BANK Member F. D. I. C.</p>	<p>ROTANA RESTAURANT Steaks - Mexican Food - Sea Food</p>	<p>CALVIN'S GROCERY & MARKET 735-3112</p>												
<p>SWEETWATER PROD. CREDIT Farm and Ranch Loans</p>	<p>FISHER CO. FARM BUREAU 735-3491</p>	<p>ROTANA RESTAURANT Steaks - Mexican Food - Sea Food</p>	<p>FARMERS UNION COOP. GIN 776-2237</p>																

Rotan Board Hires Floyd Garcia Jr As New Teacher

The members of the Rotan Independent School Board accepted the resignation of Mrs. Ralph South with regret, and voted to hire Floyd Garcia, Jr. as the new high school Spanish teacher at their regular monthly meeting Monday night.

Mrs. South has been teaching for a total of 23 years. She was with the Abilene Independent School system for 10 years prior to coming to Rotan in the 1961-62 school year.

Floyd Garcia, Jr., a graduate of Rotan High School and Hardin-Simmons, will be replacing Miss Josie Baird as the Spanish teacher. He taught last year in the Loraine Independent School District.

Dwight Nowlin entertained a motion that was seconded by Bobby Gruben to approve the minutes of the May meeting.

Dr. Jerry Marshall and Bobby Smith made and seconded a motion, respectively, to pay the bills for May.

Mr. K. C. McCasland, Superintendent, reported to the board the final average daily attendance for the 1971-72 school year. The figure reported was 685.05 students which is down from 711 for the 1970-71 year, because of the reduction, one less teacher will be on the staff next year.

In the next item of business, the board voted to lease to Burl

Acteen Camp Registration Begins Monday

Registration will begin at 2:00 p. m. Monday, June 19, for the Acteen Camp to be held at Lueders Baptist Encampment. The camp will continue through Thursday noon, June 22.

Girls included in the camp will be from six associations: Callahan, Cisco, Sweetwater, Haskell-Knox, West Central and Abilene. Cost will be \$12.00 per person.

Rev. Buddy Sipe of Sweetwater will be Camp Pastor. Bible Study leaders are Rev. Wayne Oglesby, Rev. H. B. Terry and Rev. Harold Scarborough. Seminar Leaders are Mrs. Riley Fugitt, Mrs. Sue Gauthier, Mrs. Carolyn Sipe. Camp Director is Miss Lynn Oglesby of Tuscola.

Using the theme "Acteen's Aware", Mrs. Oglesby has planned a schedule of worship, Bible Study and recreation.

Four From County On Cisco Roll

Four Cisco Junior College students from Fisher County have been named to the Dean's List for the recently concluded spring semester of 1972.

The 4 students on the Dean's List, with a 2.5 or better grade point average in a 3-point system are: Deborah Smith and Bret Clements of Rotan, and David Hill of Sylvester.

Martin one-half acre of land for a three year period. The lease was set at \$10.00 per year and the land is the former old Pleasant Valley School site. Bobby Smith made the motion and Dwight Nowlin cast a second.

Dr. Jerry Marshall made a motion, seconded by Bobby Gruben to submit the final application to the Texas Education Foundation on the CTU's for the 1971-72 year.



Randy Etheredge-High Pointer

Twenty-Three 4-Hers Make District Cut

As a result of the last three Fisher County 4-H Horse Shows the following 4-H Horsemen qualified for district competition.

First, Randy Etheredge, with 65 points; 2, Craig Diddle, 43 points; 3, Dan Burk, 34 points; 4, Janet Callan, 34 points; 5, Melody Walker, 33; 6, Kathy McCombs, 31; 7, Terry Posey, 24

points; 8, Vick Burk, 23; 9, Brad Stuart, 22; 10, Kay Vaughn, 19; 11, David Posey, 18; 12, Timmy Morton, 16; 14, David Gaona, 15; 15, Genia Terry, 14; 16, Kim Ratliff, 11; 17, Jackie Shipp, 9; 18, Penny Coker, 8; 19, Danny Terry, 7; 20, Tana Kohout, 7; 21, Judy Wright, 6; 22, Britt Stuart, 6; Carol Byrd, 6; and Tina McCombs, 5.

Rotan Baptist Youth To Tell Of Glorietta

Sunday night, June 18, at 7:00 the boys and girls that went to Glorietta will present the service at First Baptist Church, Rotan. The youth will tell of their impressions and experiences at Glorietta.

The purpose of the week at Glorietta was for the young people to search themselves under the inspiration of Glorietta and thousands of other young people. They came to a greater understanding of their individual relationship to Christ and to one another. From this trip they gained a new spiritual development in Christ.

The public is invited to attend this service and hear these young people tell about the trip and the things that happened to them.

Mrs. Joe Long of Roby is confined to Scott and White Hospital in Temple but is reported to be much improved. She is out of intensive care and her room number is 735, if you wish to send a card.

Mrs. Hooper Shelton, Rotan, received word here Saturday of the death of her brother, Leslie Vice Cartwright, 79, of Glendale, Calif. Funeral services were held Monday at 12 o'clock in Glendale.

Flash-Bits from Fisher County Nursing Home

If well we are all feeling better after the nice showers Sunday afternoon.

We are very happy to welcome three new patients, who have come this past week to make their homes with us. They are Bill Bacot, Margie Shelley and Hollis Henry.

Mr. Cobb celebrated his 87th birthday Friday by enjoying a fish fry in his honor at the home of his daughter, Mrs. Larry Weatherman. We wish him many happy returns of the day.

Mr. and Mrs. C. W. Whitfield of Ft. Worth visited his mother Mrs. Lillie Whitfield this week. Visiting with Mrs. Shelton were Mr. and Mrs. Dub Permenter of Mississippi and Mrs. Willa McWhirter of Roby. Mr. and Mrs. Byron Shelley and daughter of Abilene visited Mrs. Shelley, Rev. and Mrs. W. M. Bozeman from Stamford and Mildred Bland of Lueders visited Mable Reese. Byron and Sue Turt of Houston visited their great-grandmother Mrs. Nannie Williamson and also Mrs. Reese.

Among ours out in town for church services Sunday were J. T. Holder and Mable Reese to the Church of Christ, Phonia Taggart to First Baptist and Mrs. Hardy to Calvary Baptist.

We are all looking forward to seeing the parade this week. Don't forget us, Sheriff's posse. We are very happy to have Mr. Early home from the hospital. He seems to be doing fine. See you again next edition.

Recital

Mrs. Ina Harris will present her students in a recital Friday, June 16, at 8 p. m. at the First Methodist Church, Rotan. The public is invited.

During the month of June we will feature Six Flags tickets for \$4.19 with each \$5.00 purchase.

WELCOME RODEO FANS

GAUDY'S FROZAN 3 FOR 1.00 SPECIAL

CHUCK ROAST 79¢ LB.

GOOCH BACON 75¢ LB.

MRS. BAIRD'S DINNER ROLLS 30¢ PKG

Kraft 18oz. 43¢

BAR-B-QUE SAUCE 43¢

GROUND MEAT 3 LBS. FOR \$1.00

100 COUNT LIPTON TEA BAGS \$1.25

AMERICAN BEAUTY (1lb) INST. POTATOES 45¢

WATSON LARGE EGGS 39¢ DOZ.

MAN SIZE WAX PAPER Roll 35¢

GOOCH 12oz. FRANKS 63¢

CHUCK STEAK 79¢ LB.

LEAN BEEF RIBS 49¢ LB.

GOOCH 12oz. BAG SALAMI 79¢

10 LBS ICE CREAM SALT 39¢

1/2 GAL STA Puff 85¢

32oz. CRYSTAL WHITE LIQUID FOR DISHES 69¢

14oz. COMET CLEANER 17¢

NABISCO KORIKERS for DIPS 35¢ Box

GREEN CABBAGE 10¢ LB

YELLOW SQUASH 15¢ LB

CORN (EAR) 9¢

CELLO RADISHES 2 PKG 25¢

GREEN ONIONS 10¢ LB.

DELICIOUS APPLES 29¢ LB.

WATCH FOR 6 FLAGS TICKET PROMOTION

Prices Good JUNE 15 THRU JUNE 21

Quantity Rights Reserved

735-2266 OR 735-2267 for DELIVERY

DOUBLE S+H STAMPS ON TUESDAY AND WEDNESDAY EXCLUDING CIGARETTES WITH 25¢ PURCHASE

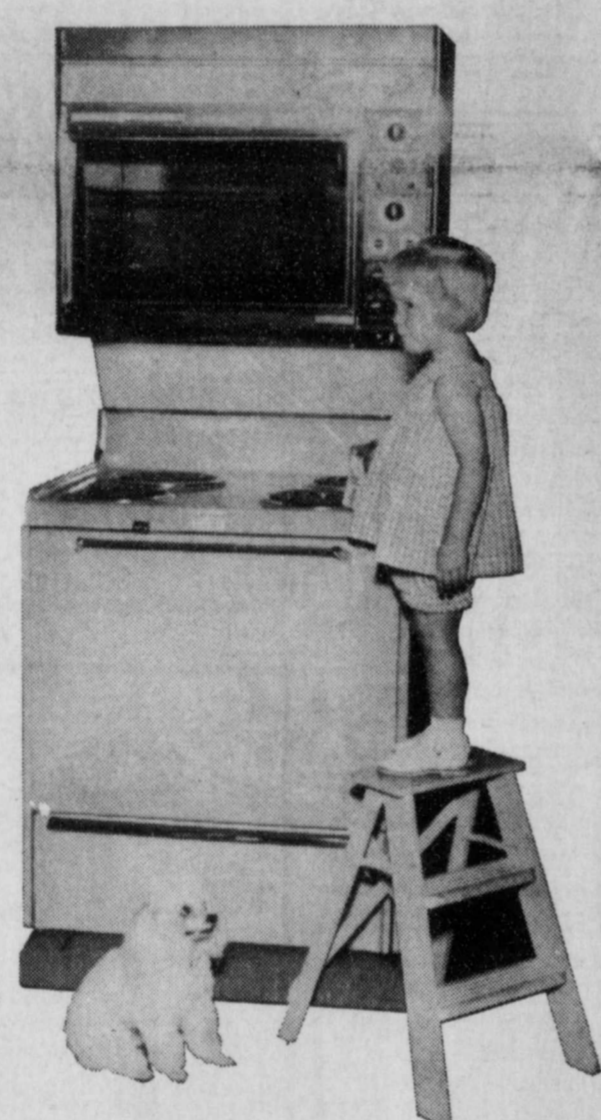

Hungry mouths to feed? Well for goodness sake, buy an electric range!

COOKS GOOD... COOKS CLEAN... COOKS COOL... BUY IT FROM YOUR ELECTRIC APPLIANCE DEALER

FREE WIRING BONUS Normal FREE 220 volt wiring—in a permanently constructed residence served by WTU—for a new Electric Range, Dryer, Water Heater (40 gal. or larger) or a Room Air-Conditioner (1 hp or larger) purchased from a local dealer. Ask for details.

Live the carefree way with Famous Frigidaire Electric Appliances. See them at WTU

West Texas Utilities Company

Start saving now for next Christmas.

Citizens State Bank Roby, Texas

Funeral Services

Mrs J.W. House

Mrs. J. W. House Sr., 96, died in the Rice Springs Rest Home in Haskell at 10:30 p. m. Wednesday, June 7, following a long illness.

Funeral was held at 10:30 a. m. Friday at the First Baptist Church in Rotan with Rev. Ross Anderson, pastor of Cross Roads Baptist Church in Rotan officiating, assisted by George McBeth, a Baptist layman.

Burial was in Dowell Cemetery under direction of Weatherbee Funeral Home.

Born Aug. 5, 1975, in Hill County, she was the former Mary Theresa Maben. She moved to

Rotan at age 14 and married J. W. House Sr. in 1896. He died in 1948. She was an early day schoolteacher in the area and a member of the Baptist Church.

Survivors are five sons, Tom and Bill of Rotan, J. W. Jr. of Weatherford, Roland and C. G. both of San Antonio; three daughters, Mrs. Gordon King of Glorieta, N. M., Mrs. T. J. Brown of Delano, Calif., and Mrs. F. W. Martin of Haskell; one brother, Charles Maben of Merced, Calif.; 1 sister, Mrs. Parker Fisher of Dallas; 10 grandchildren and 11 great grandchildren.

Mrs Walter Wright

Mrs. Walter F. Wright, 95, former Anson resident died at the Williamsburg Nursing Home in Abilene Sunday at 10:30 p. m. after a lengthy illness.

Funeral was held at 3:00 p. m. Tuesday in the Lawrence Funeral Home Chapel with the Rev. Don W. Vaughn, pastor of the First Unitarian Church in Wichita, Kan., officiating.

Burial was in Mount Hope Cemetery with Lawrence Funeral Home in charge.

Born Pauline K. Jones in Waynesville, N. C. Oct. 18, 1876, she moved to Williamson County

Tex., with her parents, the late Mr. and Mrs. Dan M. Jones in 1879 and to Anson in 1882.

She married Walter F. Wright in Anson July 10, 1900. They lived there until 1929 when they moved to Roby. They operated a dry goods and grocery store in Roby until Mr. Wright's death in 1953. Since then, she has lived with her daughters.

Survivors are two daughters, Mrs. A. T. Eudaly of San Angelo and Mrs. John R. Lindsey of Hawley; four grandchildren; 6 great-grandchildren.

Mrs. W. J. Barrington of Roby, was to undergo surgery Tuesday in Callan Hospital. At news time we did not have a report on her condition.

Mrs. Fred Parker of Roby will enter Hendricks Hospital in Abilene Monday where she will undergo eye surgery.

Mr. and Mrs. Bobby Smith and family, Mr. and Mrs. Bobby Gruben and family, Mr. and Mrs. Glen Strickland and family and Mr. and Mrs. Charles McCall and family all went to Brownwood Lake for a few days last week.

Mrs. Buster Greenway had lunch with Mr. and Mrs. Lester Greenway and boys last Friday.

Mrs. Dave Foreman visited Mr. and Mrs. Jack Wiley last weekend and had lunch in the home of Mrs. C. C. Roach Monday.

Mrs. Ruby Cave of Rotan has returned from a trip to Dallas visiting relatives. Mary Beth Aaron and Lisa Lilly returned home with Mrs. Cave for a few days visit in Rotan.

Mr. and Mrs. Charles Thornton, David and Jenna of Sotan, spent last weekend in Lubbock visiting Mr. and Mrs. Mike Thornton.

Visiting in the Andrew Pearce home, Rotan, over the weekend were their children, grandchildren, and great grandson. Mr. and Mrs. Boyd Blythe, Lita and Leslie of Alvin; Mr. and Mrs. Ronnie Blythe of Katy; Mr. and Mrs. David Blythe and Chris of Houston and Mr. and Mrs. Glen Herbert of Houston. Mr. and Mrs. Pearce attended the Blythe reunion in Sweetwater Sunday.

Mrs. Tom Montgomery, the former Shirley Bridges, and children are spending the summer in Philadelphia, Pa. Mrs. Montgomery's husband, Tom, takes care of race horses there.

Visiting Mr. and Mrs. Arlon Cross and Mr. and Mrs. Walter Cleveland this weekend were Mr. and Mrs. Earl Patterson of Levelland. They all attended the Pleasant Valley reunion.

Mr. and Mrs. Bruce Cox and family of Rotan spent the weekend in Lamesa where they visited Bruce's sister, Mrs. Billie Willis who is recovering from surgery. Melody stayed for a longer visit.

Visiting Mr. and Mrs. John Cox this past weekend was Mrs. Gay Hargrove of Marble Falls, Belton Hargrove, grandson of Mr. and Mrs. Cox, is spending the summer with them.

Visiting Mr. and Mrs. Dave Posey, Rotan, this weekend were Mr. and Mrs. Charles L. Miller and family of Amarillo. Mrs. Kent Westbrook and family of Crockett, Mr. and Mrs. Richard Posey and family of Rotan and Mr. and Mrs. Ted Posey of Roby.

Mrs. Lavern Vanceil and Mrs. Jane Morrow of Ft. Worth visited Mrs. C. C. Roach last Sunday.



DAR OFFICERS: Officer of the recently organized chapter of the DAR are seated, left to right, Miss Delila Baird, Organizing Regent; Mrs. R. D. Evans, State Organizing Secretary. Standing, Mrs. Whit Clark, Vice Regent; Mrs. J. L. McCright, Recording Sec.; Mrs. L. R. Baates, Corresponding Sec.; Mrs. J. R. Strayhorn, Historian; Mrs. H. G. Thompson, Treas.; Mrs. Josie Baird, Registrar.

Delila Baird Regent

Rotan members of Daughters of the American Revolution met June 9 in the home of Mrs. Whit Clark for the purpose of organizing a chapter in Rotan. Officiating for the Organization and Installation of officers was Mrs. R. D. Evans, State Organizing Secretary of Devers, Texas.

Miss Delila Baird, Organizing Regent, called the meeting to order. Scripture was read by Mrs. J. R. Strayhorn who also led the group in prayer. The Pledge to the Flag of the United States of America, and the American's Creed were recited in unison.

Miss Baird introduced Mrs. Evans who addressed the group briefly before installation of officers for the proposed new chapter. Installed were: Miss Baird, Regent; Mrs. Whit Clark, Vice-Regent; Mrs. James B. Day, Chaplain; Mrs. J. L. McCright, Recording Secretary; Mrs. Lester R. Baates, Corresponding Secretary; Mrs. H. G. Thompson, Treasurer; Miss Josie Baird, Registrar; Mrs. J. R. Strayhorn, Historian; and Mrs. C. E. Atwell, Librarian.

Following installation, Mrs. Evans declared Anne Pettus Shelburne Chapter of Daughters of the American Revolution as officially organized. Miss Baird then placed a call to the Headquarters of the National Society in Washington, D. C., to report the completion of organization of the new chapter, in order for it to be confirmed by the National Board of Management, which was in session.

Mrs. Evans spoke briefly on the 1972 meeting of Continental

Congress in Washington, D.C. in April. She showed a display of DAR Bicentennial realia including sheet music and words for the song, "A for America". Haviland China Bon-Bon dish made especially for DAR by the company; Bi-Centennial Medallion, plate and tile. The organizational meeting was concluded with a salad luncheon.

Members of the New Chapter in addition to the officers are: Mmes. Ulmont Allison (Boerne, Texas), Kennis R. Baskin (Houston), A. A. Bostick, W. W. Heathington, E. C. Jones (Alamogordo, N. M.), Norvella Kennedy, Bennie LeBleu, J. E. Lincoln (Lamkin, T. R. Locke, Jr. (Big Spring), Misses Paula Heathington and Anne Pettus Shelburne (Washington, D. C.). Also, Chapter members preparing application are Mmes. Bobby Gruben, Rudy Hamric, Jim Hale; and Miss Joyce Baates.

The chapter name, Anne Pettus Shelburne, represents two prominent families of the Revolutionary era. She was the daughter of Col. Thomas Pettus, a member of the Virginia House of Burgesses from Lunenburg County, and a signer of Protests against the British. Her husband, Rev. James Shelburne, was a well known Baptist Minister of Virginia. Many descendants moved to Texas. Anne Pettus Shelburne is an ancestor of Mmes. Allison, Baates, Bostick; the Misses Bairds and Shelburne; and chapter members Miss Joyce Baates and Mrs. Bobby Gruben.

Churches Plan Dads Day Events

Sunday is Father's Day. Some Rotan churches will recognize the Fathers of their church. The Calvary Baptist Church will recognize their Fathers and give them their gratitude for their support in all things the church attempts to do.

Cross Roads Baptist Church will recognize their fathers. To the oldest and youngest father in the Church Sunday they will present a gift.

The First Baptist Church will recognize their fathers and Bro. Fred Thomas will present a message on fathers.

Wednesday, June 14, at 3:00, the First Baptist Church held a special Father's Day service at the Fisher County Nursing Home. Tomorrow, Friday, June 16, a special Father's Day Service will be held at Crestview Lodge at 3:00 in the afternoon. The public is invited to attend this special service.



ATTENDING LUNCHEON: Left to right, Virginia Lewis, Billie Holcomb, Carlene Moore, Patsy Stewart, Frances Arrington, and Joretta Browning.

Mrs Frances Arrington

Mrs. Frances Hall Arrington of Atlanta, Ga. entertained with a brunch in the home of her parents, Mr. and Mrs. Farrest Tefeller, Roby, recently. The brunch

Mrs Frances Arrington

was in honor of friends and former Roby classmates.

Those attending were Carlene Bolton Moore, Houston; Joretta Moore Browning, Andrews; Virginia Minnick Lewis, Dallas; Billie Etheredge Holcomb, and Patsy Sumner in Stuart of Roby.

Lueders Men's Rally

The Baptist Men's Rally will be Friday, June 23, at Lueders Baptist Encampment beginning at 6:30 p. m. with the evening meal. The program is to begin at 7:30 p. m.

Guest speaker for the rally is to be C. J. Humphrey, President of Texas Baptist Men.

The Associations to be represented at this meeting will be Cisco, Callahan, Abilene, Haskell-Knox, Sweetwater and West Central.

Those from Rotan attending the funeral of Mrs. E. E. Wright in Dublin June 8 were Mr. and Mrs. B. W. Rivers and Mrs. Mac Rivers. Mrs. Wright was mother of Mrs. Horace Arrington, Rotan.

Visiting in the home of Mr. and Mrs. Horace Arrington in Rotan recently was their grandson Kevin Arrington from Atlanta, Ga.

Hobbs HDC Has Time Change

The Hobbs Home Demonstration Club met with Mrs. Connie Tutt Thursday, June 8, at 2:30. Roll call was answered with "Something nice to do for someone in sorrow". Mrs. Walter Byrd called the meeting to order.

Mrs. James Nettleton and Mrs. James Lay gave an interesting program on "Planning and Financing Funerals". Refreshments were served to members present and one visitor, Mrs. Clarence Anderson.

The next meeting will be Thursday, June 22, at 3:00 instead of 2:30.

Engagement

Mr. and Mrs. Bill Starnes of Rotan announce the engagement of their daughter, Mickey, to Johnnie Farris, son of Mr. and Mrs. C. D. Ferris of Rotan. The wedding will be July 4.

Bro. Jack DeWitt, pastor of the Calvary Baptist Church, and other men from this area have just returned from a trip along the Rio Grande. They did some carpentry work and other chores getting ready for the Vacation Bible School and revival to be held later this summer for the River Ministry.

The men remodeled an old mission, making it into a dormitory for the boys and girls while they are helping in the Bible School and revival.

Roger Graham On Deans List

Roger Graham of Rotan was among 485 students in the College of Engineering at Texas Tech University that qualified for the dean's honor list for the 1972 spring semester.

To qualify for the honor list, a student must be enrolled in 12 semester hours of courses, and have at least a 3.0 grade point average on a 4.0 system.

Mrs. L. N. Dennis, Mrs. Ted McArthur and Regina visited their sister, Mrs. Albert Mueller in Hawley last Friday. Also visiting Mrs. Mueller was her daughter, Mrs. Bill Johnson from Nebraska.

Visiting Mr. and Mrs. M. T. Wilson, Roby, last Friday was her niece of Haskell, Mrs. Rozelle Wilkison.

CARPET!

We Have A Good Supply Of Fine Quality Carpet At Reasonable Prices. Professional Carpet Installers Offer Guaranteed Satisfaction

See Us For All Your Carpet Needs.

LANDES FURNITURE
rotan, Texas

Rodeo Dance

June 15, 16, 17

Sponsored By "73 Club"

J.W. Brewer and His Auctioneers
COUNTRY AND WESTERN BAND
Admission \$2.00



The cooler the home, the warmer the marriage.

Marriages may be made in heaven, but it's hard to keep them heavenly when it's hotter than blazes.

That's where central gas air conditioning comes in. It can bring you together. All summer long. As close as you want. All summer long.

And it won't cost you much either. In fact, if you have gas heating in your home, you could easily have half a central air conditioning system already. Because you may be able to use the duct work and furnace blower you already have. That saves about fifty percent on installation costs.

That's just part of the savings. Gas costs less to operate than electricity. And gas air conditioning owners get special low rates during the long hot summer months.

But you'll save more than money with gas. You'll save time and energy, too. Because with central gas air conditioning, there are fewer moving parts, fewer breakdowns, fewer repairs.

This summer, have central gas air conditioning installed. For love's sake.

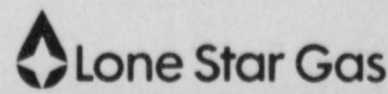

See Your Gas Air Conditioning Dealer.

Shop Around For Diamonds Watches & Jewelry ... but make **Champion Jewelry** your last stop

"Home owned - operated" **Expert Watch Repair**

735-3494
111 W. Snyder Rotan
Ruby & Cecil Champion

SPECIALS
JUNE 15
JUNE 16
JUNE 17

HAYES FOOD MKT.

DEL MONTE CORN 4 FOR 99¢
CREAM STYLE

CARROTS 1# PKG 2 FOR 25¢

DEL MONTE 1/2 OR SLICED PEACHES 3 FOR 99¢

DEL MONTE CUT GREEN BEANS 4 FOR 99¢

DELSEY 4 ROLL TISSUE 59¢

KLEENEX 120 COUNT TISSUES 4 FOR 99¢

HUNTS TOMATO JUICE #300 2 FOR 29¢

GLADIOLA FLOUR 5 LB 55¢

ARM ROAST 89¢ LB.

BEEF RIBS 59¢ LB.

CHUCK ROAST 79¢ LB.

HORMEL RED LABEL BACON 69¢ LB.

POTATOES 10 LBS 55¢

THIS COUPON WORTH 30¢ toward the purchase of INSTANT LIPTON TEA HAYES GRD.
Expires JUNE 22, 1972
Limit One Per Family

ATTEND 16th ANNUAL AMATEUR



Rotan, Texas

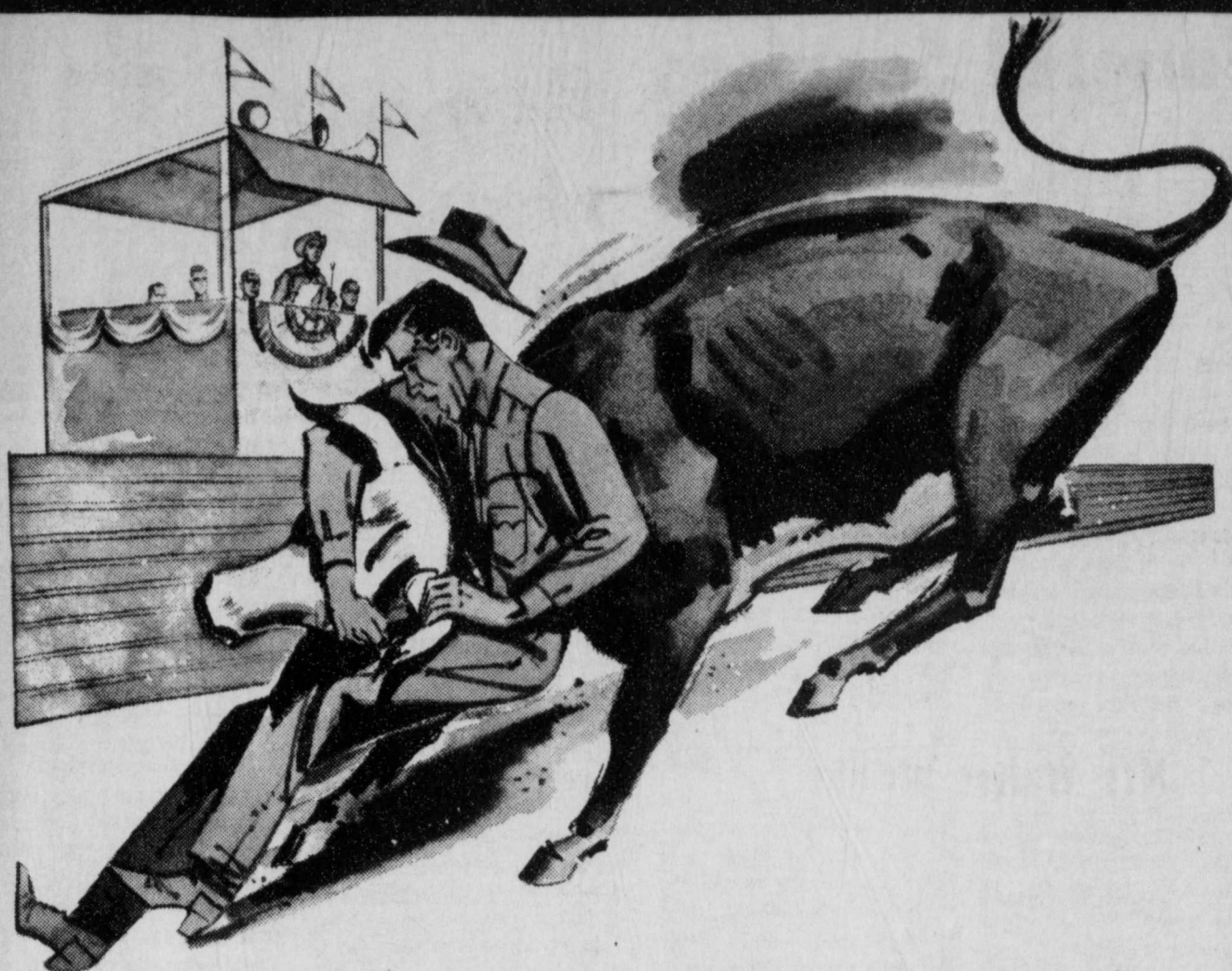

JUNE 15-16-17 FISHER COUNTY SHERIFF POSSE

Rodeo Parade
June 15th 5:00 p.m.
Trophies

Rodeo Stock Furnished By
Adrian Parker
St. Jo, Texas

Sponsored By

**FISHER COUNTY
SHERIFF POSSE**

Brazos Transport Co.		National Gypsum Company		Farmers Gin		Winns	
Rotan Flower Shop 735-2261						Gandys Products BILLY HENDERSON	
Hātahoe ROTAN, TEXAS						Rotan Insurance Agency JOE DALE BURK	
Rotan Gin Company ROTAN, TEXAS						Rotana Restaurant AND EMPLOYEES	
Farm Tractor & Service, Inc. YOUR JOHN DEERE DEALER ROTAN, TEXAS		Rotan Motor Co FORD AND MERCURY 735-2201 ROTAN, TEXAS		Smith & Cyphers YOUR GULF DEALER		Home Lumber Co. BUILDING MATERIAL FOR HOMES, FARMS, AND RANCHES.	
Dardens Dept. Store		City Auto Supply 216 W. SNYDER AVE. ROTAN, TEXAS		Rotan Seed Delinting Co.		Clinic Pharmacy ROTAN, TEXAS	
Garcia Conoco Station FLAT FIXED 735-8023		H.L. Davis Co. 735-2591 ROTAN, TEXAS		Kash Foods BILLY GREEN - OWNER ROTAN, TEXAS		COMPLIMENTS OF Atwell Cleaners	
Whites Auto Store		Champion Jewelry 735-3494 ROTAN, TEXAS		Frazier Drug Co. ROTAN, TEXAS		Glen's Thriftway DOUBLE GOLD BOND STAMPS WED. YOUR BUSINESS IS APPRECIATED	
RODEO		Rotana Motel		Landes Furniture 735-3171		F & M Chevrolet - Buick 735-2244 ROTAN, TEXAS	
Sandy's Beauty Shop		First National Bank		Rotan Advance		Weathersbee Funeral Home 735-2255 ROTAN, TEXAS FUNERAL INSURANCE	
Rheta Thomson				Roby Star-Record			



For Res Nati
Mildre
ected
can Seco
1972. acc
principal
Nomin
By the so
rs, Blac
this nati
of her pr
achieve
Mrs. Bl
of Mr
and the l
a gradu
and Mary
son, Tex
work at T
universit
Los Ange
in the Sp
Ch
Fo
In a spe
annual M
Church, T
Christ. Sc
o June 5
new Chai
Science B
el on the
themselv
of Christi
"Each o
perative o
eared. sp
great nee
dction an
aterials
Firshan
ense pra
ealing is
Wednesda
ings held
Sweetwat
ing to Mrs
sistant Co
tion for Re
Fulfillm
purpose de
less than C
Lightner
Mr. Wuth
"We urge
ad each
measure th
light of th
tion to the
he declar
It was an
ing that th
ministrati
story Chur
film and
would be
year.
Mr. and
ran. have
tour of We
to Lubbo
Hardin. V
te Brownf
Denver C
they visit
Wathen an
at Lake.
J. ColT
Ms. Leve
in Rotan v
bell.
Visiting
Cross, Rot
Naggle Y
IN
TU
A TO

JUNE is

DAIRY MONTH

**T
H
R
I
F
T
W
A
Y**

For Your Cookouts!

U.S.D.A. CHOICE
T-Bone Steak LB. **\$ 1⁰⁹**



SIRLOIN U.S.D.A. CHOICE
STEAK LB. **99¢**

ROUND U.S.D.A. CHOICE
STEAK LB. **\$ 1⁰⁹**

GLADIOLA
FLOUR
25 LB BAG **\$1⁹⁸**



Jello
3 OZ.
10¢

Hormel Black Label
Sliced Bacon lb. **79¢**
Hormel
Little Sizzlers 12-oz. **69¢**
Hormel Vac Pak
Wieners 12-oz. **59¢**
Leo's Sliced Ham, Dark Turkey or
Sliced Beef 3-oz. **39¢**
Leo's Sliced
Corned Beef 3-oz. **49¢**

NEW 29 OZ.
PILLSBERRY
3 FLAVORS
**Bundt
Cake Mix**
89¢

SPORTSMAN'S KNIFE OFFER!
See package for details.

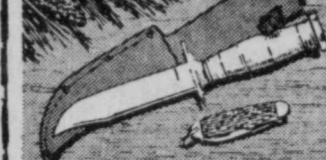

**Hormel
RANGE BRAND
BACON \$1⁴⁹**
Sliced thick on purpose. 2-lb. Pkg.

FAB 10¢ Off Label

Detergent
Giant **59¢**
With coupon Below



5 POUNDS
SUGAR
58¢
With \$7.00 Or More
Purchase. Excluding
Cigarettes.
LIMIT ONE

TV Special
FRESH CALIFORNIA FRESTONE
PEACHES
29¢
lb.



Folger's Mountain Grown

Coffee
3-lb. Can **\$2²⁹**
With coupon Below

MORTON FROZEN, ASS. FLAVORS
CREAM PIES ... 3 14-oz. **79¢**
Morton All Varieties
Frozen Dinners Your **39¢**
Choice

GANDY 1/2 GALLON
FROZAN 3 FOR 99¢

Prices effective
June 15 thru 21, 1972
We reserve
the right to
limit quantities

Schilling's
Salad Supreme 2 3/4-oz. **55¢**
Jar

GANDY'S 24 OZ.
Cottage Cheese **59¢**

GANDY'S QUART
Sherbert **49¢**

On Sale This Week



Volume 7 \$1⁶⁹

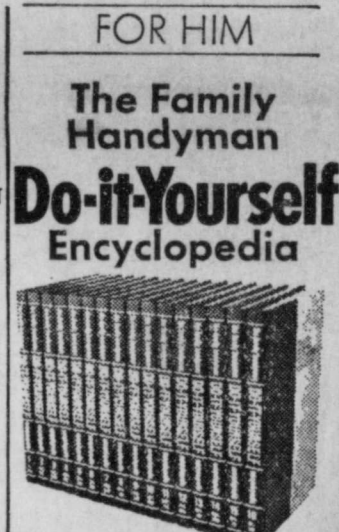

Volume 7 \$1⁶⁹

Dairy Specials!

Kraft, American or Pimento, Individually Wrapped
Sliced Cheese 12-oz. Pkg. **69¢**

Kraft
Velveeta Cheese 2-lb. Loaf **\$1²⁹**

Kraft Philadelphia
Cream Cheese 8-oz. Pkg. **39¢**

Kraft Parkay
Margarine 3 16-oz. For **\$1⁰⁰**

Kraft Sliced Halfmoon Longhorn
Cheese 10-oz. Size **69¢**

CALIFORNIA
Carrots 2 lbs. 29¢

California Hass
Avocados 3 \$1

Health & Beauty Aids

Protein 21
Regular or Hard to Hold
Hair Spray
13-oz. Can **99¢**

Effective
Bufferin 60's Size **99¢**
Hair Dressing
Score 3-oz. Tube **79¢**
Hair Tonic
Vaseline 3 1/2-oz. Size **79¢**
Ponds Regular or Lemon
Cold Cream Medium Jar **89¢**
Fem. Hyg. Mist. Spray
Pristeen 2.5-oz. Size **\$1²⁹**

VALUABLE COUPON
INSTANT Maxwell House
10 oz. Jar **Coffee**
with coupon **99¢** without coupon **\$1⁶⁹**
Redeemable at THRIFTWAY Stores
Coupon good May 15 thru June 21 1972

VALUABLE COUPON
Baggie
Trash Bags
30-Gal. Size Pkg. of 10 with coupon **39¢** without coupon **59¢**
Coupon valid June 15 - 21 1972
Redeemable only at Thriftway

VALUABLE COUPON
Fab, 10¢ Off Label
Detergent
Giant Size with coupon **59¢** without coupon **79¢**
Coupon valid June 15 - 21 1972
Redeemable only at Thriftway

VALUABLE COUPON
Folgers Mountain Grown
Coffee
3-lb. Can with coupon **\$2²⁹** without coupon **\$2⁶⁹**
Coupon valid June 15 - 21 1972
Redeemable only at Thriftway

Bama Apple Butter 44-oz. Size 69¢	Bama Apple Jelly 3 18-oz. Jar \$1⁰⁰	Nabisco Sandwich Cookies OREO 15 OZ. 53¢
Liquid Diet Drink Carnation Slender Assorted Flavors 10-oz. Can 29	Kleenex Boutique Facial Tissue 125's 3 for 89¢	Kleenex Boutique Bathroom Tissue 2-Roll Pack 2 for 59¢
Fisher's Vac Pak Mixed Nuts 13-oz. Can 98¢	Kleenex Boutique Towels Jumbo Roll 2 For 77¢	Folgers Mountain Grown Coffee 1-lb. Can 89¢ 2 lb. can \$1⁷⁷
Skinner's Short Cut Elbo Macaroni 12-oz. Size 27¢	Shurline Mayonnaise 32-oz. Size 49¢	

MINT FLAVORED
PHILLIPS' TABLETS
MILK OF MAGNESIA
ONLY **79¢**
75's Tablets

**Tender Crust
Bread 1 1/2 # Loaf**
3 for 89¢

**GLEN'S
THRIFTWAY**

GOLD BOND STAMPS
ROTAN, TEXAS



Vickie Lynn Smart And Rickey Jeffrey United



Vickie Lynn Smart and Rickey Alan Jeffrey were married Saturday, June 17, at the McCaulley Baptist Church.

The Rev. Buddy Sipe, minister of West Side Baptist Church of Sweetwater, officiated. Pianist was Mrs. Buddy Sipe.

The bride is the daughter of Mr. and Mrs. James Giddion Smart Jr. of McCaulley. Parents of the bridegroom are Mr. and Mrs. Avis Jeffrey also of McCaulley.

Matron of honor was Mrs. Bobby Smith of McCaulley. Bridesmaids were Tiny Ann Smart, sister of the bride and Nancy Wall of Hamlin.

Pamela Kay Haught of Idalou was flower girl. Kerry Jeffrey of Corvallis, Ore., was ring-bearer.

Best man of McCaulley was Bobby Smith. Groomsman were Jim-

my Mack Jeffrey of Corvallis Ore., and Ronnie Jeffrey of Irving, brothers of the groom.

Ushers were SP. 4 James L. Smart, brother of the bride, and Eddie Wayne Gibson of McCaulley.

Kenneth Smart, brother of the bride, lighted candles. Jana Jeffrey registered guests.

Given in marriage by her father, the bride wore a gown of white peau de soie with cathedral train, accented with lace appliques and seed pearls. Her elbow length veil was held with white spring flowers of satin and organza. She carried a bouquet of pink sweetheart roses.

The bride's attendants wore empire gowns of pink moire taffeta with raspberry lace bodice. The flower girl's gown was pink dotted swiss with raspberry velvet bow at the waist.

The bride, a spring graduate of McCaulley High School, was valedictorian of her class. The bridegroom, also a graduate of McCaulley High School, attended Cisco Jr. College.

After a short wedding trip, the couple will be at home at 108 E. Louisiana in Sweetwater where he is employed by USG.

The bridegroom's parents hosted the rehearsal dinner.

Rotan Methodist VBS Beginning June 26th

The First United Methodist Church of Rotan is having their Vacation Bible School next week, June 26 through 30. The sessions will be from 2 p. m. to 4 p. m. each afternoon. Everyone is invited to attend.

nursery age through 13 years. Director of the school this year is Mrs. Lawrence Brede-meyer. Those working and helping her are: nursery, Cindy Kiker, Melody Cox and Susan Hunsaker; kindergarten, Grace Thompson and Sarlotte Thom-son; elementary I and II, Karen Helms and Gail Williams; Ele-mentary 3 and 4, Trudy Clements and Kathy Tibbles; Ele-mentary 5 and 6, Diane Dycus and Regina McArthur; Refresh-ments, Pat Hamric; and Music, Mary Ann Marshall.

First Baptist Planning New Photo Directory

The First Baptist Church of Rotan has begun work on a new Church Directory. United Church Directory of Waco will make the pictures, according to church officials. Families of the First Baptist Church will be contacted when the pictures will be made. There will be no charge for the pictures unless the family wants a picture for themselves. There will be more information about this at a later date.

Friday night, June 23, the Baptist Men's Rally will be held at Lueders. Mr. C. J. Humphrey, president of Texas Baptist Men, will be the speaker. Supper will be served at 6:30 p. m. (\$1.50 per person) and the program is to begin at 7:30.

All this week the Act-teens have been attending camp at Lueders. Lynn Oglesby is camp director.

Cross Roads Honors Dads

The oldest father at the Cross Roads Baptist Church last Sunday was Danie Gruben, and the youngest father was Donald Gruben. A tie clasp was presented to each of the men during the morning worship service.

The church is in the process of making a pictorial directory. The pictures will be made Sunday, June 25, at the church from 1 p. m. till 6 p. m. in the afternoon. The church has tried to contact all the families of the church, but if someone has been missed, be sure and be at the church Sunday afternoon. There is no cost for the pictures, unless the families want one for their personal use.

The Teen and Youth time has been set at Crossroads Baptist Church for June 26 through June 30, at 7:30 till 10:00 each night. There will be a devotional time, Bible Study, singing and a special feature each night that will be a complete surprise.

Everyone is invited to attend this week of special devotion.

Noemi Jinojosa And A. Medrano Married

Noemi Jinojosa and Arthur Medrano were married May



21 in Weslaco, Texas. Parents of the couple are Mr. and Mrs. Benito Jinojosa of Weslaco and Mr. and Mrs. Alfred Medrano of Rotan.

Seaton Family Holds Reunion

Mr. and Mrs. O. C. Ashton of Rotan and their children met in Brownfield recently for the Seaton family reunion.

Others present were Mr. and Mrs. Bill Settle, Red Oak; Mr. and Mrs. Buck Buckingham, Fay, Dan and Sam, Jimmie Austin and Mr. and Mrs. Jerry Tallman and children. Mrs. W. C. Ashton, Doug, Dan and DeAnn, Phenix, Ariz.; Mr. and Mrs. Don Ashton, Lady, Melody, Landy, Trudy and Mrs. Frank Rojas and baby, Lubbock; Mr. and Mrs. De-arl Ashton, Dale and Teresa of

Rotan Golf Club Sets Tournament

The Rotan Golf Club has set the dates for their annual partnership tournament June 30, July 1 and 2.

Friday and Saturday partnerships will play 18-hole qualifying round with a tested score which will be used to flight the

players in Sunday's final 18 hole play.

Flights will be made according to stroke differences. Trophies will be given in 3 flights to winners and runners-ups.

Entry fee for members is \$2.50 and \$3.50 for nonmembers. Additional information may be obtained from Arvin White, Club secretary.

Dr. and Mrs. Frank Johnson of Rotan, Annie Laurie Johnson and Carrie Johnson of San Antonio have returned from a trip to Sioux Falls, S. D. where they visited their sister, Janie Mae Johnson.

Mr. and Mrs. Keifer Curlee and family visited in the home of his sister and husband, Mr. and Mrs. Max Stuart of Roby. Last week.

Rebels Hand Pirates First Loss Of Season

Due to the rodeo last week the Little League played two double headers last week on Monday and Tuesday nights.

The Pirates got beat for the first time last week on Monday June 12, at 5:30, The Rebels, pitching Joe Medrano, won the game 7 to 5. Wes Morrow pitched for the Pirates.

Monday night, June 12, at 8 o'clock, the Yankees and Vets played. Dale Roa pitched for the Vets and Gary Dickson for the Yankees. The Vets won the ball game with the score 8 to 6. It was tie game on some innings, a real hair raiser of a game. Donald Odum and Johnny Medrano played on the Yankee team for the first time Monday, making the Yankees a full team once again.

Monday night, June 12, the Colts played at Anson to be defeated 13 to 9. The Colts pitched Vic Wilkinson and Brent Jones.

Tuesday evening, June 13, at the Minor League practice field the Colts and Hawks met. Mark Pope and David Posey pitched for the Colts. The Hawks pitchers were Clu Burnham, Dean Nichols and Ernest Carrillo. The Colts won the game 15 to 8.

At 5:30 Tuesday, June 13, the Vets and Rebels met for a hard hit ball game. The Vets won 15 to 8. Mark Cooper pitched for the Vets and Blake Hale for the Rebels.

Tuesday, June 13, at 8 o'clock the Pirates and Yankees played. Michael Acorn pitched for the Pirates striking out 12 batters. It was a well pitched game holding the Yankees to a 0 on the score. The Pirates had 10 and Yankees 0, the game was called on the 10 run rule. Pitching

for the Yankees were Greg Hayes and Mark Nowlin.

Tuesday night the Cotton Belt Senior team played Hamlin at Rotan. Rotan won the game 10 to 1. Randy Smith and Joe Vann pitched for the Rotan team.

Thursday games were cancelled because of the rodeo.

Friday night, June 16, the Cotton Belt Senior team played Aspermont at Aspermont. Eddie Medrano, Randy Smith, and Joe Vann pitched for the Rotan team. Rotan won the game by a score 11 to 1.

As of Friday night, the Little League standings were: Pirates won 13 games, Rebels 6, Yankees 5, and the Vets 4.

Doc Hewitt of Chillicothe, Tex spent the weekend with Mr. and Mrs. Tommy Helm recently.

Visiting Mr. and Mrs. C. C. Carter, Rotan. Last week were Mr. and Mrs. A. L. Carter of Stamford, Mr. and Mrs. Roy Carter and Roy Lee of Snyder, and Miss Barbara Carter, student at HSU, Abilene, also, Larry Singley of Lubbock.

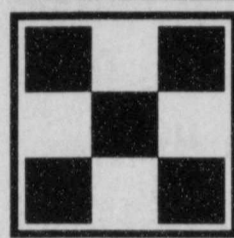

YOU AND YOUR HORSE WILL LOVE OUR RUB-ON INSECT REPELLENT AND KILLER WHICH ALSO HAS A GROOMING OIL BASE. WATCH YOUR COLTS GROW ON PURINA BIG UN. HAVE HORSE AND MULE FEED. KILL FLIES THE EASY WAY WITH PURINA CHECK FLY BLOCKS. WE ALSO STOCK MARLATE 50 FOR USE IN DUST BAGS OR AS A SPRAY OR DIP.

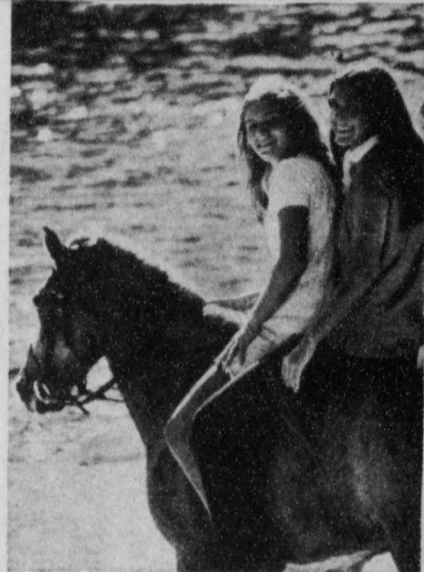

Fisher County Farm & Ranch Supply

The Jack McClures
776-9218 E. Hwy 180 Roby, Texas

Buy a Hesston Brush Cotton Harvester Before June 30

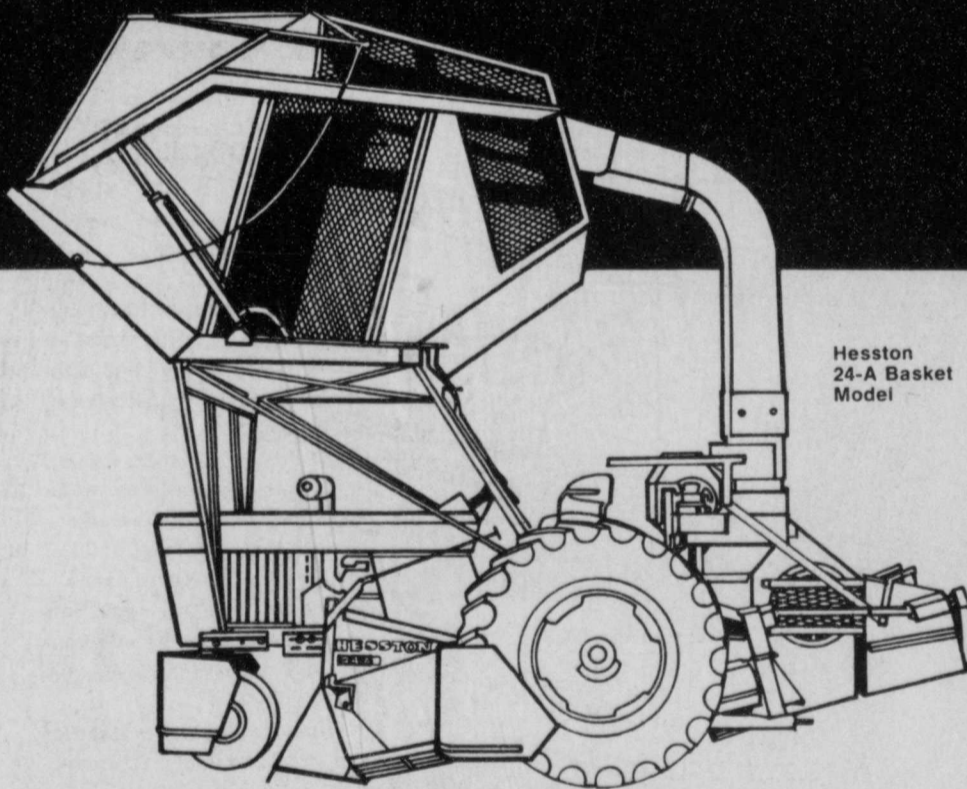

...and get a 1972 machine at a 1971 price!

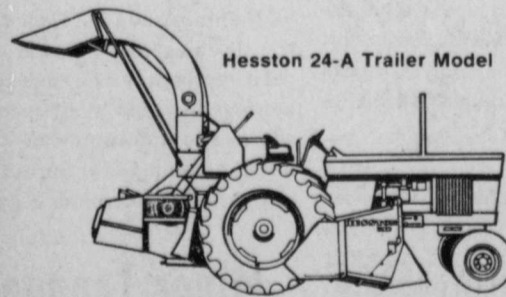

BASKET OR TRAILER MODEL
You can have the benefits of Hesston Brush Harvesting in your choice of trailer or basket models. Reversible spout lets you start with the trailer model, add a basket later if you wish. Front-dumping basket has 485 cu. ft. capacity. Buy now and save money on either model.

HESSTON
Hesston Corporation, Hesston, Kansas 67062 CHS-372

Buy a Hesston Brush Harvester now, and you'll profit two ways. First, you'll save money because you can buy a new machine at the 1971 price. That means you'll be getting improvements such as row units that adjust from the tractor seat at no extra cost. You'll profit again at harvest time, because the Hesston Brush Harvester mounted on your tractor gives such a fast, clean, once-over harvest. The Hesston air elevator has proven to be outstanding in green boll separation, and the brush harvesting system was established long ago as a thorough, gentle method that gets the cotton and leaves the trash. Hesston fits more makes of tractors than any other brush harvester. See the 1972 Hesston Brush Harvester at your Hesston dealer's, and see how much you can save if you buy before June 30.

L.V. Armstrong Implement

Roby, Texas

Phone-766-2110

New Prices

DUE TO THE RECENT PRICE INCREASES

TO US, WE HAVE FOUND IT NECESSARY TO ADJUST OUR PRICES TO OUR CUSTOMERS AS FOLLOWS.

- Shampoo & Set (WITH TEASING) \$3.00
- Shampoo & Set (Without Tease) \$2.50
- Shampoo & Set (LONG HAIR) \$4.00
- Comb Out \$2.00 - \$2.50
- Hair Cut \$2.00
- Six Week Color \$6.50
- Tint \$8.00
- Conditioner \$1.00
- Wiglets (CLEAN & COMB) \$3.50
- Wiglets (COMB) \$3.00
- Synthetic Wigs (CLEAN & COMB) \$5.00
- Synthetic Wigs (COMB) \$3.50
- Lash & Brow \$2.00
- Arch \$1.50
- Permanents \$10.00 up

PRICES EFFECTIVE JUNE 26th, 1972

- BEAUTY BAR DIANNE'S BEAUTY SHOP
- RHETA THOMSON JOYCE'S BEAUTY SHOP
- SUE'S BEAUTY SHOP SANDY'S BEAUTY SHOP
- DOROTHY'S BEAUTY SHOP

Shop Around For Diamonds Watches & Jewelry ... but make

Champion Jewelry

your last stop.

"Home owned - operated"

Expert Watch Repair
735-3494

111 W. Snyder Rotan
Ruby & Cecil Champion

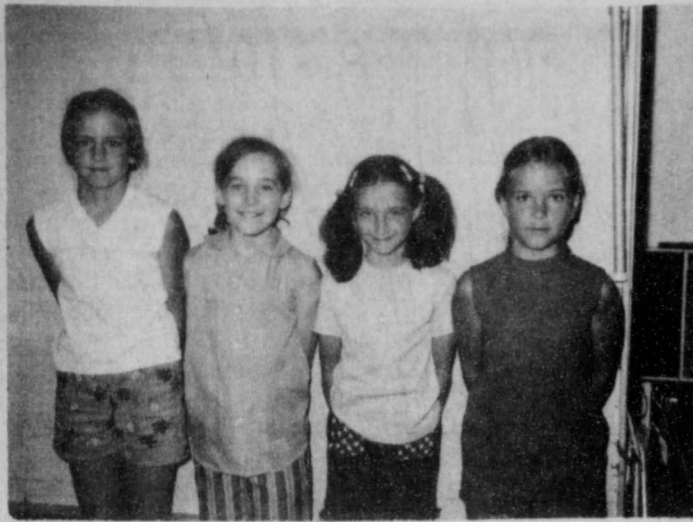

BUSY BETSIES: These 4-H girls, the Busy Betsies, have just completed a four-day clothing workshop conducted by Mrs. Bennie LeBlau. They are, left to right, Becky LeBlau, Julie Posey, Kayla Tibbles, and Lynda Henderson. The County Dress Revue will be July 20.



FIRE FIGHTERS: James Mann and Carlton Burrow, two members of the Rotan Volunteer Fire Department, help put out the air conditioner fire at the home of Mr. and Mrs. Bert Rushing last Tuesday afternoon.

Mrs. B. Bigham Elected THDA State Delegate

The Rotan Home Demonstration Club met with Mrs. G. C. Shell Thursday, June 15, at 3:00.

Mrs. Barney Bigham, president, welcomed three visitors. Mrs. A. M. Brewer of Lubbock, Mrs. W. R. Schubert of the Longworth Club, and Mrs. Z. H. Anderson of the Center Club.

Mrs. Ben Hargrove read the minutes of the last meeting.

Miss Mary Posey was elected T.H.D.A. delegate for the council meeting. Mrs. Barney Bigham was elected delegate to the state meeting in Houston in September.

Mrs. A. W. Brewer showed a film on Tuberculosis. She is the program assistant of the West Texas Area on Tuberculosis and respiratory diseases. This area covers 21 counties which includes Fisher County. Mrs. Brewer stated tuberculosis is spread from one person to another by germs carried through the air—it is not spread by dishes, books, clothes, or bed linens. Medication is the cure for tuberculosis. Chest x-rays, fresh air and sunshine, good food, do not cure

Vickie Smart Given Shower

Vickie Lynn Smart, bride-elect of Rickey Alan Jeffrey was honored with a bridal shower Friday, June 9, at the McCaulley Homemaking Cottage.

Hostesses were Mrs. T. E. Green, Mrs. Virgil Smith, Mrs. Ted Abbott, Mrs. A. C. Thompson, Mrs. O. F. Hill, Mrs. A. A. Smith, Mrs. W. T. McCright, Mrs. W. D. Cleveland, Mrs. Bobby Smith, Mrs. Harvey Dowell, Mrs. Wylie Baker, Mrs. Ellen Galloway, Mrs. John Ed Reed, Mrs. Fred Kemp and Mrs. Grank Kemp.

Special guests were the honoree's mother, Mrs. James Smart Jr. and Mrs. A. W. Jeffrey, mother of the prospective bridegroom.

Jimmy Laurie Attends 2 Day Cattle Meet

Jim Laurie, Roby Voc-Ag teachers attended a 2-day cattle grading workshop in Abilene hosted by West Texas Utilities and the Texas Ed Agency. Eddie Kimbrell, livestock specialist for the USDA held the workshop.

Kathy Graham On Tech List

Kathy Graham, Rotan, was on the Dean's List at Texas Tech University for the past 2 semesters. The List is composed of those students who have maintained a grade point of 3.0 or better during the semester.

Kathy is majoring in pre-nursing and will be a student at Methodist School of Nursing in Lubbock next fall. She is the daughter of Mr. and Mrs. Carroll Murphree of Rotan.

Mr. and Mrs. oe Ballenger of Roby had as Father's Day visitors, Mr. and Mrs. Keith Klepper, Bobbie and Richard of Midland and Mr. and Mrs. J. L. Ballenger and Karri of Sweetwater.

Mr. and Mrs. Charles Kelly and Mr. and Mrs. Kenneth Kelly of Rotan visited in Midland last weekend with Miss Leora Huggins.

Mrs. Ollie McCombs and Mrs. L. E. Newton, Rotan, have returned from a visit in Midland with Mr. and Mrs. L. E. Newton, Jr. and family.

Longworth HDC June Meeting

Longworth Home Demonstration Club met in the home of Mrs. Henry Guelker, recently. The house was called to order by President, Mrs. W. P. Schubert. Roll was called by Mrs. Guelker and answered with something nice you can do for someone who has lost a loved-one.

Handy-Andy was won by Mrs. Schubert.

Mrs. Guelker read the devotional and gave the treasurer's report and after a short business meeting gave the program on planning and financing funerals. Fact sheets were passed to each member to study and file.

The Club was adjourned and refreshments were served to Mmes. Malcolm Ballenger, B.F.

McGee, Richard Shedd, W. P. Schubert, J. W. Landers and the hostess.

Next program will be on Respiratory Diseases, June 26, at the home of Mrs. Richard Shedd. Anyone interested in hearing the program is welcome to attend.

Visiting Mr. and Mrs. J. E. Van Loon, Rotan, last weekend were Mr. and Mrs. Howard VanLoon, Shane and Kimberly of Waco; Mr. and Mrs. Larry VanLoon of Abilene; Carolyn VanLoon of Abilene and Mrs. Aubrey Trout of San Antonio.

Mr. and Mrs. H. F. Railsback of Meridian visited Mr. and Mrs. C. C. Carter and other friends in Rotan last week.

During the month of June we will feature Six Flags tickets for \$4.19 with each \$5.00 purchase.

This Offer Good Until June 30th. Tickets Are Good During 1972 Season

T-BONE STEAK \$1.29 LB.

CHUCK ROAST 79¢ LB.

ARM ROAST 98¢ LB.

LEAN GROUND MEAT 98¢ LB.

SLAB BACON 79¢ LB.

PAGE WEINERS 2 LB. \$1.19

ALL MEAT BOLOGNA 69¢ LB.

LIPTON INSTANT TEA 4oz. \$1.69

GANDY'S 1/2 GAL. PURE ICE CREAM 79¢

FRESHIE REG-50¢ POTATO CHIPS 39¢

GANDY'S COTTAGE CHEESE 24oz. 69¢

S & H GREEN STAMPS

WATSON LARGE EGGS Doz. 39¢

KEITH FROZEN 2# BAG POTATOES 39¢

CANNED COKES 10 FOR \$1.00

NABISCO TOAST-ETTES 3 FOR \$1.00

NABISCO CRACKERS L.B. Box 39¢

TROPHY STRAWBERRIES 10oz. EACH 29¢

KEITH FROZEN ROLLS PKG. 29¢

YELLOW SQUASH 15¢ LB.

LETTUCE 19¢ HEAD

CELLO 2 PKGS CARROTS 25¢

BANANAS 12 1/2¢ LB.

CANTALOUPE 19¢ LB.

BEN PEPPER 69¢ LB.

PRICES GOOD JUNE 22 THRU JUNE 28

735-2266 OR 735-2267 FOR DELIVERY

Double S & H STAMPS ON TUESDAY AND WEDNESDAY EXCLUDING CIGARETTES WITH 2.50 PURCHASE

The Alamo

THIS HISTORIC TEXAS MISSION WAS THE SCENE OF THE BATTLE OF A HANDFUL OF TEXANS AGAINST SANTA ANNA'S ARMIES IN 1836!

Seems like I do remember hearin' about that...

Don't battle paying bills ... "Remember", a checking account is your protection.

FIRST NATIONAL BANK of ROTAN

Each depositor insured to \$20,000

FDIC

Teresa Gay Hyatt And Donnie Kiker Plan Wedding

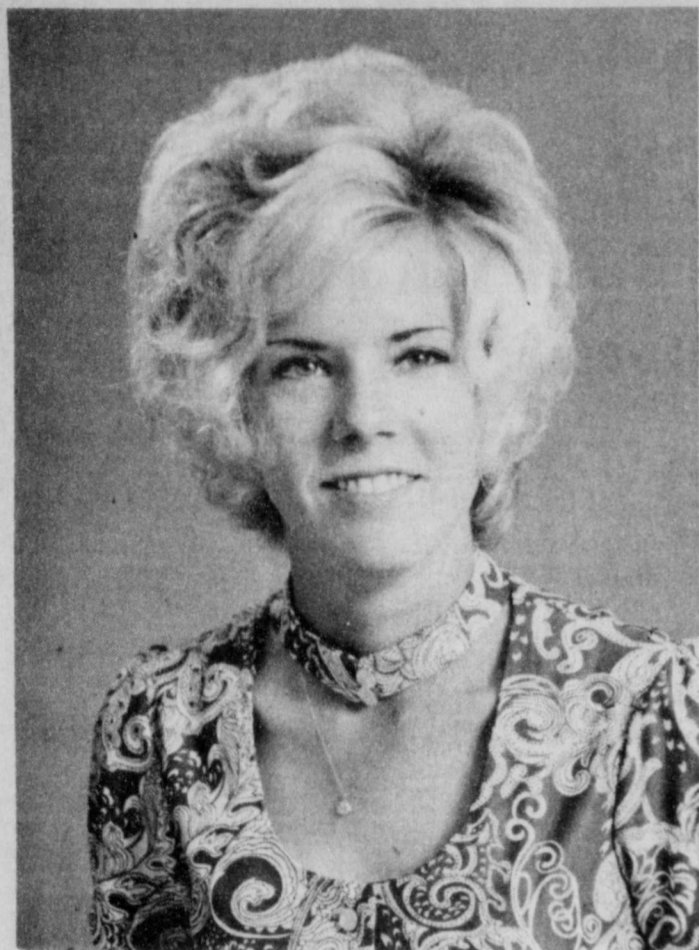

Mr. and Mrs. Rankin B. Hyatt of Burnet wish to announce the engagement and approaching marriage to their daughter, Teresa Gay, to Donnie Alton Kiker, son of Mr. and Mrs. H. A. Kiker of Roby.

The wedding will be August 5, in the First Methodist Church of Burnet.

The bride-elect is a 1968 graduate of Burnet High School and received her bachelor of science degree in physical education at Tarleton State College on May 14, 1972.

The prospective bridegroom is a 1964 graduate of Roby High School and will receive his bachelor of science degree in Agriculture Education in August from Tarleton State College.

Grandson Of Tom Terry Will Wed

Mr. and Mrs. Guinn Sammons of Palestine, Texas, announce the engagement of their daughter, Guindlyn LaNell, to Tommy James Gunnels, son of Mrs. Inalee Gunnels of Elkhart, and the late Edward Gunnels.

The bride-elect is a graduate of Westwood High School and attends Nixon's Business College.

The prospective bridegroom attended Tyler Junior College following graduation from Elkhart High School. He is employed by Texas Power and Light Company, and is presently serving with the National Guard at Ft. Knox, Ky. He is the grandson of Mr. and Mrs. Tom Terry of Longworth.

The wedding will be July 14.

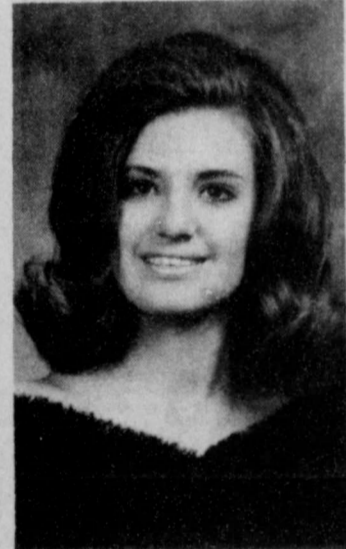

Guindlyn Sammons

Mrs. C. E. Leon, Rotan, attended the funeral service last Friday of her aunt of Abilene, Mrs. John Roach.

Mrs. C. E. Leon, Rotan, and her sister, Mrs. J. E. Geer of Rule attended a luncheon at 12:30 Saturday honoring their cousin Miss Kaye Galbraith of Abilene at the Abilene Country Club. They remained over and attended the wedding at the Pioneer Baptist Church of Miss Galbraith and Mr. Travis Hartgraves at 8 p. m.

FARM & RANCH LOANS
Through The Federal Land Bank Association of Roby
Ralph C. South, Manager, 915-766-2321

STAMFORD FEDERAL SAVINGS AND LOAN ASSOCIATION

122 McHarg, Stamford, Texas
P. O. Box 511-Phone 773-2714

The Fastest Growing in the Big Country

Where thousands have come to utilize our personalized service to place their savings for safekeeping with interest.

Rotan WMS Has Monthly Meet

The Rotan WMS met Wednesday, June 14, at the Fisher County Nursing Home to present a Father's Day program. Floyd Garcia played the piano and Chris Hubbard led the singing. A message giving tribute to the fathers was presented by Bro. Fred Thomas.

After prayer service, refreshments of punch and cookies were served.

The WMS also presented a Father's Day program at Crest View Lodge June 15. Everyone enjoyed the fellowship and the message.

Mr. and Mrs. O. C. Ashton's grandson, Dearl Gene Messick of Phoenix, Ariz. is spending the summer with them. Their daughter and husband, Mr. and Mrs. Bill Settle, Mr. and Mrs. Don Ashton and family from Lubbock came and put the roof on O. C.'s house for him, and had a nice visit.

Weather

June '72	Prec.	Hi	Lo
Mon. 14		95	72
Thur. 15	1.56	92	62
Fri. 16		87	66
Sat. 17		88	64
Sun. 18		92	68
Mon. 19		102	72
Tues. 20		103	72
Total precipitation to date:			
1971.....		9.26	
1972.....		5.80	

Voncille Messick And Rudy M. Martinez To Wed

Mr. and Mrs. Charley Messick of Rotan announce the engagement of their daughter, Voncille, to Rudy Michael Martinez, son of Mr. and Mrs. Rudolpy Martinez, Rotan.

The bride-elect will be a senior at Rotan High School in the fall.

The prospective bridegroom is a graduate of Hobbs High School and is employed at the National Gypsum Company.

Wedding will be August 5, at St. Joseph's Catholic Church.

Checks cost less than money orders and you don't have to go to the Post Office.

Citizens State Bank
Roby, Texas

Central Lumber & Supply Co.
Lumber And Building Supplies
New Construction And Re-Modeling

CUSTOM BUILT CABINETS
GAS & ELECTRIC WATER HEATERS
PRE-FINISHED PANELING
WESTINGHOUSE APPLIANCES
INSTALLATION AVAILABLE
PLUMBING SUPPLIES... PAINT

OPEN MON. - SAT. 776-2371 ROBY, TEXAS

HE'S SAFE!

Baseball is one of the few experiences of life in which you learn immediately and unquestionably whether you're safe—or out.

In other pursuits we can go on for years thinking we're safe when we're not.

Of course, in life as in baseball it is what a man attempts and decides to do, and how well he fulfills his aim, that determines whether he'll be safe. And in life, too, each venture calls for determination and a knowledge of the rules.

For many youngsters in our community the church is the sandlot of life. In the church's youth activities they find their training and experience—for one day on the "diamond" of life they'll be making decisions and pitting their strength against serious challenges, relying on the religious convictions and moral principles they gained on the way up.

In weighing your child's need of spiritual development remember this: In life, each day doesn't offer a new ball game!

CHURCH OF CHRIST Rotan, Texas Jerry Berry, Minister Bible Study - 9:45 a. m. Worship - 10:30	FIRST BAPTIST CHURCH Rotan, Texas Rev. Fred Thomas, Pastor Sunday School - 9:45 a. m. Worship - 10:56 a. m.	METHODIST CHURCH Longworth, Texas Newton Daniel, Pastor Sunday School - 10:00 a. m. Worship - 11:00 a. m.	CALVARY BAPTIST CHURCH Rotan, Texas Rev. Jack DeWitt, Pastor Sunday School - 10:00 a. m. Worship - 11:00 a. m.	ROBY CHURCH OF CHRIST Roby, Texas Wardell Halliburton, Minister Bible Class - 10:00 a. m. Worship - 11:00 a. m.	FIRST UNITED METHODIST McCauley, Texas Vernon Mayfield, Pastor Sunday School - 10:45 a. m. Worship - 9:45 a. m.
FIRST UNITED METHODIST Rotan, Texas Albert W. Cooper, Pastor Sunday School - 9:30 a. m. Worship - 10:30 a. m.	CHURCH OF NAZARENE Rotan, Texas H. D. Williams, Pastor Sunday School - 9:45 a. m. Worship - 10:40 a. m.	HIGHLAND HOME BAPTIST Rotan, Texas John Barnes, Pastor Sunday School - 10:00 a. m. Worship - 11:00 a. m.	SYLVESTER BAPTIST CHURCH Sylvester, Texas Sunday School - 10:00 a. m. Worship - 11:00 a. m. Sunday Night - 7:00 p. m.	FIRST UNITED METHODIST Sylvester, Texas Morning Worship - 9:45 a. m. Sunday School - 10:30 a. m. Monthly Prayer Meeting	ST. JOSEPH'S CATHOLIC Rotan, Texas John Hoorman Mass - Saturday evening 7:30 Mass - Sunday 9:00 a. m.
EMMANUEL BAPTIST CHURCH Rotan, Texas Sunday School - 10:00 a. m. Worship - 11:00 a. m.	LITTLE ZION BAPTIST Rotan, Texas Rev. W. B. Johnson, Pastor Sunday School - 9:45 a. m. Worship - 11:00 a. m.	ROTAN FORESQUARE CHURCH Eighth and Genevieve John Waldren, Pastor Sunday School - 10:00 a. m. Worship - 11:00 a. m.	EL PASO BAPTIST CHURCH South of Roby F. E. Healer, Pastor Sunday School - 10:00 a. m. Worship - 11:00 a. m.	PRIMITIVE BAPTIST CHURCH Roby, Texas Elder J. R. Knight Song Service - 10 a. m. - 4th Sun. Worship - 11:00 a. m. - 4th Sun.	McCAULEY BAPTIST McCauley, Texas Virgil Smith, Pastor Sunday School - 10:00 a. m. Worship - 11:00 a. m.
CROSS ROADS BAPTIST 6 miles SW of Rotan Rev. Ross Anderson, Pastor Sunday School - 10:00 a. m. Worship - 11:00 a. m.	FIRST UNITED METHODIST Roby, Texas Rev. S. Homer Salley, Pastor Sunday School - 10:00 a. m. Worship - 11:00 a. m.	HOBBS BAPTIST CHURCH Hobbs Community J. H. Skiles, Pastor Sunday School - 10:00 a. m. Worship - 11:00 a. m.	SARDIS BAPTIST CHURCH 2 miles SW of Rotan Rev. Bob Cameron, Pastor Sunday School - 10:00 a. m. Worship - 11:00 a. m.	FIRST ASSEMBLY OF GOD Rotan, Texas Rev. Earl Cravens Sunday School 10:00 Church 11:00 Night Services 5:00	CHURCH OF CHRIST Rotan Latin American Bible Class - 10:00 a. m. Worship - 11:00 a. m.

Weathersbee Funeral Home 735-2255	Central Lumber & Supply "One Call For All"	Martinez Dairy Milk Keeps You Slim & Trim	Roby Ins. Agency 776-2361
H.L. Davis & Co. "The Friendly Store"		Rotan Cotton Oil Mill 400 S. Cleveland - 735-2271	Crestview Lodge "Rotan's Newest Convalescent Home"
Noles Drug Roby 776-2431 - Roby	Farm Tractor & Service, Inc Your JOHN DEERE Dealer	Fisher County Nursing Home 735-3291	Rotan Insurance Agency JOE D. BURK - Agent
Rotan Paint & Body 735-3441 - Rotan	Clinic Pharmacy Complete Prescription Service	Billy Henderson	Roby Hydro Inc. Snyder Highway - 776-2240
Midwest Electric Roby "Owned by Those We Serve"	First National Bank Of Rotan Established in 1907	Bill & Gene T.V. Your Hometown Zenith Dealer	Bart Strayhorn 735-2231
Rotan Dept. Store 210 W. Snyder - Rotan	Atwell Cleaners Suits Made to Order	Hatahoe Drive Inn Home of Super-Size Hamburgers	Landes Furniture 735-3171
Home Lumber Co. RCA - G. E. - COLORIZER PAINTS	Citizens State Bank Member F. D. I. C.	Rotana Restaurant Steaks - Mexican Food - Sea Food	Calvins Grocery & Market 735-3112
Sweetwater Prod. Credit Farm and Ranch Loans	Fisher Co. Farm Bureau 735-3491		Farmers Union Coop. Gin 776-2237

Judy Scherwitz Is United With Paul Cotton

The Highland Heights Methodist Church, Sweetwater, was the setting at 7:00 p.m. June 17 for the marriage of Miss Judy Ann Scherwitz and Paul Mitchell Cotton.

The Rev. Ron Hamby led the couple in repeating double-ring vows.

Mrs. Darl Jones rendered nuptial selections and accompanied Miss Joyce Batteas as she sang "More" and "The Lords Prayer." Mrs. Jones and Mrs. Jerry Scherwitz played a duet to the Wedding March.

The bride is the daughter of Mr. and Mrs. R. H. Scherwitz of Roby, and the groom is the son of Mr. and Mrs. F. D. Cotton of Waco.

Given in marriage by her father, the bride chose a floor length gown of white organza lined with satin. A ruffle trim-

med with ribbon lace accented the bodice and hemline. Her chapel length veil was outlined with ribbon lace. She carried a bouquet of mixed flowers. A good luck penny worn in her shoe was a gift from Mrs. Walter Wittie of Gatesville.

The bride's matron of honor was Mrs. Bill King of Marshall, Ark. Bridesmaid was Mrs. Bobby Humberg of Waco, sister of the groom.

The attendants wore formal gowns of white and orchid ribbon lace lined with purple crepe. They wore orchid garden hats with orchid ribbon and carried white garden baskets of mixed flowers.

Best man was Ronnie Bink of Waco, Groomsman was Jerry Bailey of Stephenville.

Mrs. John Clark of Pecos registered guests.

Terry Scherwitz, brother of the bride, and Malea Scherwitz, cousin of the bride lit candles.

John David Scherwitz and Laura Jones were ring bearer and flower girl.

Jerry Scherwitz, brother of the bride and Mike Mulj of Waco seated guests.

Immediately following the wedding ceremony, a reception

was held in Fellowship Hall of the church.

The bride's table was laid with a white satin cloth covered with a double tiered ruffle net cloth trimmed in white satin ribbon. A silver candleabra centered the table. Low pewter bowls held mixed flower arrangements. Punch, cake, nuts and mints were served at the bride's table. The groom's table was also covered with a white satin cloth with white net, from which chocolate cake, coffee, mints, and nuts were served.

Serving for the reception were Mrs. Charles Stephens and Mrs. Jerry Bailey of Stephenville and Mrs. Jerry Scherwitz and Gay Nell McGinnis, of Roby.

The bride is a 1969 graduate of Roby High School and is a senior student at Tarleton State College. The groom, a 1967 graduate of Waco High School, is also a senior student at Tarleton State.

After a short wedding trip to New Mexico and Colorado, the couple will make their home in Stephenville where they will continue their studies.

Parents of the groom hosted the rehearsal dinner at Holiday Inn, Sweetwater.

Barbara Mitchell Enrolled At McMurry College

Barbara Ann Mitchell, daughter of Mr. and Mrs. Frank Mitchell of Roby, is amount the 641 students enrolled for the first summer semester at McMurry College in Abilene.

First term final examinations will be given July 7. Registration for the second McMurry summer semester will be July 6-7 and finals August 11.

Roby WMU News

Mrs. W. A. Hughetaught a Leadership Manual June 6, at Roby First Baptist Church.

June 13, a current mission program was given by Mrs. J. G. Washaw for the WMU.

A good attendance was at both meetings.

Calendar Club Plans Events

The Calendar Club will have a Hamburger Supper at 7:30 p. m. Saturday, June 24, in the home of Mr. and Mrs. John Gray. Co-hostesses will be Mrs. Garvis Hinson and Mrs. Herbert Moore.

Following the supper, games of volleyball will be played. Members are urged to attend.

Father's Day visitors in the home of Mr. and Mrs. B. K. Newhouse, Roby, were Mr. and Mrs. Bright Newhouse and Kim from Clarendon, who came for the boys who have been visiting and helping with the farm work for the past three weeks, and Mr. and Mrs. Don Newhouse of Abilene.

RENTAL HOUSING SURVEY

A rental housing project is being planned for this community. The project would provide comfortable living at reasonable rental rates. Your opinion on the following will help us to determine whether such a project is practical. This information does not obligate you in any way.

1. What age group are you in? 62 or over () 50-62 () Under 50 ()
2. Marital status: Married () Single Man () Single Woman ()
3. Number of persons in your household: ()
4. Annual income: Under \$3000 () \$3000-\$5000 () \$5000-\$6500 () \$6500-\$8000 () Over \$8000 ()
Does your income include: Old Age Assistance () Social Security () Veterans Pension () Other () If other, Specify _____
5. Do you own () or rent () present residence?
6. Do you live in House () Apartment () Room ()
On a farm () In town ()
7. Is your present housing modern () Not modern but adequate ()
Inadequate () If so, in what respect? _____
8. What arrangement do you prefer?
Efficiency apartment ()
One bedroom, kitchen, bath, living room ()
Two bedrooms, kitchen, bath, living room ()
Three bedrooms, kitchen, bath, living room ()
9. What amount of rent would you be willing to pay if rent included water, but not electricity and heat? \$ _____
10. Would you want to maintain own yard () Flower garden ()
11. Would you be willing to move in if apartment was available? _____
12. Name _____ Address _____

Card of Thanks

To former members of the Bethel Baptist Church, Fisher County.

We would like to take this means of thanking each and every one of you for the gift of money from your church. We appreciate your thoughtfulness and accept it with deep gratitude.

It is our desire that you feel free to visit and worship with us at any time.

May God's richest blessings be upon you.

Hobbs Baptist Church,
Rev. J. H. Skiles

Card of Thanks

We wish to take this means to express our sincere thanks and appreciation to everyone who helped in any way during the loss of our loved one. We wish to thank the ladies for bringing food and for serving. Our thanks to the people for sending the beautiful flowers. May God bless each of you.

The family of
Gaudalupo Soliz

Mr. and Mrs. Ronald Boyd of Gainesville, Mo. visited with her parents, Mr. and Mrs. J. P. Sexton and her brother Don, Rotan. Mrs. Boyd is the former Carol Sexton.



Insurance Doesn't Cost... It Pays



Call 735-3491 or See
Ben Reaid
Representing
Farm Bureau Ins.
215 W. Snyder-Rotan

If you get a wrong distance number, we'll make it right!

If you dial a Long Distance call direct and get a wrong number, simply hang up and dial the operator immediately. She'll see that you don't get charged for a wrong number. It's our way of avoiding "hang-ups" in your One-Plus dialing service.

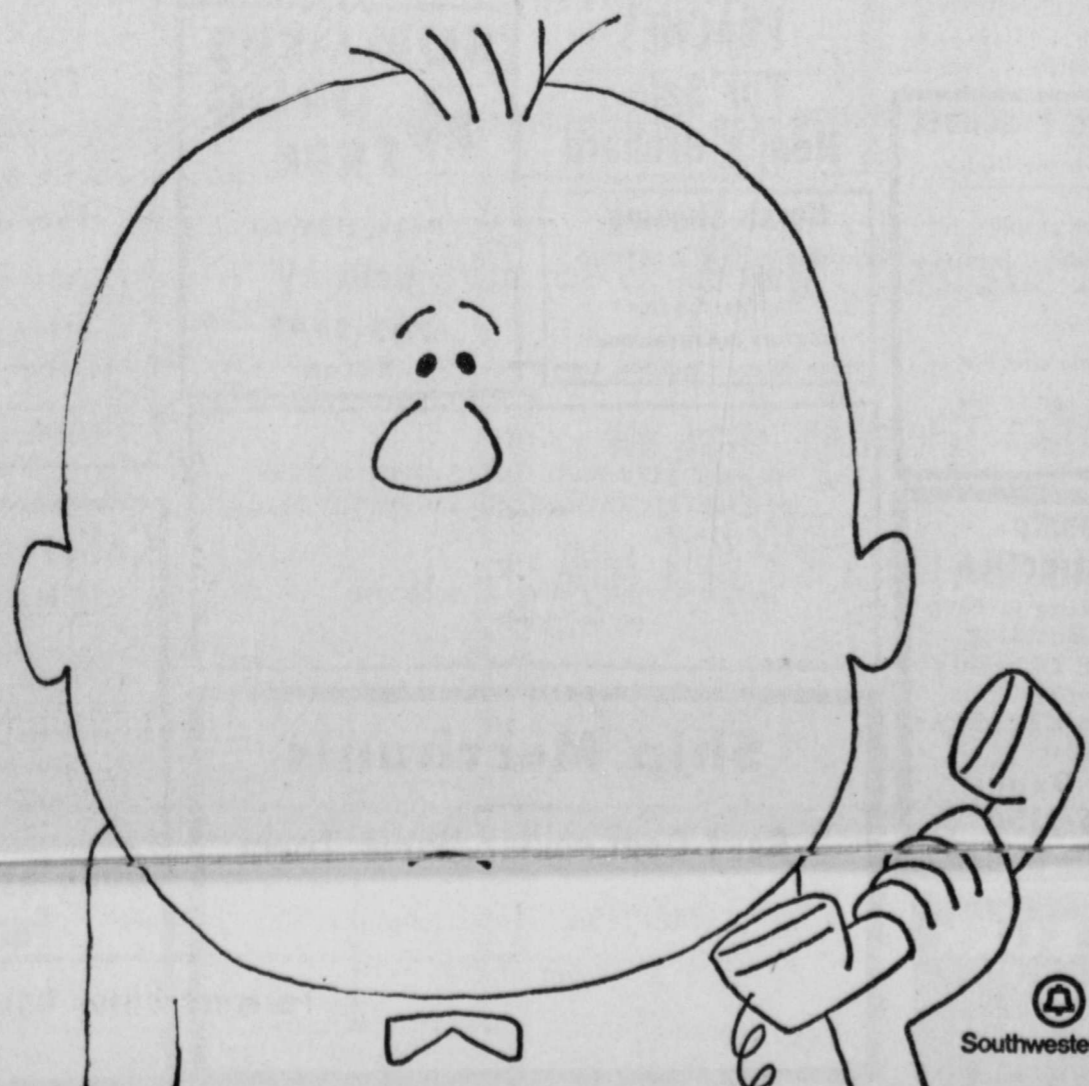

Southwestern Bell

HAYES

GROCERY & MARKET

SPECIALS
JUNE 22-24

CANNED COOKIES 12 oz. **11¢** 10¢ **11¢** 10¢

ROUND STEAK \$1.09 1.09 **1.09** 1.09

PACE GOLD CROWN BACON 75¢ 75 **75** 75

PORK STEAK 69¢ 69 **69** 69

NABISCO TOASTETTES 39¢ 39 **39** 39

DEL MONTE SWEET PEAS 4 FOR 99¢ 4 FOR 99 **4 FOR 99** 4 FOR 99

DEL MONTE GREEN BEANS 4 FOR 99¢ 4 FOR 99 **4 FOR 99** 4 FOR 99

PINEAPPLE JUICE 46oz. 3 FOR 99¢ 3 FOR 99 **3 FOR 99** 3 FOR 99

DEL MONTE PINEAPPLE #211 MIX OR MATCH 5 FOR 99¢ 5 FOR 99 **5 FOR 99** 5 FOR 99

DEL MONTE FRUIT COCKTAIL 303 4 FOR 99¢ 4 FOR 99 **4 FOR 99** 4 FOR 99

3 BAR BATH WITH FREE TOWEL **DOVE SOAP** 69¢ 69 **69** 69

DEL MONTE WHOLE GREEN BEANS 4 FOR 99¢ 4 FOR 99 **4 FOR 99** 4 FOR 99

DEL MONTE SAUERKRAUT 5 FOR 99¢ 5 FOR 99 **5 FOR 99** 5 FOR 99

DELICIOUS APPLES 23¢ 23 **23** 23

LEMONS 6¢ 6 **6** 6

ORANGES 15¢ 15 **15** 15

CANTALOUPE 3 FOR 1.00 3 FOR 1.00 **3 FOR 1.00** 3 FOR 1.00

On Sale This Week

FOR HER

Family Circle COOKING



Vol. 849

FOR HIM

The Family Handyman Do-it-Yourself Encyclopedia



Vick Burk Attends WTU Sponsored Symposium

Twenty-two outstanding students and teachers from the area served by West Texas Utilities Company attended the 12th Annual Nuclear Science Symposium at the University of Texas at Austin. The conference got underway Monday, June 5th and ended Thursday, June 8th.

Vick Burk, Rotan High School student, was among those attending from this area.

The symposium was jointly sponsored by the Texas Atomic Energy Research Foundation and

the University of Texas. West Texas Utilities is one of the sponsoring companies for TAERE.

The 500 selected high school science students and teachers who attended the session were offered the rare opportunity of hearing lectures by some of the nation's outstanding nuclear scientists.

The foundation was formed for the primary purpose of conducting the world's first and largest privately financed research effort in the field of nuclear en-

ergy. Currently, the Foundation and General Dynamics Corporation are jointly sponsoring a program in nuclear fusion research aimed at controlling thermonuclear reactions for the production of electric power. Fusion is the energy process of the sun and the stars.

The goal of the Foundation and WTU is not research alone, but to also assist in the advancement of the knowledge of nuclear science in Texas schools. Of special interest to the spon-

sors is bringing to students and teachers a realization of the privileges, responsibilities and opportunities which scientific discoveries in the field of nuclear energy presents.

There are over 1,000 accredited senior high schools in the state of Texas. Rotan can be justly proud of his high school for having been chosen by the University of Texas as one of the 150 high schools in the state invited to send a student and a teacher to the Symposium.



12TH ANNUAL NUCLEAR SCIENCE SYMPOSIUM AT UNIVERSITY OF TEXAS AT AUSTIN. Left to right, Bill Tedder, West Texas Utilities Representative; Vic Burk, Rotan High School Student; and Joel Wilson, West Texas Utilities Representative. Vic was awarded the honor of representing Rotan and Fisher County at the Symposium held in Austin recently.

Mr And Mrs Hollabaugh Have 50th Anniversary

Mr. and Mrs. Orville Otto Hollabaugh marked their Golden Wedding Anniversary, June 4, and to help them celebrate the occasion were their children and grandchildren.

The Hollabaughs spent most of their married life in Roby, where he is engaged in farming and ranching, and served as Fisher County Deputy Sheriff for a number of years. He was also an active member of the Fisher County Sheriff's posse.

Mrs. Hollabaugh's parents and the parents of her husband were

early day pioneers, settling here in the 1900's.

Children and grandchildren present for the occasion were Mrs. Aza Lee Baxter and Brad of Savannah, Ga., Mr. and Mrs. D. K. Kelly of Lampasas Wayland Kelly of Austin, Connie Kelly of Abilene, Dr. and Mrs. Charles Hollabaugh of Pittsburg, Pa., Mr. and Mrs. Stephen Hollabaugh, Phil and Wayne of Abilene, Mr. and Mrs. W.L. Hooper, Loyd and Nance of Nacogdoches. Unable to attend were Laura of Savannah, Ga., and 4 other grandchildren.

Frances Wicker Named Head Of Abilene TARS

Frances Lee Wicker, daughter of Mr. and Mrs. William Wicker of Abilene and granddaughter of Mr. and Mrs. W.F. Wicker of Rotan was recently installed as president of the Abilene TARS Chapter.

TARS (Teens Aid the Retarded) is a nationwide volunteer youth group which was first organized six years ago in Dallas when a small handfull of young people went to Bob Gooding, a TV and Radio personality, and ask him to be their sponsor.

The Texas TARS have grown to more than 6000 members in some 63 chapters throughout the state.

Frances has been an active member of the Abilene Chapter almost from its very beginning by working hard to further their goals of working with the mentally retarded, encouraging the young people to seek careers in the field, serve in the program of community awareness, and other service programs.

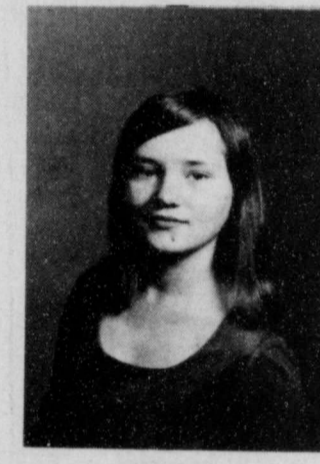

Frances Wicker

According to Mrs. Archie Petty, Abilene TARS Advisor, the TARS unit will be involved in a recreational program this summer for the retarded children in this area. Sixteen delegate members will also be attending the annual Texas State Convention in Houston, June 30 through July 2. Then the second week of July many of the TARS will serve as counselors at Camp Roadrunner, the summer camp for mentally retarded boys and girls of Region III, Texas Association for Retarded Children Inc.

Out of town relatives in Roby to attend funeral service for Bill Edwards were: Mr. and Mrs. Jim Turnbull, and G. W. Finch from San Angelo; Mr. and Mrs. Lee Everheart, Mrs. Glenn Avants, Mr. and Mrs. Garland Finch, Mrs. Earl Houston, Lamesa; Mrs. E. C. McWhirter, Pearl and Mrs. D. F. Hanes, Tahoka; Mrs. Charlie Leki and Mrs. Joe White of Lubbock; Mrs. Elmer Gilbert and Mrs. Ernest Gilbert, Roscoe; Mr. and Mrs. Leonard McCombs, Lois McCombs, Mr. and Mrs. J. C. McCullough, Mr. and Mrs. Dave Klepper, Mr. and Mrs. Geo. McBeth, and Mr. and Mrs. Lester Greenway and children, Rotan; Mr. and Mrs. Weldon Bennett of Sweetwater, and Dr. and Mrs. Marshall Turnbull, Abilene.

Bro. A. A. Watson, retired minister of Abilene, held the services at Highland Home Baptist Church last Sunday. He and Mrs. Watson had lunch in the home of Mr. and Mrs. Bobby Smith, Bro. and Mrs. Watson are former residents of Rotan.

Mr. and Mrs. B. K. Newhouse, Roby, visited with his sister, Ester Mahaffey in Richland Springs recently. Mrs. Cora Newhouse of Abilene accompanied them.

Mr. and Mrs. Ott Nolen, Rotan, recently spent a week in Uvalde with their daughter, Mr. and Mrs. Claude Thompson and sons. While in Uvalde, they enjoyed the annual Uvalde A-Rama Festival and World's Championship Cow Country Cookout. Highlight of the Festival was the parade with Governor-elect, Dolph Briscoe and his family as parade marshalls. Other dignitaries in the parade were Congressman O. C. Fisher, State Senator Pete Snelson; Representative James Nugent; Uvalde Mayor, Pete Knowles; writer H. Allen Smith of New York, and Hollywood's Slim Pickens and Big John Hamilton.

The Nolen's also enjoyed a fishing outing on the Leona River with a good catch.

Mr. and Mrs. Sam Hamm of Rotan visited Mr. and Mrs. Foy Acker in Tulla last weekend.

Mr. and Mrs. Roger Smith of Rotan visited in Austin and Marble Falls last week. Miss Dan Robinson Sally and Robie spent last weekend with Mr. and Mrs. Smith. The grandchildren will stay another week.

Miss Jo Ann Shows had three paintings in the Art Guild Show in Chicago recently. Her paintings won a prize and had high rating. Miss Shows is the daughter of Mr. and Mrs. R. D. Shows of Rotan. She teaches 6th grade in the Chicago public schools.

Deborah Frazier And Billy Brown Repeat Wedding Vows

Mr. and Mrs. David Fenton Brown are at home in Roby following their marriage at 8 p.m. June 9 in the chapel of First Baptist Church in Roscoe.

The Rev. Charles Bush led the couple in repeating double-ring vows.

The bride is the former Deborah LaFae Frazier, daughter of Mr. and Mrs. Billy Wayne Frazier of Roscoe and Mr. and Mrs. Oddis Brown of Roby are parents of the bridegroom.

Mrs. Herbert Williams, pianist, rendered nuptial selections including "More", "Love Theme from Romeo and Juliet", "Somewhere My Love" and "Let It Be Me".

Given in marriage by her father, the bride wore a white crepe double knit gown fashioned with a scalloped neckline, bell sleeves and A-line skirt. Seed pearls trimmed the gown. Her veil of silk illusion fell from a headpiece of matching fabric roses dotted with seed pearls.

She carried a cascade arrangement of white orchids and rosebuds topping a white Bible.

The bride's maid of honor

was her sister, Tonya Frazier, she wore an orchid gown of crepe polyester double knit.

Her headpiece was matching fabric roses and she carried a white basket filled with deep purple flower petals.

Guests were seated by Gaylord Frazier of Merkel, cousin of the bride and Gary Carson of Lubbock, cousin of the bridegroom.

Best man to the groom was his brother, Jay, of Lubbock.

Immediately following the wedding ceremony a reception

was held in Fellowship Hall of the church.

When the couple left for a wedding trip to San Angelo, the bride was wearing a pastel yellow chiffon frock. Her accessories were yellow and she wore an orchid corsage.

The bride, a graduate of Roscoe High School, has completed two years of study at Texas Tech University.

The groom, a graduate of Roby High School, has completed three years of studies at Texas Tech.

Card of Thanks

Words cannot express our sincere and heart-felt thanks for the many acts of kindness and consideration, show to us in the loss of our beloved, husband, father, and grandfather. With humble thanks, our hearts go out to all who helped in any way. For the good food, to those who served, the cards and words of sympathy, the beautiful floral offerings, the consoling service brought by Bro. Charles Whitlock to the choir and pianist for the lovely songs, to the personnel at Golden Haven Home for your concern and good care given him during his stay there, thank you from the bottom of our hearts, and may God bless each of you.

The family of Bill Edwards

Mr. and Mrs. Worth Smith of Rotan visited Mr. and Mrs. Hill G. Smith recently and attended the graduation exercises of their grandson, Mike Smith from Lewisville High School. He will enter North Texas at Denton in the fall, where he will be studying engineering. Mike is employed by his Dad for the summer at Flexible Systems Inc., Interior building specialists of Dallas. Brad Smith is spending the summer with his grandparents, Mr. and Mrs. Worth Smith.

Visiting Mr. and Mrs. Douglas Eaton last weekend were their son and his family, Carol Ray, Patsy, Jimmy Lee and Tereasa and Windell Ray of De Leon. He is still in the Service, stationed at Kingsville. Also, visiting Mr. and Mrs. Eaton were their other son, J. C. and Pearl, John, James Lynn, Jeranie from Knox City; Phillip Vivian, and Tamy Lee and Robbin Joplin of Rotan; Roy, Ella Fay, Roy Allen and Regina Eaton of Roby, Friday night of last week Mr. and Mrs. John Haynes of Alamogordo, N. M., sister of Mrs. Eaton, spent the night with them.

Funeral Topic of Center HDC

Mrs. Ben Neepser of Roby was hostess Tuesday, June 13, when Center Home Demonstration Club met in the Willie Wired Hand room at Mid-West Electric.

Fay Anderson, president, called the meeting to order, and Mrs. Nina Cave read the minutes of the last meeting, in the absence of the Secretary, Mrs. Moore.

Mrs. Lowell Thornburg presented the program, "Planning and Financing Funerals", which was educational and informative.

Mrs. Joyce Noles, County T. H. D. A. Chairman, was elected delegate to the state convention.

Refreshments of fruit-pid and whipped cream was served to the members and two visitors.

Jeff Robertson, Floydada, spent the weekend with Mr. and Mrs. R. D. Shows, Rotan.

Card of Thanks

I wish to thank everyone that sent cards and flowers while I was confined to the hospital in Abilene. I can assure you that they were all very nice and I really appreciate your concern. Thanks very much.

Mrs. Jewel McSpadden

Hatahoe Drive In

For Sale

WE WILL HAVE ALL GULF OILS AND GREASES FOR SALE.

NED'S FUEL SERVICE

Located in
ROLLANS FARM SUPPLY BUILDING

735-3378 211 N. Cleveland

Supper Movie Menu

TIGER Drive In : 2 GREAT HITS
WED - TUES : DIRTY HARRY
THE WILD BUNCH

CINEMA 1. - MARY, QUEEN OF SCOTS
7:00 & 9:30

CINEMA 2. - BEWARE THE BLOB
7:25 & 9:10

PREECE

FRUIT AND VEGETABLE

POTATOES 10 LBS	49¢
RED DELICIOUS APPLES 25¢ LB.	RADISHES 10¢ PKG.
BANANAS 2 LBS 25¢	WE APPRECIATE YOUR BUSINESS
WHITE ONIONS 15¢ LB.	AVOCADOS 29¢ EA.
SQUASH 15¢ LB.	LETTUCE 25¢ LB.
TOMATOES	29¢ LB.

CARPET!

We Have A Good Supply Of Fine Quality Carpet At Reasonable Prices.

Professional Carpet Installers Offer Guaranteed Satisfaction

See Us For All Your Carpet Needs.

LANDES FURNITURE

rotan, Texas

Step up to the good life... with a

FRIGIDAIRE FOOD FREEZER

- Saves more than just food!
- SAVE work
- SAVE last minute shopping trips
- SAVE money
- Select yours from West Texas Utilities, now.
- Buy on Reddy Credit*

*Ask for details at WTU

West Texas Utilities Company Equal Opportunity Employer an investor owned company



AFFILIATED

Pack-a-Picnic SALE!

THRIFTWAY... a BETTER WAY to SAVE!

PRICES EFFECTIVE JUNE 19 THRU 24, 1972. WE RESERVE THE RIGHT TO LIMIT QUANTITIES THREE DAYS ONLY

WILSON'S CERTIFIED

SLICED BACON
79¢
1-LB. PKG.

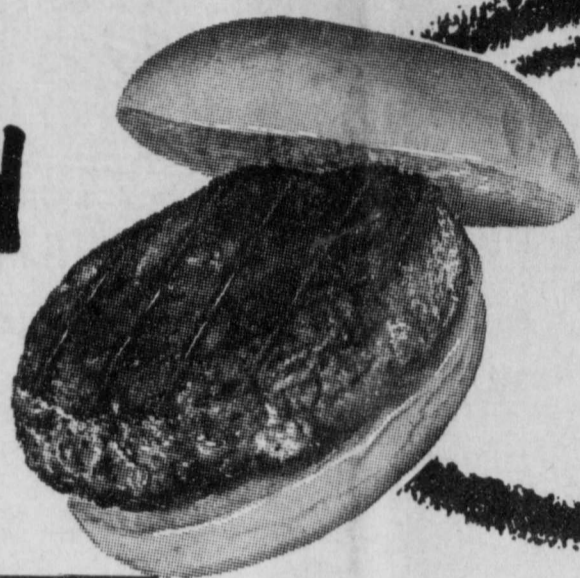

FRESH...EXTRA LEAN
GROUND BEEF
59¢
LB.



KRAFT
B.B.Q. SAUCE
18-oz. BTL. **39¢**

TENDERCRUST
HAMBURGER BUNS
CLUSTER PAK PKG. OF 8
29¢

**T
H
R
I
F
T
W
A
Y**

U.S.D.A. Graded Whole

FRYERS Lb. **29¢**



12 OZ. CAN

6 for
COKES 69¢



MC 2
BLEACH
19¢
GALLON

FIRST ONE WITH \$5.00 PURCHASE OR MORE EXCLUDING CIGARETTES

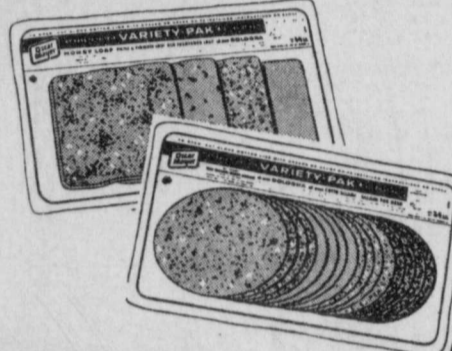

ROUND OR SQUARE
OSCAR MAYER
VARIETY PACK
LUNCH MEAT 12-oz. PKG. **99¢**

OSCAR MAYER
ALL MEAT SLICED
BOLOGNA 12-oz. PKG. **79¢**

OSCAR MAYER
PURE BEEF SLICED
BOLOGNA 12-oz. PKG. **79¢**

Gandys 1/2 Gal
COUNTRY FRESH
ICE CREAM 59¢

KRAFT 16 OZ.
FRENCH DRESSING 59¢

THRIFTWAY PRODUCE

CALIFORNIA CANTALOUPE Lb. **12 1/2¢**

COLORADO MOUNTAIN GROWN FRESH
GREEN ONIONS or RADISHES LARGE BUNCH **9¢**
YELLOW ONIONS Lb. **9¢**

SHURFINE-ASST'D. FLAVORS'
NON-RETURNABLE
DRINKS 28-oz. BTL. **4 89¢**

MORTON FROZEN
FRUIT PIES APPLE PEACH CHERRY 20-oz. PIES **2 79¢**

Special Good For 3 Days Only THUR.-FRI.-SAT.

On Sale This Week

FOR HER: Family Circle COOKING Volume 8 \$1.69

FOR HIM: The Family Handyman Do-it-Yourself Encyclopedia Volume 8 \$1.69

MENNEN PUSH BUTTON
SPRAY DEODORANT 4-oz. CAN **79¢**

MENNEN SOF-STROKE
SHAVE CREAM 11-oz. CAN **89¢**



QUART
MIRACLE WHIP **59¢**

LINDSAY PITTED LARGE
RIPE OLIVES 300 CAN **49¢**

SHURFINE 7 OZ.
SPRAY DEODORANT **59¢**

Make Delicious Mouth-Watering JAM or JELLY in minutes

with **PEN-JEL**

only 2 1/2-oz. 2/39¢

High Seas Conditioning After Shave

Conditions and protects your face

only 4-oz. \$1.39

31 GALLON SIZE
TRASH CAN **4 89¢**

SMACKERS 18 OZ.
PEACH BUTTER **59¢**

HUNT'S 300
TOMATOES 4 FOR **89¢**

LOW SUDSING DETERGENT
ALL 30¢ OFF LABEL JUMBO BOX **\$1.99**



KLEENEX DESIGNER TOWELS 3 JUMBO ROLLS \$1.00	MARYLAND CLUB COFFEE 1-LB. CAN 89¢	MARYLAND CLUB COFFEE 2-LB. CAN \$1.77
Ellis 2 1/2 Can JUMBO TAMALES 2 for 77¢	AMERICAN BEAUTY ELBO-RONI POLY BAG 10-oz. PKGS. 49¢	LUCKY LEAF APPLE JUICE QUART BOTTLE 39¢
ALABAMA GIRL HAMBURGER DILL PICKLES 32-oz. JAR 49¢	SUNSHINE VANILLA WAFERS 3 11-oz. PKGS. \$1.00	FRENCH BROWN GRAVY MIX 1-oz. PKG. 19¢
FRENCH'S SLOPPY JOE MIX 1 1/2-oz. PKG. 19¢	FRENCH'S SPAGHETTI SAUCE MIX 1 1/2-oz. PKG. 19¢	EXCEDRIN TABLETS 36's 69¢
CUTEX OILY POLISH REMOVER 3-oz. BTL. 29¢	MISS BRECK HAIR SPRAY 13-oz. CAN 89¢	CLEANING TABLETS POLIDENT 15's 49¢

FINAL TOUCH
FABRIC SOFTENER
10" OFF LABEL 33-oz. **69¢**

DOVE
LIQUID DETERGENT
10" OFF LABEL 22-oz. **49¢**

VALUABLE COUPON
Gladiola
5 lb. Bag **39¢**
Coupon valid June 22 - 24th Redeemable only at Thriftway

Glen's Thriftway
Gold Bond Stamps
DOUBLE ON WEDNESDAY
735-3381
SPECIALS 3 DAYS ONLY
THURSDAY, FRIDAY, AND SATURDAY
WATCH FOR OUR CIRCULAR MONDAY

VALUABLE COUPON
40" IN-AD COUPON NO. 15
MARYLAND CLUB
INSTANT COFFEE
6-oz. JAR WITH COUPON **98¢**
Redeemable only at Thriftway Coupon good June 22 - 24th