

# Texas Litter Costs Texans Big Money

Recent research conducted on behalf of the State Department of Highways and Public Transportation indicated an estimated half billion pieces of trash along Texas roadways in late August.

Four different studies were commissioned by DHT in advance of a major effort to reduce roadside litter which cost taxpayers a whopping \$20 million last year.

The Institute for Applied Research, headquartered in Sacramento, California, performed a visible litter count in key locations throughout the

state. The Institute, who has performed more than 40 studies on litter throughout the United States, is considered the premiere firm in the nation on litter research. This study indicated that roadside trash is approaching an estimated half billion pieces.

Their other findings included: Fifty-three percent of highway litter is caused by deliberate acts, while 47 percent involves loss of truck loads that were unsecured or uncovered, as well as miscellaneous items blowing out of trucks.

Sixty-one percent of roadside litter can be found in urban areas. The remaining 39 percent lies on rural freeways and roads.

Litter from automobiles accounts for 30 percent of all roadside litter.

Pickup trucks are the source of a disproportionate amount of roadside litter, amounting to 27 percent. However, pickups represented only 11 percent of all vehicles observed.

Stake, flatbed, dump trucks and trailers account for 21 percent of roadside litter in Texas.

Other vehicles contributed the

remainder.

As to who litters, "habitual" litterers in Texas were defined in a separate study by the Institute as primarily males, between the ages of 10 and 44. The largest category was young men, between the ages of 18 and 34. The study indicated that 71.4 percent of all deliberate littering is done by males, with females representing only 28.7 percent.

Decision Analysts, Inc., of Arlington performed two studies to probe why Texans litter and their awareness of litter as a statewide

problem.

As to why Texans litter; convenience is the primary reason.

Most Texans interviewed do not approve of littering, but 43 percent admitted to littering from time to time. Less than 21 percent were able to correctly estimate the tax dollars required to clean up Texas roadways.

"The State Department of Highways and Public Transportation will use the research statistics to implement a three-pronged program aimed at significantly reducing lit-

ter," said J. Don Clark, director of the Highway Department's Information Services Section.

This war against trash will include an aggressive, targeted media campaign directed at habitual litterers, a state-wide community-by-community clean-up and beautification program and incentives for increased law enforcement.

The \$20 million spent by the State last year on litter collection does not include tax dollars spent by city and county governments on local clean up efforts.



**NICHOLS' WORTH**

By: Nanalee Nichols

With farming in the desperate state it is currently in, and with making a living at it very difficult, this column, printed in the Crosbyton, Texas, News, was brought in by a friend who thought it might bring a smile or two to farmers everywhere.

Last Will and Testament of a Farmer:

I leave: To my wife...My overdraft at the bank. Maybe she can explain it.

To my son...Equity on my car. Now he'll have to go to work to meet the payments.

To my banker...My soul. He's got a mortgage on it anyway.

To F.H.A....My unpaid bills. They took some real chances on me and I want to do the same for them.

To A.S.C.S....my grain bin. I was planning to let them have it next year anyhow.

To S.C.S....My farm plan. Maybe they can understand it, I never did.

To the junkman...my equipment...he's had his eyes on it for years.

To my undertaker...a special request: six implement and fertilizer dealers for pallbearers. They're used to carrying me.

To the weatherman...rain, sleet and snow for the funeral. There's no use having nice weather now!

To the gravedigger...Don't bother. The hole I'm in already should be big enough.

And last: put on my monument...Here lies a farmer who has now assumed all his obligations."

## PEOPLE AND THINGS

The BOGATA V.F.W. will hold their REGULAR MEETING Monday, Dec. 9 at 7 p.m. in the V.F.W. Building.....

COMMODITIES will be distributed at the Bogata UNITED METHODIST CHURCH December 10, Tuesday, beginning at 9 a.m.....

The Talco-Bogata C.I.S.D. TAX OFFICE will be CLOSED December 24 and 25 and January 1. The office will be OPEN December 23, 26, 27, 30 and 31 from 9 a.m. to 3 p.m. The office will resume REGULAR DAYS Monday through Friday, and regular hours 8 a.m. to 4 p.m. on January 2.....

REMEMBER...don't WAIT til the LAST MINUTE to renew your paper...do it now, while it's on SALE...NEW SUBSCRIBERS can take off \$4...renewals \$2....

## Editor's Quote Book

It is better to have a hen tomorrow than an egg today.  
Thomas Fuller

## The Talco Times

USPS 532-900  
Published Every Thursday  
P.O. Box 157, Talco, TX 75487  
Entered as Second Class Matter At Depart. Texas 75433  
Nanalee Nichols Publisher-Editor  
Thomas Nichols Managing Editor  
Mrs. Wayman Alexander-Talco News Editor  
SUBSCRIPTIONS  
\$10.00 A Year For Red River, Lamar and Titus Counties  
\$12.50 A Year For Out of Above Counties And In State of Texas.  
\$15.00 A Year For Out-Of-State.  
DEADLINE  
For News and Advertising, Tuesday At Noon.  
Postmaster send change of address to:  
Nanalee Nichols  
P.O. Box 306  
Bogata, TX 75417

# The Talco Times

50th YEAR, No. 44

TALCO, TITUS COUNTY, TEXAS

Thursday, December 5, 1985

25 Cents



THE RIVERCREST FFA won first place in the Bogata Christmas Parade Tuesday afternoon with this entry. (Staff Photo by Diana Eudy)



THE RIVERCREST SENIORS captured second place at the Bogata Christmas Parade which was held Tuesday afternoon. (Staff Photo by Diana Eudy)



CITY OF TALCO can be proud of the 1976 750 Ford 12-ton chassis yellow firetruck purchased from the Firemaster Fire Apparatus at Springfield, MO. The truck replaced a 1956 model Ford because of in-

urance limitations placed on 30 year old fire equipment. The later model truck will improve the Talco insurance key rates. All donations will be used to buy

equipment. Pictured with the truck are Fire Chief, Randy Carroll and Marvin Owings, head of Talco's Water Department. (Staff Photo)

## Rebs Take AAAA Sulphur Springs

The Rivercrest Rebels got their first win of the young season last Tuesday night against the Sulphur Springs Wildcats.

The game was close throughout with the Rebels pulling away during the third and fourth periods.

Tony Jasso was back for the Rebels after missing the first two games with an injury he received in football. "We are proud to have Tony back and it looks like he will be full speed soon," said Coach Wake Wood.

All Rebels contributed to the win

with Charlie Martin scoring 18 points with 10 rebounds. Chris Anderson had 15 points, Brad Anderson had 13 points and Russell Rozell scored six points and had 12 rebounds. Tony Jasso and Bradley Woods each had good floor and defensive games. The Rebels were able to play all of the players during the game.

"We are real proud of the Rebels' play at this point in the season. We have just got to work hard to continue to improve," stated Coach Wood.

## Rivercrest Tourney Has Strong Field

The annual Rivercrest Invitational Tourney will start today, Thursday, at the Rivercrest and Talco gyms.

In the girls' division, West Lamar-Delmar will be the favorite to take the tourney crown. All other teams will be strong. Detroit, Rivercrest, Prairiland, North Lamar, Cooper and Roxton will all field strong teams. Sabine girls have dropped out of the tournament because of travel problems and the Rivercrest JV will take their place.

In the boys' division there is no clear cut favorite. Rivercrest has drawn a bye in the first game. Roxton will play Cooper, Prairiland plays Detroit and West Lamar-Delmar plays North Lamar.

Rivercrest will play the winner of the Cooper-Roxton game Friday night in the nightcap. Cooper defeated Rivercrest in area play last year 49-45

and advanced to the regional finals before they were defeated by the eventual state champion, Grapeland.

Cooper has a very strong team and is definitely a strong contender for the tourney championship.

In the opposite bracket, Prairiland and West Lamar-Delmar will probably meet in the semi-finals Friday night with the winner advancing to the finals Saturday night.

"We had a very successful tournament last year. Our crowds were excellent and our games were very close and competitive. We feel we have the best tournament around and invite everyone out for the games," said Rebel Coach Wake Wood.

Admission will be \$1.00 for students and \$2.00 for adults Thursday and Friday. Saturday's games will be \$2.50 for all tickets.

## Talco VFD To Hold Second Shoot

The Talco Volunteer Fire Department will hold a second Turkey Shoot on Sunday, December 15 from 1 to 5 p.m. The cost for shooting will be \$2.50 per round. The shoot will be at the Talco football field at the Talco School. There will be several categories to choose from: Shotgun Skeet, Shotgun Still Targets, Pistol Targets, .22 Rifle Targets, Women's Pistol Targets and a Women's .22 Rifle Target. There will be no ammunition furnished at the shoot site.

All proceeds from the Turkey Shoot and the raffle go to the purchase of equipment for the fire department.

Everyone in the area is invited to attend and to try their luck at winning a turkey. Also come out and support the Talco Volunteer Fire Department.

The winners of the November Turkey Shoot were on Shotgun Skeet: Steve Hall, David Rozell, Dan Madden, James Crawford, J.R. Cox, Harlis Gibson, Randy Nolen, Randy Carroll and Johnny Taylor. Those winning in the shotgun target were Harold Wilbanks, and Mike Sloan. Those winning in the rifle and pistol categories were Frank Durham, Mona Pitts, Tom Jackson and Craig Ingram.

## Immunization Clinic Set For Bogata

The Texas Department of Health, Public Health Region 7/10 office announced plans today for the continuation of a series of monthly immunization clinics for all children needing immunizations.

The clinic will be conducted at the Bogata City Hall in Bogata on December 12 from 2 to 4 p.m. Future clinic dates will be announced.

The Health Department emphasized that this clinic is available to all children, preschool and school age, beginning at two months of age. Im-

munizations to be offered include Mumps, Measles, Rubella, Oral Polio, Diphtheria-Tetanus-Pertussis and Tetanus-diphtheria. All children must

be accompanied by a parent or legal guardian. Parents are reminded to bring the child's immunization record if it is available.

The Tetanus-diphtheria vaccine is available to adults.



**START YOUR HOLIDAY ADVERTISING EARLY!**



# Fulbright News

**By Betty Rodgers**  
William Earl Stevens and son Todd visited his father, Hurley Stevens and Mr. and Mrs. Clovis VanDeaver during the holidays.  
Visiting Ruby Chandler was Karen Baker of Dallas and Diane Woods of The Colony.

Mr. and Mrs. Otis Massey had lunch Thursday with Mr. and Mrs. Johnny Kelly in Paris.  
Visiting Mr. and Mrs. Worth Baker on Thursday were their daughter, Karen Baker, Mrs. Fannie Gullion of Dallas, Mr. and Mrs. Lee Little of Mesquite and Diane Woods of The Colony.

Mr. and Mrs. Hub Huneke of Hooks have been visitors of Mrs. Ethel Hill, Mrs. Violet Marcum came Thanksgiving day and spent through Sunday with her.  
Arthur Fisher and Anita visited Mr. and Mrs. Freddie Furr in Mt. Pleasant during Thanksgiving.  
Mr. and Mrs. Otis Massey were in Lone Star this weekend visiting Mr. and Mrs. Charles Guest.

Mr. and Mrs. Worth Baker and Karen visited Mrs. Ruby Baker in Paris Thursday. They visited the Virgil McFaddens, Mrs. Winnie Conway, Mr. and Mrs. Charles Conway and children Saturday night in Paris.  
Mr. and Mrs. Travis King had lunch Thursday in the home of their daughter, Mr. and Mrs. Randy Osburn in Paris.

Mr. and Mrs. Bobby Cremeen and their son and wife, Mr. and Mrs. Russel Cremeen of Ft. Worth visited this weekend.  
Children of Mr. and Mrs. Gary Pirtle of Paris visited their grandparents, Mr. and Mrs. Clovis VanDeaver this week.

Visiting Mr. and Mrs. Richard Gandy were Mrs. Sharon Atterberry of Euless, Mrs. Bob Embrey, Mr. and Mrs. Stacy Embrey, Sandy Gandy of Dallas, Worth Baker and Melissa Rodgers.

Mr. and Mrs. Bill Reddell of Mineral Wells, Mrs. Jack Kenner of Odessa, Mr. and Mrs. Porter Ridens of Denton were recent visitors of their mother, Mrs. Stella Ridens.  
Mr. and Mrs. Stacy Embrey had Thanksgiving dinner with her parents, Mr. and Mrs. Skidmore of Sulphur Bluff.

Ray and Jim Embrey of Dallas visited Mr. and Mrs. Bob Embrey Saturday.

# Cunningham News

**By Berniece Wyatt**  
Sympathy is extended to the family of Odis Aubrey. Funeral services were at the United Pentecost Church and he was buried here Friday.

Barton Lynn, Virginia Perkins, Mr. and Mrs. Paul Sauer of St. Petersburg, FLA and Ruby Douglas of Shawnee, OK spent Thanksgiving week with Berniece Wyatt.

Mrs. Tommie Denison was admitted to McCuiston Hospital Saturday night.

Mr. and Mrs. Max Floyd of Kansas City, MO spent Thanksgiving holidays with Mr. and Mrs. Roy Powers.

Mr. and Mrs. Tommy Presley and family with Mr. and Mrs. Lynn Golden of Clarksville and Mr. and Mrs. D.W. Webster of Calvin, OK spent Thanksgiving with Mr. and Mrs. Orel Bennett of Ft. Towson, OK.

A special invitation is extended to everyone to attend revival services conducted by Rev. Johnny Bell of San Antonio, beginning Wednesday night at Life Tabernacle Church.

Mr. and Mrs. Charles Taylor and Sherry Emory of Paris, Mr. and Mrs. Johnny Hall of Clarksville, Mr. and Mrs. George Struve and Sarah of Mesquite and Mr. and Mrs. Clyde Slusher had Thanksgiving with Harry Slusher.

Mr. and Mrs. James Winters of Paris visited Mr. and Mrs. Roy Powers during Thanksgiving holidays.

Mr. and Mrs. Clyde Smith had Thanksgiving dinner with Mrs. Viola Humphrey and Mrs. Audrey Gillis of Bogata.

Mr. and Mrs. Eugene Norwood, Frankie Norwood, Mr. and Mrs. Scottie Norwood and Amber, Mr. and Mrs. Billy Ray Ots, Brandon and Georjeana, Mr. and Mrs. James Norwood and Mendy, Mr. and Mrs. Rodney Norwood and Jace, Mr. and Mrs. Darold Norwood of Paris and Teresa Norwood were guests of Mr. and Mrs. Almer Norwood for Thanksgiving supper.

Mr. and Mrs. Emil Mock and Mrs. Linda Jo Cannon and Christopher of Dallas and Mr. and Mrs. Salvador Hernandez and family of Dallas and Mrs. Hazel Dobbs of Clardy were Thanksgiving dinner guests of Mrs. Delcia Wilson.

Kelly Anderson of Bogata spent the weekend with her father, Mickey Anderson.

Mr. and Mrs. Gordon Cox and family of Alvarado, Mr. and Mrs. Raymond Gaylord and Leel of Baytown and Morris Cox of Waxahachie spent Thanksgiving with Velma Cox.

Mr. and Mrs. Mike Fowler, Christi and Mandi of Mesquite, Mr. and Mrs. Talm A Fowler and Melanie of Pattonville and Mrs. Carol Dorsey and Jennifer of Mesquite spent Thanksgiving holidays with Mr. and Mrs. Willie J. Fowler.

Mr. and Mrs. Conard Norwood of Katy spent Thanksgiving at their home here.

Stephanie Jaco of Paris spent the week with Mrs. Delcia Wilson.

Mr. and Mrs. Dudley Batch of Sulphur Springs visited Stella Crafton Sunday afternoon.

Mrs. Jo Gordon of Ft. Worth, Mr. and Mrs. Charles Davis, Jeff and Terry of Omaha, Mrs. J.D. Crews of Paris, Mr. and Mrs. L.D. Malone and family of Vasco, Gary Bridges, Geri Kay and Brandon of Bogata visited Mrs. Delphia Malone during the Thanksgiving holidays.

The family of Nina Anderson and the late C.W. Anderson met at the community center for Thanksgiving dinner. Attending were Lola Belle Joiner and Dempsey Griffin of Garland, Mr. and Mrs. Sam Speir, Mike, Gregg, Christi and Chad of Celeste, Mr. and Mrs. Ed Barnett and son, Tracy Smith and Mr. and Mrs. Joel Smith, Mr. and Mrs. Jimmy Anderson and Josh of Paris, Mr. and Mrs. George Newberry, Jesse and Jeremy of Marvin, Mr. and Mrs. Randy Anderson of Jolintown, Mr. and Mrs. Kim Pahn and family of Sherman, Kelly Anderson of Bogata, Mr. and Mrs. Don Jackson of Lamar Point, Mr. and Mrs. Ricky Anderson, Rusty and Wendy, Mickey Anderson, Mrs. Della Howe, Mrs. Nina Anderson and Burks Dockrey of Cunningham.

John C. Allen of Blossom visited Mr. and Mrs. Fred Allen Sunday afternoon.

Mr. and Mrs. Charles B. Pynes and Dennis Pynes of Paris, Mr. and Mrs. Kenny Gifford, Brandon, Fair Shea and Trey of Deport, Mr. and Mrs. Frank Ogden of Longview, Mr. and Mrs. J.O. Fletcher and Jimmy Ray Landrum of Texarkana, Mr. and Mrs. Wayne Moore and Gaylia Lee of Hooks, Mr. and Mrs. Donnie Pierson of Dallas, Mr. and Mrs. Darwin Pynes of Deport and Mrs. Clifford Pynes had Thanksgiving dinner with Mr. and Mrs. Dennis Bazhaw and family.

Ray Blesoe of Muskogee, Ok, Mr. and Mrs. Gene Frierson and Mrs. Edith Smith of Paris, Tony Duncan of Blossom, Mr. and Mrs. Eugene Norwood, Frankie Norwood, Mr. and Mrs. Scottie Norwood and Amber, Mr. and Mrs. Johnny Musgrove and Zarinska, Mr. and Mrs. Stacy Musgrove and Stoney, Mr. and Mrs. Dean Watson, Jarvis, Deana, Bruce and Brad, Mrs. Billy Ray Oats and Brandon were guests of Mr. and Mrs. Almer Norwood Thanksgiving day.

Milow Hume and Stasha had dinner with Mr. and Mrs. Weldon George of Paris Thanksgiving day.

Mr. and Mrs. Billie Joe Oats, Mrs. George Taylor, Mr. and Mrs. Billy Ray Oats, Brandon and Georjeana were Thanksgiving dinner guests of Mr. and Mrs. Leslie Stuart of Reno.

Mr. and Mrs. Fred Allen with Mr. and Mrs. Bob Allen and family of Blossom and Mr. and Mrs. Terry Fry and family of Paris were Thanksgiving dinner guests of Mr. and Mrs. Robert Shannon at their home in Sylvan.

Mr. and Mrs. John L. Allen of Arlington and Mrs. Robert Shannon of Euless visited Mr. and Mrs. Fred Allen Saturday.

Mr. and Mrs. John Wester of Washington, AR spent Friday night with Mr. and Mrs. Almer Norwood.

Enjoying Thanksgiving dinner with Mr. and Mrs. Johnnie Pope of Clarksville were Mr. and Mrs. Charlie Smith of Reno, Mr. and Mrs. Victor Smith and Kevin of Dallas, Mrs. Willie Clay Norwood of Reno, Billy Jack Norwood of Paris, Teresa Smith of Dallas.

Mrs. Goldie Brown of Blessing, Mr. and Mrs. W.M. Brown of Bloomington, Mr. and Mrs. Carl Guthrie of Talco and Mr. and Mrs. Larry Bell visited Mr. and Mrs. Norman Sain and Mrs. Ida Deshong during Thanksgiving holidays.

Mr. and Mrs. Bob Baugh of Pattonville had Thanksgiving breakfast at Mr. and Mrs. Ira Taylor's.

Mr. and Mrs. Charlie Smith of Reno visited Mr. and Mrs. John B. Whitney Sunday afternoon.

Mr. and Mrs. John Buford Whitney attended a birthday dinner Sunday honoring their grandson Shane Curin in the home of Mr. and Mrs. Johnnie Pope of Clarksville.

Mr. and Mrs. Clovis Morrison of Caviness and Alva Mae O'Neal of Paris had Thanksgiving dinner with Mr. and Mrs. Pete McKnight.

Mr. and Mrs. Donald Smith of Deport, Mrs. Sue Goley and Mrs. Rhonda Akers and Andrew of Paris and Mr. and Mrs. Bobby Merchant, Stephanie and Bobbie Jo of Bogata were Thanksgiving Holiday visitors of Mr. and Mrs. Alfonso Smith.

Mr. and Mrs. David Jaco and Paula of Paris and Mrs. Hazel Dobbs of Clardy visited Mrs. Delcia Wilson Sunday.

Mr. and Mrs. Cecil Ruyle of Taylortown and Donald Smith of Paris visited Mr. and Mrs. Clyde Smith Sunday afternoon.

Mr. and Mrs. Roy Powers visited with the family of Odis King at the Bright Funeral Home Sunday.

Mr. and Mrs. Almer Norwood were supper guests of Mr. and Mrs. Conard Norwood Saturday.

Mr. and Mrs. Boyd Betterton of Baytown visited Mr. and Mrs. William Cooper last week.

Mr. and Mrs. William Cooper with Mr. and Mrs. Ricky Cooper and Ryan of Clardy, Mr. and Mrs. Brit Phillips, Lindy Jo and Bonnie Sue of Lone Star, Mrs. Randall Childress, Steven and Justin of Sanitorium, MS had Thanksgiving dinner with Mr. and Mrs. Weldon Smith of Bogata.

Mr. and Mrs. Rab Skidmore of Deport visited Mr. and Mrs. Roy Powers Sunday afternoon.

Ronnie White, Jonathan and Dameron of Sulphur Springs visited Mr. and Mrs. Almer Norwood Sunday.

Rev. and Mrs. Don Whit of Hot Springs, AR were Sunday dinner guests of Mr. and Mrs. Pete McKnight.

## "Amahl" To Feature Local Students

Paris Junior College's production of Amahl and the Night Visitors will feature college music and drama students along with some area talent, said Ray Karrer, director for the Christmas presentation. The colorful production of Gian-carlo Menotti's one-act opera will be presented Dec. 6, 7 and 8 in the Theater at PJC.  
Reuel Swint, a sixth grade student at Cecil Everett Elementary School, will play Amahl, the crippled

shepherd boy whose life is changed forever the night he sees the three Kings.  
Portraying his poor widowed mother will be Amy Hiner, PJC music student from Rockwall. David Smith, who plays Kasper, is a former Paris High School music and drama student.  
Also a PHS graduate, Aubrey Robertson is a music major at PJC and played the lead in the musical, Robber Bridegroom, last year. He will portray Melchior in Amahl and the Night Visitors. Tim McNeil, who will be Balthazar, is a graduate of Pine Tree High School in Longview.  
Dancers for Amahl and the Night Visitors will be Chance Dawson and Andy Pryor of Clarksville, Melissa Thompson of Hugo.  
Members of the shepherd's chorus will be Jeff Stone of Pattonville and Tim Wood of Bogata.  
Tickets for the play, to go on sale November 25 in the College Store, are \$4 for general admission, \$2 for students and free to PJC students.

## NTCC Choir To Present Christmas Program

On Sunday, December 8 at 3:30 p.m., the Northeast Texas Community Chorus will present a program of Christmas choral music in the Student Union Building on the NTCC campus.  
The featured highlight on Sunday's program will be a performance of George Frederick Handel's best known and loved work "The Messiah".  
The Northeast Texas Community Chorus, conducted by Dr. Ron Clinton, is a group of 45 of the finest singers from the Northeast Texas area.  
Come celebrate the coming Christmas season and hear the first performance of the Northeast Texas Community Chorus in a singing tribute to Christmas. The performance is open to the public at no charge.  
For more information, call Dr. Clinton at 1-800-441-8568 or 572-1911.

**THE CHRISTMAS**  
*That will never be forgotten*

MIC VISA American Express

**M & M JEWELERS**

For the best selection of BEAUTIFUL JEWELRY and just the RIGHT GIFT for everyone on your CHRISTMAS LIST

**OPEN SUNDAY 1 p.m.-5 p.m.**

For your Shopping Convenience  
Layaway Welcome

1535 Clarksville, Paris, TX.  
Williamsburg Center  
214-784-5321

**PRICE! PRICE! PRICE!**  
**PRICE FORD LINCOLN MERCURY**  
Made In The USA by Americans!

New '86 Cars Are Arriving Daily, Plus We Have A Good Selection In Stock To Choose From, At Prices No Other Dealer Will Give. Because Price Is Our Name At Price Ford-Lincoln-Mercury!

- ★ Lincoln Town Cars 4 Door Start at \$18,900
- ★ Mercury Grand Marquis Wagon 4 Door Start at \$13,400
- ★ Mercury Topaz 2 Door Sedan Start at \$7895
- ★ Mark VII 2 Door Start at \$21,900
- ★ Mercury Lynx 2 Door Sedan Start at \$6495
- ★ Mercury Topaz 4 Door Sedan Start at \$7995
- ★ Mercury Grand Marquis 4 Door Sedan Start at \$13,500
- ★ Mercury Lynx 4 Door Sedan Start at \$6595
- ★ Mercury Capri 2 Door Sedan Start at \$9495
- ★ Mercury Sable 4 Door Sedan Start at \$10,400
- ★ Mercury Cougar Start at \$12,900

Little Or No Down Payment!

Our Salesmen Are Available 7 Days A Week And After Hours!

Save Your Cash! Lease a new car or truck from Price Ford-Lincoln-Mercury and Save As Much As \$150 A Month On Your Lease Payment.

If We Don't Have The Unit You Want In Stock, We Can Get It Within 24 Hours!

Bank Rate Financing Available! **PRICE FORD-LINCOLN-MERCURY**  
1040 Gilmer 885-3187

**WARD'S CASH & CARRY GROCERY**  
TALCO, TEXAS Under New Ownership - Good Stock  
OPEN 7 Days Week 6:30 a.m. to 6:30 p.m.

<b>BACON</b> Slab Sliced Lb. \$1.29	<b>GROUND MEAT</b> Lb. \$1.19	<b>STEAK</b> Round Lb. \$1.79
<b>MILK</b> Borden's-Gallon \$2.29	<b>BUTTERMILK</b> Borden's 1/2 Gallon 99¢	<b>EGGS</b> Dozen 89¢
<b>TUNA</b> Star-Kist 6 1/2oz. Can 89¢	<b>FLOUR</b> Gladiola 5 Lb. Bag 95¢	<b>CHEESE</b> Kraft Deluxe American 12oz. Pkg. \$1.39
<b>LETTUCE</b> Head 49¢	<b>TOMATOES</b> Lb. 49¢	<b>POTATOES</b> 10 Lb. Bag \$1.09
<b>MARSHMALLOW CREAM</b> Kraft 69¢	<b>TOMATO SAUCE</b> Del Monte 8oz. Can 4/\$1	<b>MACARONI &amp; CHEESE</b> Kraft Dinner 2/79¢
<b>CORN</b> 3-Ring 3/\$1	<b>BREAD</b> Mrs. Bairds Sta Fresh 69¢	<b>BEANS</b> Ranch Style 15oz. Can 2/79¢
<b>TISSUE</b> Northern 4 Rolls \$1.19	<b>BOLD 3</b> Detergent 42oz. Box \$1.99	<b>PUREX</b> Bleach-Gallon 95¢

**WEEKEND CROSSWORD**

THIS WEEK'S PUZZLE ANSWER

ACROSS

- "Some \_\_\_ born great."
- Adage
- Smear
- Scarlett's plantation
- Gr. letter
- St. Patrick's land
- Roman poet
- Letter opener
- Journing word
- Spillane's character
- Arab chieftan
- Meadow sound
- Quarterback problem
- Second drink
- Yachting
- Dies
- Magician of yore
- Pungent flavoring
- Dish commune
- Sofa
- Michael J. Fox's sitcom
- Chemist Hahn
- Bikini top
- Paul of songs
- Dock

DOWN

- Energy source
- Sitarist Shankar
- "CHIPS" Estrada
- Til
- "One Day at \_\_\_"
- More ardent
- Lager
- Falsehood
- Footed vase
- Actor Alejandro
- Sidewalk stand
- quaff
- "2001" computer
- Poetic palindrome
- Spin alog
- Jai
- Author Waugh
- "Show Biz" school show
- Secondhand
- Only
- Dance in Patee
- Evergreen
- Mrs. Cantor
- Agile
- "In a \_\_\_ far, far away"
- Some
- Kind of pneumonia
- A President
- Make lace
- Concerning
- Made do, barely
- "Simon \_\_\_"
- Choose
- Dead heat
- Derek's number

1 2 3 4 5 6 7 8 9 10  
11 12 13 14  
15 16 17  
18 19 20  
21 22 23 24  
25 26 27 28 29 30  
31 32  
33 34 35 36 37  
38 39 40  
41 42 43 44 45  
46 47 48 49 50  
51 52 53  
54 55 56

have a nice weekend



# CHRISTMAS GIFT IDEAS

## YOUR HOMETOWN NEWSPAPER

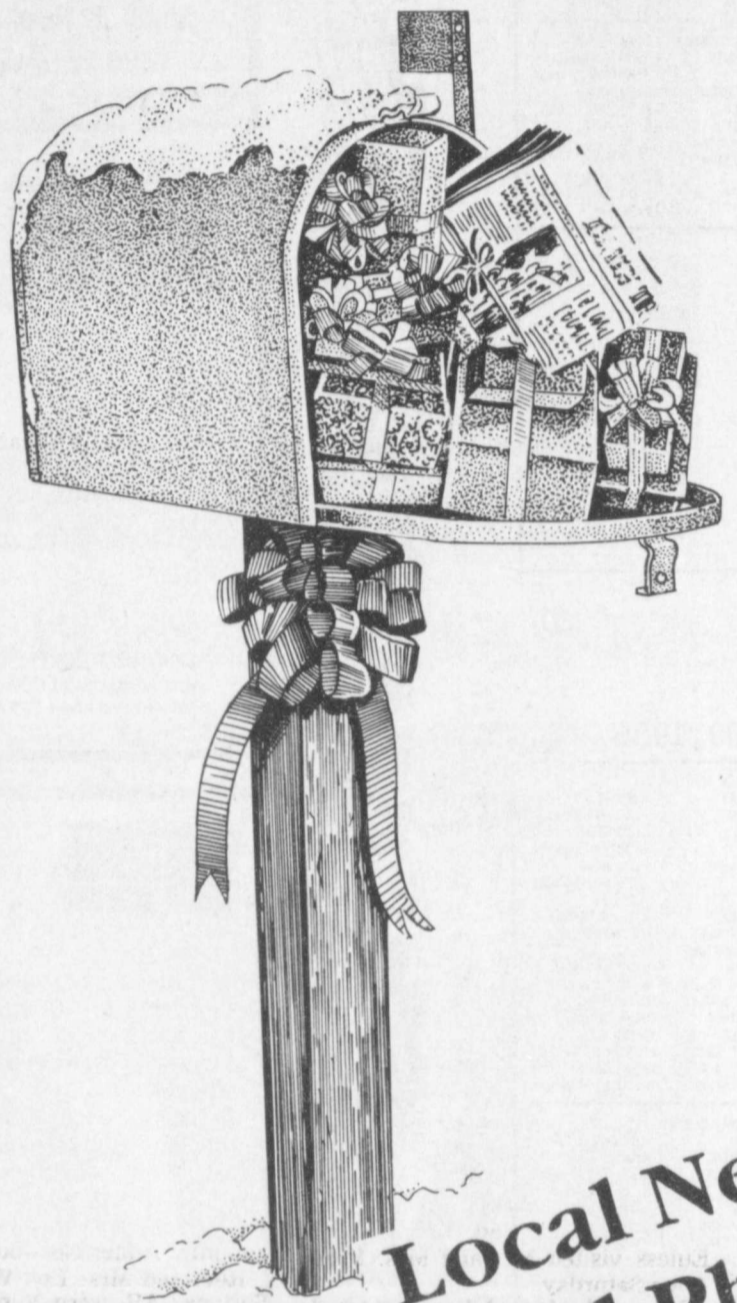

# Sale

Through The  
Month Of  
December

# SAVE \$2

On The  
**DEPORT TIMES, BOGATA NEWS,  
TALCO TIMES Or BLOSSOM TIMES!**

Local News  
Local Photos  
School Events  
TV Schedule

**\$800** In Lamar, Red River  
and Titus Counties  
**\$1050** Within The State, But Not  
In Above Counties  
**\$1300** Out of State

# PLUS!

**NEW** Subscribers Can Take  
An **ADDITIONAL \$2**  
That's Right, a total  
of \$4 off To **NEW**  
Subscribers!  
The **LOWEST** Price in Years!



Return This Blank With Your Check  
Enjoy Home Town News All Next Year

Name \_\_\_\_\_  
Address \_\_\_\_\_  
City \_\_\_\_\_  
State \_\_\_\_\_ Zip \_\_\_\_\_

Amount Enclosed  
 Are You Getting The Paper Now?  
 Is This A New Subscription?

**The Deport Times**  
Box 98, Deport, Tex. 75435  
**The Bogata News**  
Box 306, Bogata, Tex. 75417  
**The Talco Times**  
Box 98, Deport, Tex. 75435  
**The Blossom Times**  
Box 98, Deport, Tex. 75435

The Perfect Gift At A Great Price!  
Where Else Can You Buy A Gift  
That Lasts ALL YEAR LONG  
Complete Your Christmas  
Gift List TODAY...and  
Don't Forget To Put  
Yourself On It Too.

with  
e of  
arlie  
ctor  
Mrs.  
Billy  
Smith  
g, Mr.  
loom-  
rie of  
Bell  
Sain  
aring  
atton-  
ast at  
Reno  
itney  
itney  
nday  
Cur-  
John-  
on fo  
al of  
with  
th of  
Mrs.  
Paris  
hant,  
gata  
ors of  
Paula  
bs of  
Wilson  
aylor-  
Paris  
Sun-  
visitd  
at the  
were  
onard  
on of  
Mrs.  
with  
Ryan  
illips,  
Star,  
teven  
had  
and  
re of  
Roy  
d Da-  
d Mr.  
day,  
of Hot  
inner  
Pete  
nged  
three  
wed  
PJC  
avid  
mer  
ama  
brey  
PJC  
ical,  
He  
and  
who  
te of  
view.  
ight  
and  
Lissa  
orus  
and  
sale  
are  
for  
nts.  
3:30  
uni-  
n of  
Stu-  
CC  
ay's  
of  
est  
The  
ity  
lin-  
est  
xas  
ing  
rst  
xas  
ate  
is  
lin-



# Thunder Prairie TV Listings

## THURSDAY

DECEMBER 05, 1985

<b>3 KTBS SHREVEPORT</b> 7:00 GOOD 7:30 MORNING 8:00 AMERICA 8:30 NEWS 9:00 MAKE/DEAL 9:30 HEADLINE 10:00 CATCHPHRASE 10:30 ALL STAR 11:00 RYAN'S HOPE 11:30 LOVING 12:00 ALL MY 12:30 CHILDREN 1:00 ONE LIFE 1:30 TO LIVE 2:00 GENERAL 2:30 HOSPITAL 3:00 HOUR 3:30 MAGAZINE	<b>4 KDFW DALLAS</b> 7:00 CBS MORNING 7:30 NEWS 8:00 NEWS 8:30 CBS NEWS 9:00 MAKE/DEAL 9:30 PRESS/LUCK 10:00 PRICE IS 10:30 GRAMMY 11:00 YOUNG AND RESTLESS 11:30 AS THE 12:00 NEWS 12:30 AS THE 1:00 WORLD TURNS 1:30 CAPITOL 2:00 GUIDING 2:30 LIGHT 3:00 PM MAGAZINE 3:30 SANFORD	<b>5 KXAS DALLAS</b> 7:00 TODAY 7:30 MORNING 8:00 NEWS 8:30 CBS NEWS 9:00 DONAHUE 9:30 NEWS 10:00 SANTA 10:30 BARBARA 11:00 SCRABBLE 11:30 NEWS 12:00 NEWS 12:30 NEWS 1:00 NEWS 1:30 NEWS 2:00 NEWS 2:30 NEWS 3:00 NEWS 3:30 NEWS	<b>6 KTAL SHREVEPORT</b> 7:00 TODAY 7:30 MORNING 8:00 NEWS 8:30 NEWS 9:00 DIVORCE CRT 9:30 MAUDE 10:00 WH/FORTUNE 10:30 SCRABBLE 11:00 PASSWORD 11:30 AMK-LA-TEX 12:00 DAYS OF 12:30 OUR LIVES 1:00 ANOTHER 1:30 WORLD 2:00 SANTA 2:30 BARBARA 3:00 TIC TAC DO 3:30 JOKER WILD	<b>7 KLTW TYLER</b> 7:00 GOOD 7:30 MORNING 8:00 NEWS 8:30 NEWS 9:00 HOUR 9:30 MAGAZINE 10:00 3'S COMPANY 10:30 STAR BLITZ 11:00 RYAN'S HOPE 11:30 LOVING 12:00 ALL MY 12:30 CHILDREN 1:00 NEWS 1:30 TO LIVE 2:00 GENERAL 2:30 HOSPITAL 3:00 DALLAS 3:30 LETTERMAN	<b>8 WFAA DALLAS</b> 7:00 GOOD 7:30 MORNING 8:00 NEWS 8:30 CBS NEWS 9:00 HOUR 9:30 MAGAZINE 10:00 ALL STAR 10:30 LOVING 11:00 RYAN'S HOPE 11:30 LOVING 12:00 ALL MY 12:30 CHILDREN 1:00 NEWS 1:30 TO LIVE 2:00 GENERAL 2:30 HOSPITAL 3:00 DALLAS 3:30 THIS WEEK
---	--	---	--	---	---

## VIDEO VIEWING SUNDAY

DECEMBER 08, 1985

<b>3 KTBS SHREVEPORT</b> 7:00 JIM BAKER 7:30 MORNING 8:00 AMERICA 8:30 NEWS 9:00 DISCOVERY 9:30 NEWS 10:00 REVELATION 10:30 JIMMY 11:00 INSIDE STORY 11:30 NEWS 12:00 NEWS 12:30 NEWS 1:00 NEWS 1:30 NEWS 2:00 NEWS 2:30 NEWS 3:00 NEWS 3:30 NEWS	<b>4 KDFW DALLAS</b> 7:00 CBS MORNING 7:30 NEWS 8:00 NEWS 8:30 CBS NEWS 9:00 MAKE/DEAL 9:30 PRESS/LUCK 10:00 PRICE IS 10:30 GRAMMY 11:00 YOUNG AND RESTLESS 11:30 AS THE 12:00 NEWS 12:30 AS THE 1:00 WORLD TURNS 1:30 CAPITOL 2:00 GUIDING 2:30 LIGHT 3:00 PM MAGAZINE 3:30 SANFORD	<b>5 KXAS DALLAS</b> 7:00 TODAY 7:30 MORNING 8:00 NEWS 8:30 CBS NEWS 9:00 DONAHUE 9:30 NEWS 10:00 SANTA 10:30 BARBARA 11:00 SCRABBLE 11:30 NEWS 12:00 NEWS 12:30 NEWS 1:00 NEWS 1:30 NEWS 2:00 NEWS 2:30 NEWS 3:00 NEWS 3:30 NEWS	<b>6 KTAL SHREVEPORT</b> 7:00 TODAY 7:30 MORNING 8:00 NEWS 8:30 NEWS 9:00 DIVORCE CRT 9:30 MAUDE 10:00 WH/FORTUNE 10:30 SCRABBLE 11:00 PASSWORD 11:30 AMK-LA-TEX 12:00 DAYS OF 12:30 OUR LIVES 1:00 ANOTHER 1:30 WORLD 2:00 SANTA 2:30 BARBARA 3:00 TIC TAC DO 3:30 JOKER WILD	<b>7 KLTW TYLER</b> 7:00 GOOD 7:30 MORNING 8:00 NEWS 8:30 NEWS 9:00 HOUR 9:30 MAGAZINE 10:00 3'S COMPANY 10:30 STAR BLITZ 11:00 RYAN'S HOPE 11:30 LOVING 12:00 ALL MY 12:30 CHILDREN 1:00 NEWS 1:30 TO LIVE 2:00 GENERAL 2:30 HOSPITAL 3:00 DALLAS 3:30 LETTERMAN	<b>8 WFAA DALLAS</b> 7:00 GOOD 7:30 MORNING 8:00 NEWS 8:30 CBS NEWS 9:00 HOUR 9:30 MAGAZINE 10:00 ALL STAR 10:30 LOVING 11:00 RYAN'S HOPE 11:30 LOVING 12:00 ALL MY 12:30 CHILDREN 1:00 NEWS 1:30 TO LIVE 2:00 GENERAL 2:30 HOSPITAL 3:00 DALLAS 3:30 THIS WEEK
---	--	---	--	---	---

## VIDEO VIEWING FRIDAY

DECEMBER 06, 1985

<b>3 KTBS SHREVEPORT</b> 7:00 GOOD 7:30 MORNING 8:00 AMERICA 8:30 NEWS 9:00 MAKE/DEAL 9:30 HEADLINE 10:00 CATCHPHRASE 10:30 ALL STAR 11:00 RYAN'S HOPE 11:30 LOVING 12:00 ALL MY 12:30 CHILDREN 1:00 ONE LIFE 1:30 TO LIVE 2:00 GENERAL 2:30 HOSPITAL 3:00 HOUR 3:30 MAGAZINE	<b>4 KDFW DALLAS</b> 7:00 CBS MORNING 7:30 NEWS 8:00 NEWS 8:30 CBS NEWS 9:00 MAKE/DEAL 9:30 PRESS/LUCK 10:00 PRICE IS 10:30 GRAMMY 11:00 YOUNG AND RESTLESS 11:30 AS THE 12:00 NEWS 12:30 AS THE 1:00 WORLD TURNS 1:30 CAPITOL 2:00 GUIDING 2:30 LIGHT 3:00 PM MAGAZINE 3:30 SANFORD	<b>5 KXAS DALLAS</b> 7:00 TODAY 7:30 MORNING 8:00 NEWS 8:30 CBS NEWS 9:00 DONAHUE 9:30 NEWS 10:00 SANTA 10:30 BARBARA 11:00 SCRABBLE 11:30 NEWS 12:00 NEWS 12:30 NEWS 1:00 NEWS 1:30 NEWS 2:00 NEWS 2:30 NEWS 3:00 NEWS 3:30 NEWS	<b>6 KTAL SHREVEPORT</b> 7:00 TODAY 7:30 MORNING 8:00 NEWS 8:30 NEWS 9:00 DIVORCE CRT 9:30 MAUDE 10:00 WH/FORTUNE 10:30 SCRABBLE 11:00 PASSWORD 11:30 AMK-LA-TEX 12:00 DAYS OF 12:30 OUR LIVES 1:00 ANOTHER 1:30 WORLD 2:00 SANTA 2:30 BARBARA 3:00 TIC TAC DO 3:30 JOKER WILD	<b>7 KLTW TYLER</b> 7:00 GOOD 7:30 MORNING 8:00 NEWS 8:30 NEWS 9:00 HOUR 9:30 MAGAZINE 10:00 3'S COMPANY 10:30 STAR BLITZ 11:00 RYAN'S HOPE 11:30 LOVING 12:00 ALL MY 12:30 CHILDREN 1:00 NEWS 1:30 TO LIVE 2:00 GENERAL 2:30 HOSPITAL 3:00 DALLAS 3:30 LETTERMAN	<b>8 WFAA DALLAS</b> 7:00 GOOD 7:30 MORNING 8:00 NEWS 8:30 CBS NEWS 9:00 HOUR 9:30 MAGAZINE 10:00 ALL STAR 10:30 LOVING 11:00 RYAN'S HOPE 11:30 LOVING 12:00 ALL MY 12:30 CHILDREN 1:00 NEWS 1:30 TO LIVE 2:00 GENERAL 2:30 HOSPITAL 3:00 DALLAS 3:30 THIS WEEK
---	--	---	--	---	---

## VIDEO VIEWING MONDAY

DECEMBER 09, 1985

<b>3 KTBS SHREVEPORT</b> 7:00 GOOD 7:30 MORNING 8:00 AMERICA 8:30 NEWS 9:00 MAKE/DEAL 9:30 HEADLINE 10:00 CATCHPHRASE 10:30 ALL STAR 11:00 RYAN'S HOPE 11:30 LOVING 12:00 ALL MY 12:30 CHILDREN 1:00 ONE LIFE 1:30 TO LIVE 2:00 GENERAL 2:30 HOSPITAL 3:00 HOUR 3:30 MAGAZINE	<b>4 KDFW DALLAS</b> 7:00 CBS MORNING 7:30 NEWS 8:00 NEWS 8:30 CBS NEWS 9:00 MAKE/DEAL 9:30 PRESS/LUCK 10:00 PRICE IS 10:30 GRAMMY 11:00 YOUNG AND RESTLESS 11:30 AS THE 12:00 NEWS 12:30 AS THE 1:00 WORLD TURNS 1:30 CAPITOL 2:00 GUIDING 2:30 LIGHT 3:00 PM MAGAZINE 3:30 SANFORD	<b>5 KXAS DALLAS</b> 7:00 TODAY 7:30 MORNING 8:00 NEWS 8:30 CBS NEWS 9:00 DONAHUE 9:30 NEWS 10:00 SANTA 10:30 BARBARA 11:00 SCRABBLE 11:30 NEWS 12:00 NEWS 12:30 NEWS 1:00 NEWS 1:30 NEWS 2:00 NEWS 2:30 NEWS 3:00 NEWS 3:30 NEWS	<b>6 KTAL SHREVEPORT</b> 7:00 TODAY 7:30 MORNING 8:00 NEWS 8:30 NEWS 9:00 DIVORCE CRT 9:30 MAUDE 10:00 WH/FORTUNE 10:30 SCRABBLE 11:00 PASSWORD 11:30 AMK-LA-TEX 12:00 DAYS OF 12:30 OUR LIVES 1:00 ANOTHER 1:30 WORLD 2:00 SANTA 2:30 BARBARA 3:00 TIC TAC DO 3:30 JOKER WILD	<b>7 KLTW TYLER</b> 7:00 GOOD 7:30 MORNING 8:00 NEWS 8:30 NEWS 9:00 HOUR 9:30 MAGAZINE 10:00 3'S COMPANY 10:30 STAR BLITZ 11:00 RYAN'S HOPE 11:30 LOVING 12:00 ALL MY 12:30 CHILDREN 1:00 NEWS 1:30 TO LIVE 2:00 GENERAL 2:30 HOSPITAL 3:00 DALLAS 3:30 LETTERMAN	<b>8 WFAA DALLAS</b> 7:00 GOOD 7:30 MORNING 8:00 NEWS 8:30 CBS NEWS 9:00 HOUR 9:30 MAGAZINE 10:00 ALL STAR 10:30 LOVING 11:00 RYAN'S HOPE 11:30 LOVING 12:00 ALL MY 12:30 CHILDREN 1:00 NEWS 1:30 TO LIVE 2:00 GENERAL 2:30 HOSPITAL 3:00 DALLAS 3:30 THIS WEEK
---	--	---	--	---	---

## VIDEO VIEWING SATURDAY

DECEMBER 07, 1985

<b>3 KTBS SHREVEPORT</b> 7:00 GOOD 7:30 MORNING 8:00 AMERICA 8:30 NEWS 9:00 MAKE/DEAL 9:30 HEADLINE 10:00 CATCHPHRASE 10:30 ALL STAR 11:00 RYAN'S HOPE 11:30 LOVING 12:00 ALL MY 12:30 CHILDREN 1:00 ONE LIFE 1:30 TO LIVE 2:00 GENERAL 2:30 HOSPITAL 3:00 HOUR 3:30 MAGAZINE	<b>4 KDFW DALLAS</b> 7:00 CBS MORNING 7:30 NEWS 8:00 NEWS 8:30 CBS NEWS 9:00 MAKE/DEAL 9:30 PRESS/LUCK 10:00 PRICE IS 10:30 GRAMMY 11:00 YOUNG AND RESTLESS 11:30 AS THE 12:00 NEWS 12:30 AS THE 1:00 WORLD TURNS 1:30 CAPITOL 2:00 GUIDING 2:30 LIGHT 3:00 PM MAGAZINE 3:30 SANFORD	<b>5 KXAS DALLAS</b> 7:00 TODAY 7:30 MORNING 8:00 NEWS 8:30 CBS NEWS 9:00 DONAHUE 9:30 NEWS 10:00 SANTA 10:30 BARBARA 11:00 SCRABBLE 11:30 NEWS 12:00 NEWS 12:30 NEWS 1:00 NEWS 1:30 NEWS 2:00 NEWS 2:30 NEWS 3:00 NEWS 3:30 NEWS	<b>6 KTAL SHREVEPORT</b> 7:00 TODAY 7:30 MORNING 8:00 NEWS 8:30 NEWS 9:00 DIVORCE CRT 9:30 MAUDE 10:00 WH/FORTUNE 10:30 SCRABBLE 11:00 PASSWORD 11:30 AMK-LA-TEX 12:00 DAYS OF 12:30 OUR LIVES 1:00 ANOTHER 1:30 WORLD 2:00 SANTA 2:30 BARBARA 3:00 TIC TAC DO 3:30 JOKER WILD	<b>7 KLTW TYLER</b> 7:00 GOOD 7:30 MORNING 8:00 NEWS 8:30 NEWS 9:00 HOUR 9:30 MAGAZINE 10:00 3'S COMPANY 10:30 STAR BLITZ 11:00 RYAN'S HOPE 11:30 LOVING 12:00 ALL MY 12:30 CHILDREN 1:00 NEWS 1:30 TO LIVE 2:00 GENERAL 2:30 HOSPITAL 3:00 DALLAS 3:30 LETTERMAN	<b>8 WFAA DALLAS</b> 7:00 GOOD 7:30 MORNING 8:00 NEWS 8:30 CBS NEWS 9:00 HOUR 9:30 MAGAZINE 10:00 ALL STAR 10:30 LOVING 11:00 RYAN'S HOPE 11:30 LOVING 12:00 ALL MY 12:30 CHILDREN 1:00 NEWS 1:30 TO LIVE 2:00 GENERAL 2:30 HOSPITAL 3:00 DALLAS 3:30 THIS WEEK
---	--	---	--	---	---

## VIDEO VIEWING TUESDAY

DECEMBER 10, 1985

<b>3 KTBS SHREVEPORT</b> 7:00 GOOD 7:30 MORNING 8:00 AMERICA 8:30 NEWS 9:00 MAKE/DEAL 9:30 HEADLINE 10:00 CATCHPHRASE 10:30 ALL STAR 11:00 RYAN'S HOPE 11:30 LOVING 12:00 ALL MY 12:30 CHILDREN 1:00 ONE LIFE 1:30 TO LIVE 2:00 GENERAL 2:30 HOSPITAL 3:00 HOUR 3:30 MAGAZINE	<b>4 KDFW DALLAS</b> 7:00 CBS MORNING 7:30 NEWS 8:00 NEWS 8:30 CBS NEWS 9:00 MAKE/DEAL 9:30 PRESS/LUCK 10:00 PRICE IS 10:30 GRAMMY 11:00 YOUNG AND RESTLESS 11:30 AS THE 12:00 NEWS 12:30 AS THE 1:00 WORLD TURNS 1:30 CAPITOL 2:00 GUIDING 2:30 LIGHT 3:00 PM MAGAZINE 3:30 SANFORD	<b>5 KXAS DALLAS</b> 7:00 TODAY 7:30 MORNING 8:00 NEWS 8:30 CBS NEWS 9:00 DONAHUE 9:30 NEWS 10:00 SANTA 10:30 BARBARA 11:00 SCRABBLE 11:30 NEWS 12:00 NEWS 12:30 NEWS 1:00 NEWS 1:30 NEWS 2:00 NEWS 2:30 NEWS 3:00 NEWS 3:30 NEWS	<b>6 KTAL SHREVEPORT</b> 7:00 TODAY 7:30 MORNING 8:00 NEWS 8:30 NEWS 9:00 DIVORCE CRT 9:30 MAUDE 10:00 WH/FORTUNE 10:30 SCRABBLE 11:00 PASSWORD 11:30 AMK-LA-TEX 12:00 DAYS OF 12:30 OUR LIVES 1:00 ANOTHER 1:30 WORLD 2:00 SANTA 2:30 BARBARA 3:00 TIC TAC DO 3:30 JOKER WILD	<b>7 KLTW TYLER</b> 7:00 GOOD 7:30 MORNING 8:00 NEWS 8:30 NEWS 9:00 HOUR 9:30 MAGAZINE 10:00 3'S COMPANY 10:30 STAR BLITZ 11:00 RYAN'S HOPE 11:30 LOVING 12:00 ALL MY 12:30 CHILDREN 1:00 NEWS 1:30 TO LIVE 2:00 GENERAL 2:30 HOSPITAL 3:00 DALLAS 3:30 LETTERMAN	<b>8 WFAA DALLAS</b> 7:00 GOOD 7:30 MORNING 8:00 NEWS 8:30 CBS NEWS 9:00 HOUR 9:30 MAGAZINE 10:00 ALL STAR 10:30 LOVING 11:00 RYAN'S HOPE 11:30 LOVING 12:00 ALL MY 12:30 CHILDREN 1:00 NEWS 1:30 TO LIVE 2:00 GENERAL 2:30 HOSPITAL 3:00 DALLAS 3:30 THIS WEEK
---	--	---	--	---	---

## WEDNESDAY

DECEMBER 11, 1985

<b>4 KDFW DALLAS</b> 7:00 CBS MORNING 7:30 NEWS 8:00 NEWS 8:30 CBS NEWS 9:00 MAKE/DEAL 9:30 PRESS/LUCK 10:00 PRICE IS 10:30 GRAMMY 11:00 YOUNG AND RESTLESS 11:30 AS THE 12:00 NEWS 12:30 AS THE 1:00 WORLD TURNS 1:30 CAPITOL 2:00 GUIDING 2:30 LIGHT 3:00 PM MAGAZINE 3:30 SANFORD	<b>5 KXAS DALLAS</b> 7:00 TODAY 7:30 MORNING 8:00 NEWS 8:30 CBS NEWS 9:00 DONAHUE 9:30 NEWS 10:00 SANTA 10:30 BARBARA 11:00 SCRABBLE 11:30 NEWS 12:00 NEWS 12:30 NEWS 1:00 NEWS 1:30 NEWS 2:00 NEWS 2:30 NEWS 3:00 NEWS 3:30 NEWS	<b>6 KTAL SHREVEPORT</b> 7:00 TODAY 7:30 MORNING 8:00 NEWS 8:30 NEWS 9:00 DIVORCE CRT 9:30 MAUDE 10:00 WH/FORTUNE 10:30 SCRABBLE 11:00 PASSWORD 11:30 AMK-LA-TEX 12:00 DAYS OF 12:30 OUR LIVES 1:00 ANOTHER 1:30 WORLD 2:00 SANTA 2:30 BARBARA 3:00 TIC TAC DO 3:30 JOKER WILD	<b>7 KLTW TYLER</b> 7:00 GOOD 7:30 MORNING 8:00 NEWS 8:30 NEWS 9:00 HOUR 9:30 MAGAZINE 10:00 3'S COMPANY 10:30 STAR BLITZ 11:00 RYAN'S HOPE 11:30 LOVING 12:00 ALL MY 12:30 CHILDREN 1:00 NEWS 1:30 TO LIVE 2:00 GENERAL 2:30 HOSPITAL 3:00 DALLAS 3:30 LETTERMAN	<b>8 WFAA DALLAS</b> 7:00 GOOD 7:30 MORNING 8:00 NEWS 8:30 CBS NEWS 9:00 HOUR 9:30 MAGAZINE 10:00 ALL STAR 10:30 LOVING 11:00 RYAN'S HOPE 11:30 LOVING 12:00 ALL MY 12:30 CHILDREN 1:00 NEWS 1:30 TO LIVE 2:00 GENERAL 2:30 HOSPITAL 3:00 DALLAS 3:30 THIS WEEK
--	---	--	---	---

**NOW OPEN FULL TIME**  
**EDDIE'S SERVICE CENTER**  
For Your Automotive Repairs  
**MONDAY-FRIDAY 8-5**  
**SATURDAY 8-12**  
MAIN ST. DEPT 652-2376

**J & J FLOORS**  
Carpet, Tile, Linoleum, Parquet  
Free Estimates  
Jewell A. Neathery Jr.  
120 W. Main St.  
CLARKSVILLE 214-427-5555

**FORD MERCURY LINCOLN**  
JAMES MILAM  
BUS 572-3486

**FORD MERCURY LINCOLN**  
DONNIE KECK FORD  
203 FERGUSON ROAD  
MT PLEASANT, TEXAS 75455

**FORD MERCURY LINCOLN**  
MIKE KRANER  
BUS 572-3486

**FORD MERCURY LINCOLN**  
DONNIE KECK FORD  
203 FERGUSON ROAD  
MT PLEASANT, TEXAS 75455

have a nice weekend

**SMITH CARPETS**  
Carpet-Linoleum-Tile  
Commercial & Residential  
24 Hour Installation  
More Quality For Your \$  
785-6491  
Largest Selection In N.E. Texas & S.E. Okla.  
Don Wear, Mgr. 1289 Clarksville St. Paris, Texas

**Bankhead Jewelers**  
415 N. Jefferson  
Mt. Pleasant, Texas 75455  
Business: 572-5441 Randy Bankhead Home: 572-4535

**6 KTAL SHREVEPORT**  
7:00 TODAY  
7:30 MORNING  
8:00 NEWS  
8:30 NEWS  
9:00 DIVORCE CRT  
9:30 MAUDE  
10:00 WH/FORTUNE  
10:30 SCRABBLE  
11:00 PASSWORD  
11:30 AMK-LA-TEX  
12:00 DAYS OF  
12:30 OUR LIVES  
1:00 ANOTHER  
1:30 WORLD  
2:00 SANTA  
2:30 BARBARA  
3:00 TIC TAC DO  
3:30 JOKER WILD





Mrs. Patrick B. Farr

### Gordon-Farr Exchange Wedding Vows

Miss Kristy LuAna Gordon became the bride of Patrick B. Farr in a formal double ring ceremony at 7:30 o'clock Saturday evening, November 30, in the Church of Christ, Highway 82 West, Clarksville. Gene Wolfe of Hurst, former minister of Northside Church of Christ in Bonham, officiated.

The bride is the daughter of Mr. and Mrs. George G. Gordon, Route 1, Deport, and the granddaughter of Mr. and Mrs. Leonard Massey. The bridegroom is the son of Mr. and Mrs. George Xenos of Bonham. His grandparents are Mr. and Mrs. Al Kreutzer of Bonham.

Mrs. Howard Dunham presided at the register in the church foyer. Miss Jennifer Dunham handed each guest a keepsake book marker.

A capella music was presented by Miss Angela Latimer who sang "Surround Me With Love" and "God, A Woman, and a Man". Alvis Dunlap sang "Always and Forever" and "Today My Love". Mr. and Mrs. Bob Buckel sang "Perhaps Love" as the processional for the bridal attendants, "With This Ring" during the ceremony and "Father, Hear This Prayer We Offer" at the close of the ceremony. Miss Latimer sang "Up Where We Belong" as the recessional. The bride entered to "Take My Hand" sung by the bride and groom. Gerry Allen read "Desiderate".

The aisle to the altar was lighted with hurricane lamps tied with burgundy ribbons. The altar was banked with fresh ferns, psalms, two oval 15 branched candelabras and two three-tiered candelabras holding burgundy candles. The focal point was three matching pedestals holding white Grecian urns filled with Boston fern. Lighting the altar area where the couple pledged their vows, was a grouping of hurricane lamps. Two matching seven-branched candelabras lighted the steps to the altar.

The bride, escorted to the altar and given in marriage by her father, wore a gown of white satin overlaid with sherr lace. The empire waistline formed a soft point at the back and the Queen Anne neckline was outlined with lace. The fitted bodice was trimmed with sequins and beaded lace medallions, and lace medallions accented the dip to the back waistline. The sheer, full sleeves were caught to a cuff and were decorated with lace and lace medallions. The slightly flared skirt was edged with lace and formed a train. The bride's fingertip veiling of illusion was caught to a garland of white chiffon flowers with a pouf of illusion and was edged with lace and lace medallions. She carried a cascade bouquet of roses, enchantment lilies and French carnations tied in ribbons and white lace. Tucked into the bouquet was a wedding handkerchief given to the bride by D.R. Nethery of Port Angeles, Washington.

Mrs. Johnny Robertson of Bogata, sister of the bride, was matron of honor and Beth Gordon of Clarksville, also a sister of the bride, was maid of honor. Bridesmaids were Marian Xenos of Texarkana, step-sister of the groom, Mrs. Jerry Kountz, sister of the groom, Mrs. Ronnie Latimer and Pam White, all of Bonham, Ms. Jane Kizer of Greenville, Annete Swaim of Houston and Staci Brooks of Paris.

The attendants wore formal length two-piece mauve satin gowns designed with a bateau neckline in front falling to a low drape in the back. The batwing sleeves tapered to the elbow and the loosely fitted bodice pulled in at the waistline with a wide self belt forming a softly gathered peplum. The slencer skirt featured a side pleat. Each wore a single strand of pearls, and each carried a burgundy candle surrounded with mauve roses, French carnations and azaleas tied with grey, navy and mauve ribbons. Each wore matching silk flowers in her hair.

Chay Robertson of Bogata, the bride's niece, was flower girl. She wore a long dress of mauve satin with a high band neckline, leg-o-mutton sleeves, gored skirt with a ruffle and a cummerbund.

She carried a pale mauve basket decorated with darker mauve and gray flowers tied with mauve ribbons.

Michael Noirris of Bonham was ringbearer.

Wayne Watson of Bonham served the bridegroom as best man. Groomsman were George Xenos, step-father of the groom, Ronnie Latimer, Mark Daniel and Jerry Kountz, all of Bonham, Ken McIntosh of Mesquite, Johnny Robertson of Bogata, Howard Dunham and Kenny Backus both of Clarksville.

Ushers were Bart Dunham and Darrell Dunham of Clarksville.

Candlelighters were Stacy Latimer of Bonham and Wyatt Bowden of Clarksville.

The bride's parents were hosts for a reception in the fellowship hall of the church following the ceremony.

The bride's table was laid with a white knit cloth covered with lace draped at intervals with white chiffon flowers and white lace ribbons. The appointments were of silver and crystal with a centerpiece of burgundy and mauve carnations in a stemmed crystal bowl. The bride's three-tiered colonade cake was decorated with white icing, fresh mauve roses with streamers of mauve ribbons and topped with a porcelain bride and groom. Punch was served from a silver punch bowl. Serving were Mrs. Bob Buckel of Gainesville, Mrs. Mike Wrinkle of Lubbock, Mrs. David Goodwin of Bonham and Mrs. Joe Kelsey of Bogata.

The groom's table was covered with a burgundy cloth. It held the silver coffee service, the groom's chocolate cake, nuts, mints, a centerpiece of a crystal lead fish supporting a burgundy candle tied with a navy bow and cascading English ivy. Serving were Mrs. Wayne Watson, Sherman, Mrs. Mark Daniel and Mrs. Jay Grizzle of Bonham and Tonya Cooper

of Clarksville.

Other members of the houseparty were Mrs. Ruby Bagwell, Mrs. Graham Ballard, Mrs. Kenneth Shelton, Mrs. Tom Collins, Mrs. Lewis Bartlett, Mrs. Lawrence Bell, Mrs. Marshall Warren and Mrs. Billy Ervin, all of Clarksville and Mrs. K.C. Winn, Jr. of Athens. Miss Paige Bowden and Miss Lauren Bowden of Clarksville distributed rice bags.

The bride is a graduate of Rivercrest High School, Paris Junior College and Abilene Christian University. She received her master's degree from East Texas State University and is a speech and hearing therapist in the Bonham Independent School District.

The bridegroom is a graduate of Collinsville High School, served in the United States Air Force and is

employed at the Veteran's Administration Center in Bonham.

Following a wedding trip to Oklahoma and Arkansas, the couple will make their home in Bonham.

Mr. and Mrs. George Xenos and Mr. and Mrs. Billy Ervin were hosts for a dinner Friday evening in the fellowship hall of the church following the wedding rehearsal. The groom presented gifts to his attendants.

A bridesmaid's luncheon honored Miss Gordon Saturday morning in the home of Mrs. Bill Jennings in Clarksville. Rice bags were made, and the honoree distributed gifts to her attendants.

Assisting with the luncheon and rice bag party were Mrs. Bob Buckel of Gainesville, Mrs. Rick Morgan of Abilene, Mrs. Johnny Robertson of Bogata and Beth Gordon of Clarksville.



### Lewis's To Celebrate 50th Anniversary

MR. AND MRS. LEROY Lewis of McCrury, will be honored with a golden wedding anniversary reception on Sunday, December 15 from 2 until 4 p.m. at the Bogata Community Center in Bogata, TX.

Hosts will be their children, Robert and Charley Lewis and families. Friends and relative are invited to attend. No formal invitations will be sent out.

### BIRTHS

Kenneth and Vickie Wilbanks announce the arrival of a son born on Thanksgiving Day 1985 at Parkland Memorial Hospital, Dallas. He weighed 6 lbs. 7 1/2 ozs. and was named Cody Wayne Wilbanks. Grandparents are Dan and Wanda Morgan, Talco, Mrs. Alice Ruth Jergins, Mesquite, and Buddy Wilbanks, Dallas. Great-grandparents are Mrs. Rosa Lee Ottinger, Talco; and Mr. and Mrs. George Hinson, Dallas.

### BIRTHS

Tashine Renee Chura is the name given to the daughter of Mr. and Mrs. David Chura on November 6 of San Jose, California. Grandparents are Mr. and Mrs. J.W. Kerbow of Los Gatos, California. Great-grandparents are Mr. and Mrs. J.J. Kerbow of Fulbright and Mrs. Steele of Sacramento, California.



### Whitney-Edge Announce Engagement

Gary Whitney and Bivian Edge will be exchanging wedding vows December 9th at 7 p.m. at the Maple Springs Church. A reception for the

bride and groom will be held at Mrs. Lucille Whitney's home following the ceremony. All friends and relatives are invited to attend.



## It's still not too late...

to open a 1985 IRA account.

Invest up to \$2000 for this year's contribution and the government will not tax that part of your income. Remember, a spouse can also save \$2000 yearly in an IRA working outside the home, but a housewife can save \$250<sup>00</sup> yearly.

Here At Talco State Bank your IRA can earn an 18-month fixed rate certificate compounded quarterly.

Protect yourself and your family in retirement years with an IRA. Everyone is eligible to participate.

And for maximum interest earned, start on your 1986 IRA as soon as you can.

# TALCO STATE BANK

FDIC

"... More hearth-warming than a heat pump!"

LONE STAR GAS

Proudly Presents

MY FAIR FURNACE

in

# The Gas Advantage

FEATURING  
a NATURAL GAS FURNACE

WARMER    LESS    EXTRA ENERGY    GREATER    MORE  
AIR FLOW · DRAFT · EFFICIENCY · COMFORT · ECONOMY

GET THE GAS ADVANTAGE  
A Natural For Your Home.

Lone Star Gas Company

NOW AT THE GAS APPLIANCE DEALER NEAREST YOU!



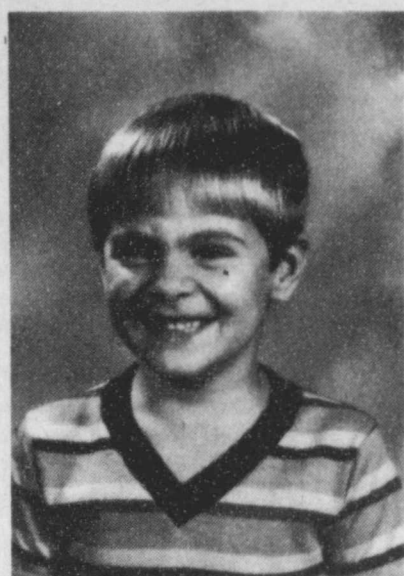

STEVEN HEARRON celebrated his 5th birthday with a party on Saturday, November 23. Steven will be five on Nov. 27. Gifts were opened then cake and punch were served. After eating, games were played and more pictures taken. Those present were Steven, his sister Susan, Kerri Case, Jonathan Smith, LaDonna Smith, Leslie Skelton, Heath Taylor, Joe Taylor, Keri Taylor, Lacie Taylor, Mrs. Shannon Hargrove, his mother Donna, Mrs. Brenda Smith, Mrs. Sandra Taylor, Mrs. Teresa Taylor, grandmothers, Mrs. Grace Hearron, Mrs. Vetrice Taylor and great-grandmother, Mrs. Nora Hearron.

### Stringfellow Enlists In Air Force

William W. Stringfellow, son of Mr. and Mrs. Jimmy Y. Stringfellow of Bogata, enlisted in the Air Force's Delayed Enlistment Program today, according to Sergeant Bryan L. Ross, Air Force Recruiter in Texarkana. Stringfellow, a 1985 graduate of Rivercrest High School, is scheduled for enlistment in the Regular Air Force on January 2, 1986. Upon graduation from the Air Force's six-

### SCHOOL Lunch Menu

Talco, Bogata and Rivercrest School Lunch Menu  
Dec. 9-Dec. 13  
Monday  
Chili mac  
Seasoned beans  
Cabbage slaw  
Chocolate cake  
Milk  
Tuesday  
Turkey and dressing  
Green beans  
Candied yams  
Hot rolls  
Cranberry sauce  
Milk  
Wednesday  
Chicken fried steak with gravy  
English peas  
Mashed potatoes  
Hot rolls  
Honey cup  
Milk  
Thursday  
Barbeque on bun  
Baked beans  
Potato salad  
Banana pudding  
Milk  
Friday  
Hamburgers  
Red beans  
Potato chips  
Lettuce and tomato  
Onions and pickles  
Ice cream  
Milk

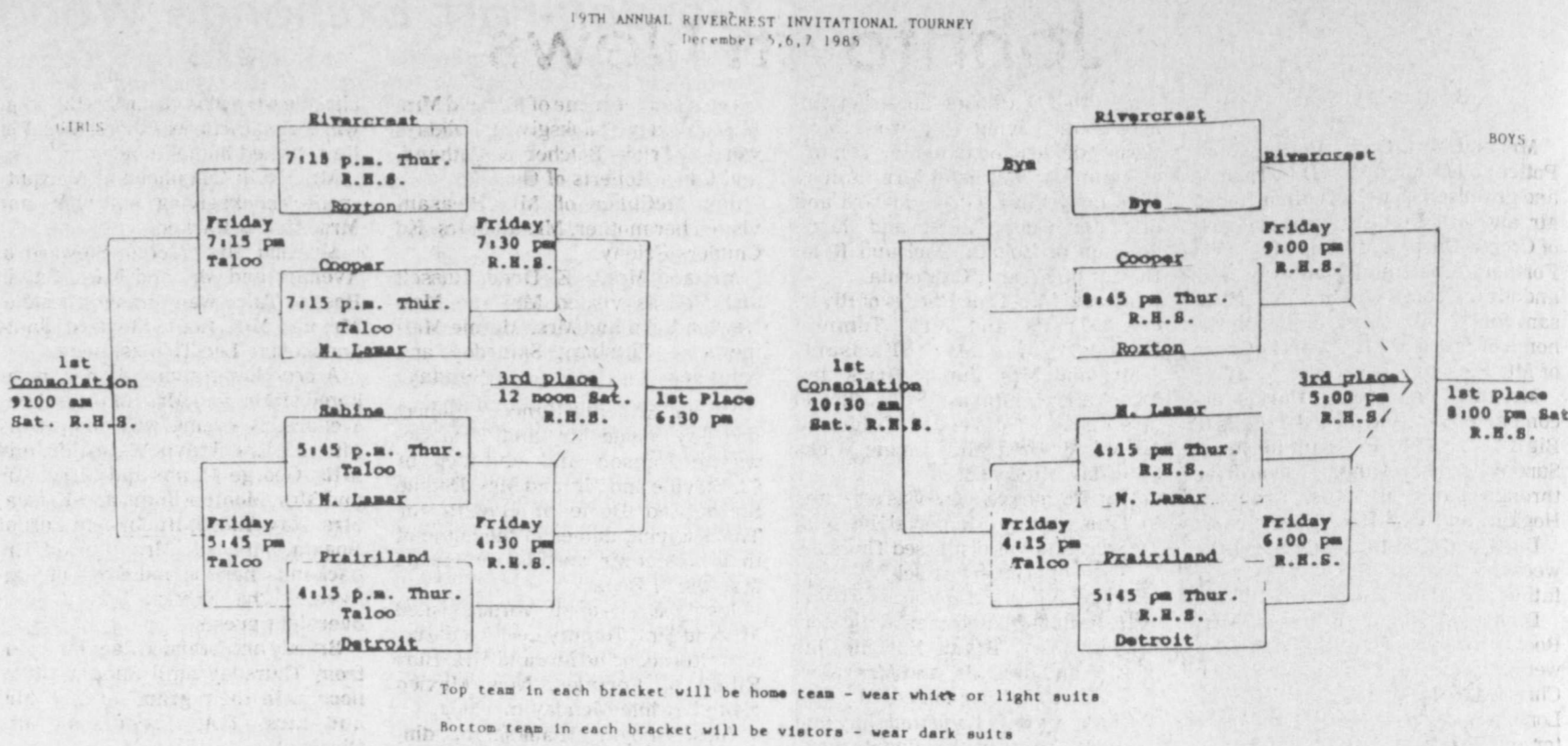

**SPECIAL Tom Landry**  
HAS COACHED THE DALLAS COWBOYS SINCE 1960, WHEN THE TEAM WAS FORMED. IN THE PAST 17 YEARS EVERY SEASON HAS BEEN A WINNING ONE. IN 23 YEARS, HIS RECORD:  
• 221 WINS  
• 129 LOSSES  
• 6 TIES  
INCLUDING 20 WINS AND 14 LOSSES IN THE PLAYOFFS. HIS TEAMS HAVE MADE THE SUPER BOWL 5 TIMES!  
LANDRY, A STUDY IN COMPOSURE AND CONCENTRATION, ALWAYS FIELDS A WELL-DISCIPLINED, TALENTED TEAM, ARMED WITH INTRICATE, UNUSUAL PLAYS AND FORMATIONS. SOMEONE ONCE JOKED ABOUT LANDRY'S PLAYBOOK GETTING SENT TO A CHINESE LAUNDRY BY MISTAKE. THEY SENT BACK 3 SHIRTS AND A LACE PILLOW CASE!

**1/2 PRICE SALE**  
Starting THURSDAY, Dec. 5th  
All Merchandise In Store 1/2 Price  
Except Red Wing Boots  
Special Price On Red Wing Boots  
**TURNERS DRY GOODS**  
BOGATA

### Hearrons Have Thanksgiving Dinner

The Hearron family observed their Thanksgiving Day and dinner in the home of Mr. and Mrs. Jerry Hearron, Joshua and Joey of Mt. Pleasant this year. Visiting in the home and eating dinner were Mr. Hearron's parents, Mr. and Mrs. I.L. Hearron of Talco and four of his brothers, Mr. and Mrs. Buddy Hearron and Anesya of Tyler; Mr. and Mrs. James Hearron and

Linda of Talco; Mr. and Mrs. Larry Hearron, Dustin and Tina of Wilkerson and Mr. and Mrs. Ray Hearron of Mt. Pleasant. Two of his sisters, Mr. and Mrs. Sherwin Darnell and Keith of Houston, Mr. and Mrs. Lren Stephens and Jason of Paris and one of his nephews, Mr. and Mrs. Randy Stephens of Paris. There were 28 served their lunch.

### Red River Water Supply Closes Loan

Officials of Red River County Water Supply Corporation and Farmers Home Administration had their formal closing of the FmHA financed \$1,042,600 loan. Representing Red River County WSC were Gene Wartham, president; Paul Hammer, vice-president; Dalton Moore, secretary-treasurer and directors Herman Lawler, Teddy Jones and Earl Humphrey; manager George Harvey and Supt. Henry Hoosier. Representing FmHA were Robert C. Toon, district director and Charles R. Cooke, Assistant director. According to Toon, FmHA director, Mt. Pleasant, FmHA and the Red River County WSC have been working as a team since 1966, in a joint effort to serve the rural communities of Red River County in providing water service. Toon stated that back in 1966, the residents of the rural communities were not served from a central water system, and that at that time, water for household and

livestock use was secured from shallow wells, cisterns and ground surface tanks. Since local rainfall is seasonal, there were times of the year when those sources were inadequate in quantity and quality to afford an adequate or safe source of water. Toon went on to say that through the dedication and efforts of concerned members of the corporation, they have grown from their first FmHA loan of \$625,000 in 1968 to serve approximately 480 families to the present FmHA loan, which will enable the corporation to serve approximately 1,475 families.

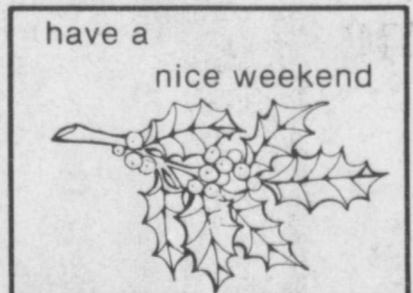

**SHELTON'S**  
PROPANE, FURNITURE & APPLIANCES  
MT. VERNON  
HWY. 37

**Howard Miller.**

# GUILD'S

CHOICE

**THE HAMPTON**  
•Mahogany Case  
•Beveled Glass Door  
•An Authentic Tempus Fugit Dial Reg. '999.  
SALE \$599.  
Save '400.

**THE ST. REGIS**  
•Oak Case  
•Inlaid Brass Trim  
•22 K Gold Trims the Glass and 24 K Plates the Spandrels Reg. '1999.  
SALE \$1,395.  
Save '604.

**THE CHARLESTON**  
•Cherrywood Case  
•Rare Mahogany Burl Accents  
•24 K Gold Plated Spandrels Reg. '2299.  
SALE \$1495.  
Save '804.

**THE BRIGADIER**  
•Cherry Bordeaux Case  
•Full Length Fluted Columns  
•Beveled Glass Door  
•Cable-driven, Triple Chime Movements Reg. '1895.  
SALE \$999.  
Save '895.

SHELTON'S \*  
W 1H 30 E  
N 1 Mile S Hwy 37

**SHELTON'S**  
Hwy. 37 — 1 Mile North Of I-30  
Mount Vernon, Texas 75742

Use Our Convenient Revolving Charge, MasterCard or Visa.

## BOGATA BUSINESS DIRECTORY

<p><b>RED RIVER COUNTY PUBLIC LIBRARY</b> Mon. Wed. Thurs. Fri. 12 to 5:30 p.m. Tue. 9 to 12 a.m. 1 to 5:30 p.m. Sat. 9 to 12 Noon</p>	<p><b>For This Space Call 632-5322</b></p>
<p><b>SLATON FURNITURE</b> Appliances, Carpet, Vinyl and Furniture East Side Square Clarksville, TX</p>	<p><b>APPLIANCE SALES &amp; SERVICE</b> Parts &amp; Service Available On Most Major Brand Appliances Call Today 427-5441 or 427-5990 Clarksville</p>
<p><b>HIGGINS COUNTRY FURNITURE</b> Channel Master TV Antenna Systems Repair &amp; Replacement Call Day 427-3227 Or Night 427-2326</p>	<p><b>HIGGINS COUNTRY FURNITURE</b> Buy And Sell USED FURNITURE APPLIANCES ANTIQUES 427-3227 HWY. 37 S CLARKSVILLE</p>



# Johntown News

By Eva Weisinger

Mr. and Mrs. David Potter, Chris Potter and Mr. and Mrs. D.C. Thomas and grandson Donnie Thomas joined Mr. and Mrs. David Stevens and girls of Cropsus Christi, Mr. and Mrs. John Fortner, Kristi and Kimberly, Mr. and Mrs. George Green of Mt. Pleasant for Thanksgiving dinner in the home of Mr. and Mrs. Darrel Green of Mt. Pleasant Thursday.

Mr. and Mrs. Morris Parker accompanied Mr. and Mrs. J.T. Sells to Big T Cafe in Mt. Pleasant for lunch Sunday. They had an afternoon drive through parts of Titus, Franklin, Hopkins and Red River Counties.

Dana and Crystal White spent the weekend in Clarksville with their father, Mr. and Mrs. Patrick White.

Dinner guests of Mr. and Mrs. Boots Roberts Thanksgiving day were Mr. and Mrs. Timmy Hiltzman, Chris and Clay, Mrs. Patsy Collins of Longview, Mr. and Mrs. Howard Potter and Mr. and Mrs. Burl Duffie. The Hiltzman family and Mrs. Collins were overnight guests. Mrs. Hiltzman, Mrs. Collins and Clay returned Friday and Mr. Hiltzman and Chris remained until Sunday evening.

Mmes. Buford Hood, Drue Pirtle and Gene Hawkins attended open house at the Carosel in Clarksville Sunday afternoon and Open House at Micky's Flower Shop also.

Mrs. Doshie Jones and grandson Tony Rosler returned from Childrens Medical Center in Dallas Saturday where Tony had a series of treatments. They got a good report on Tony's condition.

Dinner guests of Mr. and Mrs. Roger Weatherall and girls were Mr. and Mrs. Johnny Weatherall and Mrs. May Wall of Talco.

Those having Thanksgiving dinner in the home of Mr. and Mrs. Lennie Wicks were: Mr. and Mrs. Thomas Wilder; Mr. and Mrs. Buck Isbell, Mr. and Mrs. Roy Anderson and son Mickey; Mr. and Mrs. Harvey Anderson and Kathy; Mr. and Mrs. Franky Anderson all of Mt. Pleasant; Mrs. Dorothy Mauldin of Carrollton. Afternoon visitors were Mr. and Mrs. Buddy Lawson and Mrs. Fern Gibbs and sons of Bogata and Mr. and Mrs. Bobby Simmons of Cuthand.

Friday visitors of Mr. and Mrs. Rufus Williams were Mr. and Mrs. Bill Cummings of Dallas.

Mr. and Mrs. Ron Graham, Jamin and Jerah visited her grandparents in Arkansas through Thanksgiving holidays. Her parents Mr. and Mrs. Elvis Dollar of Lrain, Ohio joined them in Arkansas for a visit with relatives also.

Guests in the home of Mr. and Mrs. Drew Pirtle, Lana and Clay for Thanksgiving dinner were: Mr. and Mrs. Ed Pirtle and Todd of Beaumont; Vance Pirtle of Texarkana; Mrs. Myra Jean, Darla and Dale, Mr. and Mrs. Donald Jean and Mitch, Mrs. Dana Anderson and Mr. and Mrs. Buford Hood.

The evening meal was smoked deer prepared by Dale Jean with added trimmings.

Mr. and Mrs. Howard Potter spent Sunday night with their son Carlos Potter in Kaufman. Monday they were in Dallas to visit their son Ray Potter and were overnight guests. Returning home Tuesday.

Mrs. Nell D. Rhodes' guests for dinner Thanksgiving day were Mrs. Joyce Rhodes and daughter Tommy of Lone Star, Mr. and Mrs. Rainey McKinney, Mrs. Gary Howard and daughter Cindy, Scott and Jason Johnson of Bogata, Joel and Ryan Bryant of Fresno, California.

Mr. and Mrs. Dale Rhodes of Rivercrest Trails and Mrs. Tommie Nichols of Mt. Pleasant. Mr. and Mrs. Junior Black and Mrs. Nancy Coffman of Ft. Worth and Mrs. Elsie Tolliver of California visited Mr. and Mrs. Linnie Wicks Saturday afternoon.

Mrs. Dorothy Stevens was admitted to Titus County Memorial Hospital Tuesday and was dismissed Thursday due to a light heart attack.

Mr. and Mrs. Ed Pirtle, and Todd of Beaumont visited their daughter, Mr. and Mrs. Bryan Harville, his mother and dad, Mr. and Mrs. Morris Parker and her sister, Mr. and Mrs. Drew Pirtle Lana and Clay and other relatives in the Bogata area through Thanksgiving holidays.

Visitors of Mr. and Mrs. George Kepler Thursday morning were Mr. and Mrs. Bobby Lamb of Sunnyvale, Mr. and Mrs. Billy Ogg, Loy Dean Aldridge and daughter Mandy of Bogata and Dorothy Foster.

Guests of Mrs. Marie Crafts for Thanksgiving dinner were Mr. and Mrs. Lester Henderson, Michelle Hauson and children of Pleasant Grove, Mr. and Mrs. Dale Kidd and Mr. and Mrs. Robert St. Jacques of Mesquite, Mrs. Margaret Newsome and Amanda of Mt. Pleasant and Mr. and Mrs. Ted Jordan and children of Bridges Chapel. Mr. and Mrs. Kidd were overnight guests returning home Friday.

Mrs. George Kepler, Mr. and Mrs. Don Barnard and children and Marie Crafts and Shawn attended the funeral of Mrs. Mauda Condra in Clarksville Saturday afternoon.

Glenda Cox of Commerce and Mr. and Mrs. Eugene Cox, David, Angela and Lori of Bogata were dinner guests of Mr. and Mrs. Tommy Lee Cox Thanksgiving day. Mr. Donald Wilson of Bogata came for a visit in the afternoon.

Visitors of Mr. and Mrs. Stanley Welesiak the past week were her daughter and son in law, Mr. and Mrs. Marvin Steward of Wellington, Richey Winkler and friend Lisa Swinford of Denton were house guests from Wednesday until Sunday.

Mr. S.C. Jenkins of Corpus Christi was a dinner guest of Mr. and Mrs. Gene Hawkins Tuesday. He also visited other friends and relatives in the Bogata area.

Kami and Claudia Cope spent from Thursday until Saturday with their grandparents, Mr. and Mrs. Grady Dodd and Mr. Casey Watts.

Guests of Mr. and Mrs. Gaylon Eudy from Thursday until Saturday were Mr. and Mrs. Richard Eudy of Savannah Georgia.

House guests of Mrs. Arietta Hervey this weekend were Larry Hervey of Garland and a friend, Cindy, of Ft. Worth.

Mr. and Mrs. Bob Hancock, Robert Smith and Jay Hancock visited Bobra Montgomery and Randy Hancock in Garland Friday and Saturday.

Joe Hervey of Midlothian visited his parents Mr. and Mrs. Sammy Hervey from Wednesday until Tuesday.

Guests in the home of Mr. and Mrs. M.L. Beakley Thanksgiving Holidays were LaTricia Belcher of Cuthand, and Carla Roberts of Orange.

Jan McCuller of Mt. Pleasant visited her mother, Mr. and Mrs. Ed Childers Friday.

Mr. and Mrs. S.E. Dodd, Russell and Melissa visited Mr. and Mrs. Newton Loyd and Mrs. Mamie Matthews of Pittsburg Saturday and returned Sunday.

Mr. and Mrs. Bob Hancock, Robert and Jay joined Mr. and Mrs. DeWayne Benson and children of Clarksville and Mr. and Mrs. Donnie Smith and Dorie of Bogata for Thanksgiving dinner in the home of their mother Mr. and Mrs. Raymond Mauldin of Bogata.

Jess D. Evans of Mt. Vernon visited Mr. and Mrs. Tommy Lee Cox Saturday afternoon and Mr. and Mrs. Burl Elliott of Portales, New Mexico visited awhile Monday morning.

Those enjoying Thanksgiving dinner in the home of Mr. and Mrs. Cleo Northcutt were: Mr. and Mrs. M.E. Parr and Mr. and Mrs. Dinnis Winkler, Michelle and David of Bogata, Mrs. Lucille Beakley, James Strickland, Carla Roberts of Orange and LaTricia Belcher of Cuthand. Mr. and Mrs. Stanley Waleziak, Mr. and Mrs. Marvin Steward, Richey Winkler and friend Lisa of Denton.

Mr. and Mrs. Rober Weatherall, Krista and Jana joined them in the afternoon for a visit.

Saturday dinner guests of Mr. and Mrs. Drew Pirtle were Mr. and Mrs. Ralph Cawley and Kristi, Mr. and Mrs. Ed Pirtle and Todd of Beaumont and Mr. and Mrs. Bryan Harville.

Mr. and Mrs. Bo Wilson were in Humble to visit their son Mr. and Mrs. Colden Wilson, Josh and Colen from Thursday until Sunday.

Mr. and Mrs. Jerry Rhodes of Clarksville were dinner guests of Mrs. Jo Wilson Sunday.

Amy and Nicole Hervey of Bogata spent the weekend with their dad, Mr. and Mrs. Butch Hervey and Amanda.

Mr. and Mrs. Drew Pirtle hosted a fish fry at their home Friday. Guests were the Roachs, Mr. and Mrs. Mildred Roach, Mrs. Molly Ann Williams, Mandy and Marla of Bogata, Mr. and Mrs. Bryan Harville of Johntown, Mr. and Mrs. Ed Pirtle and Todd of Beaumont, Brad Davidson of Rivercrest Trails, Mrs. Ruby Parker, Vance Pirtle, Mr. and Mrs. Buford Hood, Mrs. Dana Anderson, Mr. Donald Jean and Mitch, Mrs. Myra Jean, Dale and Darla and Lana and Clay Pirtle.

Those who had Thanksgiving dinner at the home of Mr. and Mrs. Grady Dodd were Mr. and Mrs. Kenneth Jeffery and Casey, Mrs. Tracy Guest of Bogata, Britt Davenport of Pine Branch, Mrs. Terry Cope and daughters, Kami and Claudia of Paris, Jace Jeffery, Eddie Dodd and friend La Nal Lambert of Dallas and Casey Watts of the home.

Miss Bobbie Cotes of Tulsa spent from Thursday until Saturday with her mother and brother, Mrs. Lois Cotes and Byron Ray. Thanksgiving dinner guests of Mrs. Cates were Mrs. Louise Wonik of Corinth, Mississippi, Mr. and Mrs. John Cates of New Braunsville, Bob Cates of Detroit, Mr. and Mrs. Donnie Howard of Mt. Pleasant and Mr. and Mrs. Harold Mangrum of Longview.

Mr. and Mrs. Danny Black's guests for Thanksgiving dinner were: Mr. and Mrs. Grady Rhodes, Mrs. Jo Wilson of Johntown, Mr. and Mrs. Jerry Rhodes of Clarksville, Kristi Eudy of Talco and Dena, Chrystal, and Pat of the home.

Mr. and Mrs. Bobby Lamb of Sunnyvale visited Mr. and Mrs. Ed Childer Thursday afternoon. Dinner guests of Mr. and Mrs. Sammy Hervey Thanksgiving day were Joe Hervey of Midlothian, Mr. and Mrs. Ricky Franks and Clint of Talco, Mr. and Mrs. Butch Hervey, Amy and Nicole and Amanda Conway and Mrs. Arietta Hervey.

Mr. and Mrs. Dan Cotten of Midland, Miss Janice Davis of Dallas, Mr. and Mrs. Jim Davis of Talco and Miss Vera Cotten of Red River Haven Nursing Home, Bogata, were guests of Mrs. Pokie Whitby and Jimmy Cotten for Thanksgiving dinner Thursday.

Mr. and Mrs. Jimmie Weisinger, Lisa, John and Leslie of Longview and Mr. and Mrs. Royce Weisinger and daughter Robin of Bedford were dinner guests of Mr. and Mrs. R.W. Weisinger Friday. Royce and family were overnight guests and returned home Saturday afternoon.

Bro. and Mrs. Billy Daniels, Mr. and Mrs. Ricky Daniels and Jamie and Mr. and Mrs. Tim Daniels of Commerce visited in Grand Saline with Mr. and Mrs. Fred Daniels and Mr. and Mrs. D.B. Carter during Thanksgiving holidays.

Le Ann McCuller and ERin of Mt. Pleasant and Mr. and Mrs. Dennis Elliott of Longview, Mr. and Mrs. Keith House of College Station were dinner guests of Mr. and Mrs. Dale House and Shane Compton. Friday Keith and Robin visited in the Bogata and Johntown area from Wednesday until Sunday.

Mrs. Barbara Kelly, Keith, Kenneth and Kimberly spent Thanksgiving day in Mabank with her parents, Mr. and Mrs. Luther Lynch.

Mrs. Ora Pirtle visited her daughter and family, Mr. and Mrs. David Hudson, April and Vance of Nocona the past week. Mr. and Mrs. Mark Hudson and children of Wax-

ahachie were also visitors in the home while Mrs. Pirtle was in law. Mrs. Pirtle returned home Monday.

Mrs. Ruth Colquhoun of Mesquite spent Thanksgiving with Mr. and Mrs. Morris Parker.

Mr. and Mrs. Melvin Steward of Avenger and Mr. and Mrs. Calvin Bass of Talco were dinner guests of Mr. and Mrs. Ronie Steward, Janie and Ronnie Lee Thanksgiving.

A pre-Thanksgiving dinner in the home of Mr. and Mrs. Marcus Allus Wednesday evening was enjoyed by Mr. and Mrs. Travis Watts, Mr. and Mrs. George Allums and Jerry, Mr. and Mrs. Monte Allums and Krisha, Mrs. Ray Alford, Bubba and Lori of Bogata, Mr. and Mrs. Gerald Erbackard Charisse and Erick of Sunnyvale. The Erback family were overnight guests.

Brandy and Brandon Jagers spent from Thursday until Sunday afternoon with their grandparents, Mr. and Mrs. T.A. Jagers of Mt. Pleasant.

Mr. and Mrs. Jackie Geers of Odessa spent Thanksgiving with her sister and brother in law, Mr. and Mrs. Bill Dodd and Stacy.

Saturday, November 23 Jimmy Wyche of Arlington brought his mother Mrs. Nancy Wyche and sister Nancy and her son Matthew of Mill Creek, Washington to visit her parents, Mr. and Mrs. Lewis Herring. Jimmy was an overnight guest and returned home Sunday. Mrs. Wyche, Nancy and Matthew remained until Thursday.

**DID YOU KNOW?** *By Javis*

**FORMER U.S. PRESIDENT DWIGHT EISENHOWER WAS A PRETTY FAIR OIL PAINTER BUT HE COULDN'T DRAW VERY WELL, SO AN ARTISTIC SOLDIER SKETCHED SCENES ON CANVAS FOR IKE TO PAINT OVER.**

**PASSENGER PIGEONS**  
WERE FOUND IN THE EASTERN UNITED STATES UNTIL THE END OF THE 1800's, IN SUCH LARGE NUMBERS, IT WAS REPORTED BY JAMES AUDUBON THAT A FLOCK OF THEM TOOK 3 DAYS TO FLY BY, AND THEY DARKENED THE SKY! BUT HUNTERS' GREED CAUSED THEIR EXTINCTION. THE LAST KNOWN ONE DIED IN 1914, IN A CINCINNATI ZOOLOGICAL GARDEN.

**SAM RAYBURN**  
OF TEXAS SERVED AS SPEAKER OF THE HOUSE OF REPRESENTATIVES LONGER THAN ANYONE.

**IN 1539 HERNANDO DE SOTO BROUGHT THE FIRST PIGS TO AMERICA. HIS ORIGINAL HERD OF 13 DEVELOPED INTO RAZOR-BACKS WHICH RUN WILD.**





**YOU CAN COUNT ON US...**



**WE'RE YOUR FRIENDS!**

Now that you have met all the friendly folks at First National Bank, come on in and let us help you set up the program that best suits your needs: Passbook, IRA, checking account, or whatever your needs may be.

We are here to help you in any way that we can.

**FIRST NATIONAL BANK**  
**IN BOGATA** **FDIC**

**American Viewpoints**



The only way to have a friend is to be one.  
*Ralph Waldo Emerson*



have a nice weekend

## Straight Talk

from Texas-New Mexico Power Company

**Why did TNP Employee Don Beauchamp make his home an Energy Checked Efficiency Home?**

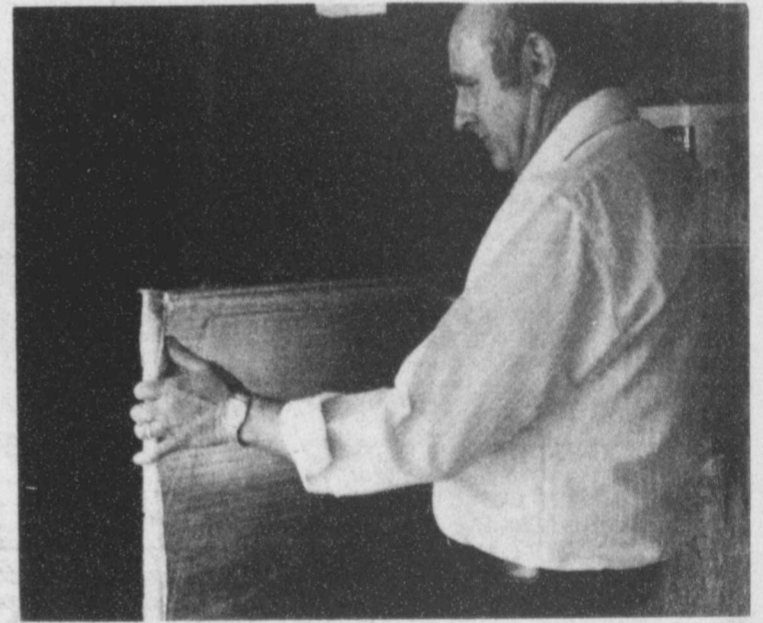

TNP Employee Don Beauchamp of Pecos, Texas, examines some insulation which helps to make his home energy efficient.

TNP Employee Don Beauchamp knows that squeezing the most benefit from your electric service is a lot easier when you make your house an Energy Checked Efficiency Home. Energy Checked Efficiency Homes have been inspected to have many of the features that help you retain the indoor comfort that you're paying for. Adequate insulation of the recommended "R" value, energy efficient heating and cooling equipment, and storm doors and windows are only some of the features of a home that is made to be comfortable year 'round and energy efficient at the same time. If you're building, buying, or remodeling your home, find out all the details of making your house an Energy Checked Efficiency Home. Call our office today!

**Neighborly Professionals**  
**Offering You The Best Choice**



**Texas-New Mexico Power Company.**

EL-47-85

### J. P. HARVEY MOTORS

427-2241 700 EAST MAIN CLARKSVILLE 427-2296

**Now Offering GMAC Direct LEASING 1986 Chevrolet Lease Special SPRINT 5 Door Hatchback**



**Air Conditioning Am/FM Stereo 5 Speed Tinted Glass Tachometer Rear Window Defrost Comfort & Convenience Group \$196<sup>15</sup> Per Month**

**48 Month Closed End Lease With Option To Purchase At Fair Market Value At End Of Lease - 1st Payment Of \$196.15 And \$200.00 Security Deposit Required In Advance -**

**Total Lease Payment \$8935.20, .06 Cents Per Mile Over 72,000 Miles, Registration Fees And Taxes Included.**





**STUDENTS OF THE Month** for November are Ricky Kennedy and Kelly Anschutz. Kelly, daughter of Tony and Jo Anschutz of Talco, is a senior. She is a member of Rebelette basketball and annual

staff. Ricky is the son of Ricky and Sharon Kennedy of Bogata and is a member of the FFA, Student Council and NHS and a senior at Rivercrest. (Staff Photo by Diana Eudy)

## Wilkinson News

Katherine and Jusitn, Jimmy Dean and Mary Graft and Jason, Rhonda Johnson, Carey and Kenneth. Rhonda Johnson was also celebrating a birthday.

Mr. and Mrs. Joe Herrera and Jaime of Tyler were Sunday guests of Mrs. Virgie Graf.

Mr. and Mrs. James Logan and Brenda, Mr. and Mrs. David Logan and Brandon of Ft. Worth visited Mr. and Mrs. L.R. Bell.

Elizabeth Gaston, Wendy Ragsdale and Kari of Terrell visited Mr. and Mrs. Wesley Blalock and Bryant. Mrs. Blalock accompanied by her daughter, Liz, visited in the home of her mother, Eunice Winkle on Thanksgiving.

Mr. and Mrs. Ronnie Logan and Galen spent Thanksgiving with her sister, and family. Mr. and Mrs. Ben Thompson of Irving. Also visiting in the Thompson home were Mr. and Mrs. J.H. Byram and Barbara. Mr. and Mrs. Joe Rex Thompson and Mr. and Mrs. Wendell House.

Thanksgiving guests of Mrs. Lillian Thompson were Ed Thompson, Helne Reynolds and children, Eddie Joe Thompson and friend, Michelle, Mr. and Mrs. Jerry Thompson and children, Nancy Chancellor and Laura, Mr. and Mrs. Harlin Ratliff and baby, Mr. and Mrs. Johnny Thompson, Tim and Kendall, Mr. and Mrs. Luke Thompson.

Mr. and Mrs. Everette Logan Jr.

and Jeremy, and Mr. and Mrs. David Logan and family visited Mrs. Ella Boehme of Mabank on Friday.

Visiting in the home of Mr. and Mrs. Everett Logan, Sr. for Thanksgiving were Mr. and Mrs. Everette Logan, Jr., Mr. and Mrs. Gary Logan, Mr. and Mrs. David Menasco and children, and Mr. and Mrs. David Logan.

Mrs. Alvin Blalock was involved in an automobile accident on Friday on Harts Bluff road. Fortunately Mrs. Blalock was not injured.

The Wilkinson Community Center held its regular monthly meeting Monday night. Next scheduled meeting is for January 6, 1986.

A covered dish supper will be served



## Drivers Ed Course Set

Paris Junior College's next driver education course will begin Monday, Jan. 6, but reservations for the course are due Dec. 20 when PJC closes for the Christmas holidays.

The course was held in October and November, but no December classes were scheduled because of the holidays, said June Jones, director of community services. Driver education includes required classroom hours, observation and driving hours needed to obtain a driver's license. It is open to anyone 15 years of age or older, Mrs. Jones said.

Classes will be held from 4 to 6 p.m. Monday through Friday, beginning Jan. 6 in the Alford Center at PJC. The course includes 32 hours of classroom instruction, and observation and driving is scheduled with the individual student. Fee is \$145.

Instructor is James E. Jones, retired Paris Independent School District driver education instructor.

Reservations must be made by paying the fee in the Alford Center at PJC by Friday, Dec. 20. Checks payable to PJC may be mailed to the Community Services office, PJC by that date. Classes are limited so reservations should be made early.

Other classes are scheduled to begin the first of each month. More information may be obtained by calling 784-9445 or 784-9447.

## Work Planned To Protect Roads

While Texas' roadways are suffering under the winter's storms, highway department engineers are already planning work that will help protect road surfaces next winter.

The State Highway and Public Transportation Commission approved a \$2.3 million seal coat contract for nearly 60 miles of roadway in five northeast Texas counties. The contract was awarded to Duinick Brothers and Gilchrist Company and is funded through the highway department's safety and betterment program, which received a boost recently when highway funding was increased.

Seal coat preventative maintenance programs provide a protective layer of asphalt over the highway's surface, according to Billy Rogers, a highway department design engineer. The procedure helps

prevent the formation of potholes, which occur when the ground under a highway surface freezes and expands.

More than 15 miles of highway in Lamar County, eight miles in Hopkins County, 11 miles in Franklin County, approximately three miles in Fannin County and nearly 20 miles in Red River County will be included in the project. Several miles of US 271, US 82 and Texas 37 are the primary roadways to be coated.

Roy Tomblin, an engineering technician with the Paris highway district, said the roadways were among the more heavily traveled arteries in the area. A number of people commute to major firms in Paris along those highways, he said. Tomblin said the project will be completed between April and July of 1986.

## Christmas Opera To Be Presented At PJC

Amahl and the Night Visitors, a colorful production of Gian-carlo Menotti's one-act opera will be presented by the Paris Junior College Fine Arts Division on December 6, 7 and 8, according to Ray Karrer.

The production is scheduled for 7:30 on Friday and Saturday and at 3 p.m. on Sunday in the Theater for the Performing Arts at PJC. Tickets are priced at \$4 general admission and \$2 for students except PJC students who are admitted free. They go on same Nov. 25 in the College Store.

The well known opera concerns the Three Wise Men's unscheduled visit in the home of a crippled shepherd boy and his poor windowed mother. A heart-warming production, it has been viewed by millions since the first NBC performance on Christmas Eve of 1951.

"I decided to present the Christmas story this year because the college has

quality drama students who are capable of filling the roles," Karrer explained. "It is a challenging score and a wonderful Christmas story for children and adults alike."

Karrer will be the director, and Lon Chaffin will direct the orchestra and chorus for the production. John Wright is scene and technical director, and Jennie Vaughan is rehearsal accompanist. A 10 or 12 member orchestra will be composed of community residents and professionals.

PJC and North Lamar High School students will be chorus members and dancers.

"There hath not failed one word of all his good promise."  
1 Kings 8:56b

**GRANDCHILDREN OF THE WEEK**

**Bradley & Brandi Cecil**

Children Of Steve & Ginger Cecil Of Paris. Grandparents Are Mrs. Reba Cecil Of Talco And Mrs. Lawanda Merritt Of Pattonville. Great-Grandparent Mrs. Florence Pirtle Of Johnstown.

This Salute Sponsored By  
**BOGATA FUNERAL HOME**

**Jim Walter HOMES**  
ANNOUNCES ANOTHER BIG  
**OPEN HOUSE!**

You, too, can own a new home, the easy, Jim Walter way. INSTANT MORTGAGE FINANCING TO QUALIFIED PROPERTY OWNERS. If you can't attend but would like information about building on your property, please mail the coupon or write today.

**10% FIXED MORTGAGES**  
ANNUAL PERCENTAGE RATE  
**NO DOWN PAYMENT**  
TO QUALIFIED PROPERTY OWNERS

**FREE DRAWING**  
A "PLEASER" KODAK INSTANT CAMERA with film will be given to some lucky person. Refreshments will be served. Gifts for the entire family.

**Ms. Dorothy Satterfield**  
Cordially invites you  
to attend the open house being held at her new home on this  
Saturday & Sunday  
December 7 & 8, 1985

**DIRECTIONS**  
In Bogata, at Jim's Corner Grocery on FM 909, take Hwy. 1487 North 5 Miles to Open House.  
You will see the Open House Signs.

**FREE FULL-COLOR CATALOG!**  
JIM WALTER HOMES (Mail to nearest office)  
I would like to have more information and the cost of building on my property. I understand there will be no obligation to buy and that you would give me these facts free of charge.

NAME \_\_\_\_\_  
ADDRESS \_\_\_\_\_  
CITY \_\_\_\_\_ STATE \_\_\_\_\_ ZIP \_\_\_\_\_  
Telephone (or neighbors) \_\_\_\_\_  
If rural route please give directions \_\_\_\_\_  
I own property in \_\_\_\_\_ County.

**Jim Walter HOMES**  
Our Display Parks are open Saturday and Sunday for your convenience  
2930 N. Main Street P.O. Box 631  
(On 271 North of Loop)  
Paris, Texas 75460  
214/785-7641

**GE**

**YOU'LL THINK IT'S MAGIC!**

You Get Arm Chair Control of VCR

**PRICE \$379<sup>95</sup>**

**VHS REMOTE CONTROL VIDEO CASSETTE RECORDER**  
MODEL IVC 6018 X

- Multi-function wireless Remote Control
- Four event/14 day programming
- Special Effects — video scan, slow motion, pause
- "Cable Connection Ready" for increased flexibility
- Timer protected from power failures
- Tape counter memory
- One-Touch recording up to 4 hours
- Electronic VHF/UHF tuner with 107 channels

**GE. WE BRING GOOD THINGS TO LIFE.**  
WE SERVICE WHAT WE SELL  
Free Delivery

**WOOLDRIDGE HOME APPLIANCES**

2429 Clarksville Paris 785-1324



## Talco Locals

Mr. and Mrs. Clarence Watts of Talco and Mrs. Ann Brown of Daingerfield spent Thanksgiving Day with Paul Sullivan of DeKalb.

Approximately 65 members of the First Baptist Church stayed after church Sunday night to give their new pastor, Bro. Gary House and family and Old Fashioned Pounding. They were also presented a Christmas bonus. Refreshments of cookies, cake, punch, coffee and cold drinks were served.

Thanksgiving Day guests in the home of Mrs. Ruby Lorraine were her children, grandchildren and friends. Mr. and Mrs. Jimmy Lorraine and family of Austin, Mr. and Mrs. Rocky Bidle and family of Rockwall, Mr. and Mrs. Geo. Beatty and family of Pittsburg, Mr. and Mrs. Ennis Brown and family, Mr. and Mrs. McBride and family, Robert Brown, all of Talco and Cecil Johnson of Monticello.

Mr. and Mrs. Dan Morgan returned home Monday after two weeks in Dallas with her father, Geo. Hinson while waiting on the arrival of a new grandson, Cody Wayne Wilbanks, born on Thanksgiving day.

Mrs. Georgia Easterling had all her children home for Thanksgiving. They were: Mr. and Mrs. Ray Kelley of Plano, Mr. and Mrs. Bill Walls, Christopher, Billy and Billy's friend, Tandy Priest, all of Tyler; Mr. and Mrs. Lank Easterling, Jon, Jason and April of Amarillo. Mr. and Mrs. Donald Easterling, and Billy Hightower, Talco and Jimmy Lorraine of Austin visited during the afternoon.

Thanksgiving weekend guests in the home of Mr. and Mrs. Wayman Alexander were their children and grandchildren, Mr. and Mrs. Bill Chapel of Houston, Mrs. Don Mewborn, Lea and Shelly of Mineola and Mrs. Alexander's mother, Mrs. Gladys Garretson of Talco.

Mr. and Mrs. Russell Foxworthy and Nicki accompanied by her mother, Mrs. Orva Lou Easterling attended the wedding of Mr. Foxworthy's niece, Linda Davis to Robert Cooley at the Red Ball Methodist Church in New Boston Saturday night. Miss Davis is the daughter of Mr. and Mrs. Dewey Davis of Avery. The groom's parents are the Rev. and Mrs. Cooley of New Boston.

Nancy Presley of Dallas was a recent visitor in the home of her mother, Mrs. Jeff Ewing and Mr. Ewing.

Mr. and Mrs. Dailey Brown of Edmond, Oklahoma, spent from Tuesday until Saturday with their niece and her husband, Mr. and Mrs. Lester Watts. Other Thanksgiving day

guests were Mr. and Mrs. Clarence Watts, Tawala and Jesse, Mrs. Ann Brown of Daingerfield and Nathan Hinson of Joliet.

Thanksgiving Day guests in the home of Mr. and Mrs. Ted Ewing were his father and wife, Mr. and Mrs. Jeff Ewing of Talco, her parents, Mr. and Mrs. Walker, Brenda, Keith and Brandon of Texarkana and Fredrick Weisinger and two daughters of Clarksville.

Doug and Gayle Miller with their children, Rebecca and Aaron of Lake Jackson and K.C. and Linda Reidy and Andy Ryle of Irving were Thanksgiving Day guests in the home of Dr. and Mrs. E.L. Miller.

Mr. and Mrs. Dan Cotten of Midland and Miss Janice Davis of Dallas spent Thanksgiving holidays with their parents, Mr. and Mrs. J.A. Davis.

Alfred Westerman of Buras, La. was a recent guest in the home of his parents, Mr. and Mrs. Hulen Westerman. The Westerman's daughter and husband, Lloyd and Penny Boudreaux of Buras, La., John David, Jena and Attela Westerman of Camden, Arkansas were Thanksgiving Day guests.

Mrs. L.R. LeMay reported that their grandson and wife, Jimmy and Earlene LeMay and great-grandson James Wesley of Houston visited her and Mr. LeMay during the Thanksgiving holidays. They spent most of the time with Jimmy's father J.L. LeMay who is very ill at his home in Mt. Pleasant. J.L. would enjoy visits from his friends in the Talco area.

Thanksgiving Day dinner guests in the home of Mr. and Mrs. Russell Foxworthy and daughters were realtives and friends Mrs. Rosa Lee Ottinger, Mr. and Mrs. Wayne Blalock, Michael Clark, Wendy Clark, Julie Riddle, Mr. and Mrs. Jim Simpson and three girls, Craig Clemons, Sammy Joe Wilkinson and Mrs. Orva Lee Easterling all of the Talco area.

Thanksgiving day guests in the home of Mrs. Dona Pittman and Verbeth Wyatt were Mrs. Pittman's children and grandchildren, Mr. and Mrs. Bill Austin of Dallas, Mr. and Mrs. Bill Smith, Mt. Pleasant, Alfred Westerman, Buras, La., Mr. and Mrs. Jesse Brown, Mr. and Mrs. Raymond Pittman, Mr. and Mrs. Hal Strahan and Thlma Westerman all of Talco. Gray Pitts and Friend Terri of Mt. Pleasant, Randy and Mona Pitts and Charlene Black, Talco, visited in the afternoon.

Holiday guests in the home of Mr.

and Mrs. Mack Black were Mr. and Mrs. Frankie Joe Harrell of Dallas, Mrs. Jackie Kirkland Justin and Jolie of Mt. Pleasant, Mr. and Mrs. Danny Black of Joliet and Bobby Crawley of Dallas.

Mrs. W.C. Fry returned home Tuesday after spending the week with her grandchildren, J.W., Cassie and Jeromia of Whitehouse while their parents, Mr. and Mrs. Jackie Stinson were in San Antonio to attend a DPS Officers Association meeting. Jackie and the children came Wednesday to spend Thanksgiving with the Frys and his wife Katy joined them on Friday. They all attended the Thanksgiving supper at the Maple Springs Baptist Church pavilion Friday night. Approximately 30 were there. Jackie Stinson and children visited Mr. and Mrs. C.D. Brown in Mt. Pleasant.

Twelve W.M. ladies of the Assembly of God Church met Monday night in the church fellowship hall for a salad supper and to draw secret names for the coming year. Those attending were Mmes. Patsy Watts, Marilyn Presley, Vivian Fail, Ruth Hanks, Bernice Baldwin, Dona Hearron, Charlett Brumbalow, Grace Hearron, Thelma Walker, Rosie Brown, Nora Hearron and Brenda Smith.

Mr. and Mrs. Wayman Alexander and Mrs. Gladys Garretson were dinner guests in the home of Mrs. Elizabeth Garretson at Mt. Vernon Thanksgiving Day.

Mrs. Florence Richardson and Mrs. J.J. Smith have returned home after they visited their children in the Dallas area for ten days. Mrs. Richardson visited her two daughter, Mrs. Margarie Taylor and children of Dallas and Mr. and Mrs. Jim Foster and family of Garland. Mrs. Smith visited her daughter, Mrs. Mary Ruth Sikorski of Dallas. They spent Friday night with Mary Ruth's son, Tommy Sikorski and family of McKinney.

Mr. and Mrs. J.C. Fail left Thursday afternoon to go to Frankston where they visited their son and family, Mr. and Mrs. Jimmy Fail, Loretta, Bo and Jeremy. Enroute home Sunday they visited Mrs. Lucille Fail Moore and Wayne in Gladewater.

Mr. and Mrs. Clifford Jones visited her parents, Mr. and Mrs. J.O. Carlisle in Athens Friday and Saturday. Jerry Whitney of Corpus Christi visited during the Thanksgiving holidays with his mother, Mrs. Lula Whitney and brother, Dumas. They spent Thanksgiving Day with another brother and his wife, Mr. and Mrs. Albert Whitney of Mt. Pleasant.

Mrs. Charlotte Goodson and Woody spent Thanksgiving with her parents,



ALL DISTRICT Football-Rivercrest players chosen for the All District team are, not in order: Tony Jasso, first team flanker and second team secondary; Chris Anderson, second team split end; Bubba Simpson, first team running

back; Jerry Belcher, second team running back; Bradley Woods, first team quarterback and second team secondary; Rusty Screws, first team offensive guard; Bobby Williamson, second team offensive tackle; Shane Wright, second team defensive

lineman (not shown) and Wade Smith, first team secondary (not shown). Bradley Woods was named Newcomer of the Year. These players were nominated by their coaches and voted on by the other coaches in the district. (Staff Photo by Diana Eudy)

## S&WCD Accepts Teacher Nominations

Nominations are being accepted for the national "Conservation Teacher of the Year" awards program according to James E. Pearce, Chairman of the Red River County Soil and Water Conservation District. The competition is open to all full time teachers working at the kindergarten through high school level who have developed an outstanding program of conservation education.

The National Conservation Teacher of the Year will receive \$1,000 in cash and an expense paid trip to Reno, Nevada for the 1987 annual convention of the National Association of Conservation Districts. The national second place winner will receive a \$500 cash award and the first place regional winner will receive \$200.

Co-sponsored by NACD and the Deutz-Allis Corporation, the purpose of the awards program is to encourage the development of creative learning experiences in conservation for young people. "Any teacher in a public or private school in our conser-

vation district who puts emphasis on conservation as a regular part of the instructional program is eligible for nomination," said Pearce.

Interested teachers can obtain additional information and nomination forms from the Red River County S&WCD, phone 427-2975. The awards program also honors the conservation districts judged to have provided the most effective stimulus and help for conservation education programs within the district.



Mr. and Mrs. R.W. Sanders and with her son, Mr. and Mrs. Rick Sparks and two daughters of Henderson

Thanksgiving Holiday guests in the home of Mr. and Mrs. Charley Roberts were Mr. and Mrs. Mack McLemore and children Kevin, Kirk and Kara of Plano and Mr. and Mrs. Mike Mauldin and Charles Robert of Lufkin.

Mrs. Fannie Moore of Mt. Pleasant and Mrs. Nell Joyce of Winfield visited Mrs. Joyce Alexander Monday afternoon.

Mr. and Mrs. Duane Welch of Pasadena were Thanksgiving holiday visitors in the home of his parents, Mr. and Mrs. Elton Welch.

Alice Ruth Tidwell spent Thanksgiving Day in the home of Mr. and Mrs. Bob Fitch and Susan and Mrs. Naomi Fitch of Bridges Chapel.

"God is our refuge and strength, a very present help in trouble." Psalm 46:1

# Christmas Bargain Days

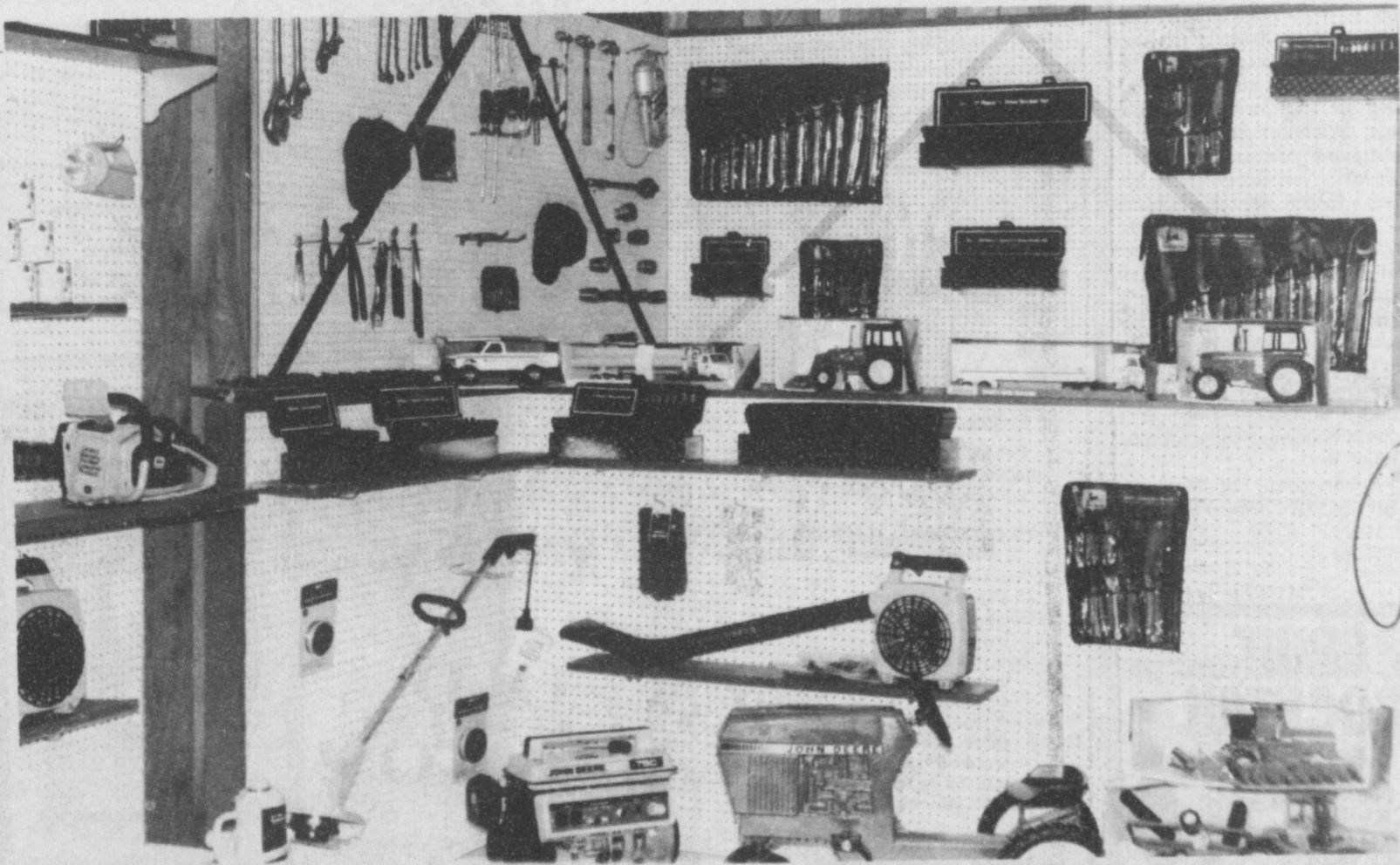

**TOYS**  
For The Kids  
At The Best **PRICES**  
In Town

**TOOLS**  
For Dad With A  
Life Time Guarantee

**MOWERS & LAWN Care Equipment For The Home**

OPEN MONDAY -FRIDAY 7:30 A.M. - 5:30 P.M.  
SATURDAY 7:30 A.M.- 12:00 Noon



## Agri - Line Equipment, Inc.

### John Deere Service Center

Hwy. 37 South

Clarksville, Texas

427-5638



# Bogata Locals

Enjoying Thanksgiving lunch with Myrtis and Raymon Mauldin Thursday were their children, Mr. and Mrs. Bob Hancock, Jay Hancock and Robert Smith of Rivercrest, Mr. and Mrs. Duane Benson, Jayson and Kim of Clarksville, Mr. and Mrs. Donnie Smith and Dorie of Bogata.

Kim Benson of Clarksville visited from Thursday until Sunday with Dorie Smith in Bogata.

Visiting Josie Fennell over the weekend were Mr. and Mrs. Lowrance Thompson and children of Odessa, Connie Chapman of Odessa, Era Lee Hamilton and Jo Ann of Irving, Marla Floy Littles of Dallas and Mr. and Mrs. A.W. Harville, Kenneth and Allan of Hurst.

Harold Mathena and his son, John, of Bethany, OK visited Mr. and Mrs. Ralph Harbison over the weekend.

Weekend visitors of Mrs. Vola Ward were Mr. and Mrs. Bill Hook and children of El Dorado, Mrs. Tina Westbrook and children, Mr. and Mrs. Travis Alford and Ronny McMinn, all of Euless and Mrs. O.J. Cooper of Bogata.

Frances Summers spent Thanksgiving in Gainesville with her daughter, Mr. and Mrs. James Polk and family.

Thanksgiving guests of Mrs. Odella Cheatwood and Mr. and Mrs. Sid Hudson of Mesquite and Stephanie and Chris. Chris is from Texas Tech in Lubbock. Nina Hudson from Bogata was also a guest.

Friday night guests of Mrs. Nina Hudson were Mr. and Mrs. Sid Hudson and family of Mesquite and Luella Swain.

Mrs. Ruby Corbell and Chrystine

Baker visited Nina and Von Pybus in Grand Prairie. They also visited K.C. Yale in Ft. Worth last week.

Thanksgiving visitors of Chris Adams and Randy Randolph were Bobbie and Duane King, Johnny Adams, Diana and Danny Eudy, Belva and Monte Randolph, Kyle and Krutchi King, Nicki, Shelley and Travis, Adam and Aaron Eudy, Kristi and Asa Chambless and Jordan and Kala King and Robert Skinner.

Mr. and Mrs. Jim Bond had as guests for Thanksgiving dinner Mr. and Mrs. Keith House of Bryan, Mr. and Mrs. Virgil Grant of Anchorage, Alaska, Mr. and Mrs. Ross Bond and David of Mt. Pleasant, Scott Abbott of Allen, Mrs. Elsie Hughes, Bro. A.I. Bond, Mr. and Mrs. Dale House and Shane, Dinia, Sabre and Jr. Burson, Sabrena, Misty Jo and Justin Tucker, Mrs. Tim Taylor and Joey Dale of Talco. Visiting in the afternoon were A.G. House of Tulsa, Charles House of Plano and Gordon House.

Thanksgiving holiday guests of Mr. and Mrs. H.W. Smith and Bill Harbison were Mr. and Mrs. Joseph Jan-nise, Liz and Mike of Beaumont, Mr. and Mrs. John Day and Jillina, Mrs. Linda Witter, Todd and Billie Kay from Oklahoma City, Mrs. Billie Griffith and Meg of Irving and Mr. and Mrs. Roy Cox of Millerton, OK.

Dr. and Mrs. Gearald Faris and Cynthia and Sarah Jayne of Longview were holiday guests of their grandmother, Mrs. Fauna Wilkinson.

Mrs. Virginia Pike Coats of Grand Prairie was a Friday guest of Miss Mary Lassiter.

Mrs. Lela Adams is a patient in Franklin Co. Memorial Hospital in Mt. Vernon.

Dr. and Mrs. E.E. Brooks and family spent Thanksgiving with his brother, Dr. and Mrs. Jim Brooks in Ft. Worth.

Annette Swain of Houston was a holiday guest of her grandmother, Mrs. Luella Swain.

Robert White, a student at Baylor Dental School in Dallas, spent the holidays with his parents, Mr. and Mrs. Glen White.

Mrs. Iva Hooker has returned home following a ten day visit in Dallas with her daughter, Mr. and Mrs. Frank Lipscomb and family.

The home of Mrs. Bill Pinkham was over run with family for Thanksgiving. Coming from Ft. Worth were her daughter and son-in-law, Mr. and Mrs. Robert Carter, their four children and their families. IN all, there was Mrs. Pinkham's four generations of children, grandchildren and great-grandchildren and she made the fourth generation.

Mr. and Mrs. Kenneth Pirtle visited Mr. and Mrs. Ken Miller of Commerce this past weekend. They enjoyed open house at the Commerce High School on Thursday night, followed by a concert featuring Reba McEntire in Sulphur Springs on Friday night. After returning home, they enjoyed a fish fry on Saturday night at the home of Mr. and Mrs. Brad Hudson, Brandon and Kami of Deport.

Rebecca Taylor of Tyler spent the Thanksgiving Holiday with her mother, Mrs. Ann Randolph.

Mr. and Mrs. H.W. Smith and family visited Mr. and Mrs. Roy Cox in Millerton, Oklahoma Saturday.

Thanksgiving guests in the home of Mr. and Mrs. Neil Rozell were Mr. and Mrs. David Rozell, Russell Rozell, Mrs. Eleanor McCleure, Mr. and Mrs. James McCleure, Gaylord McCleure, Mrs. Francis Griffin, Mrs. William Rozell, Mrs. Ann Randolph, Julie Randolph, Rebecca Taylor, Suzanne Taylor, Patricia Taylor, Mr. and Mrs. John M. Howison and their son, John Howison.

Mr. and Mrs. George Ford were Bogata visitors during the Thanksgiving Holiday.

Mrs. Robert Blair of Mesquite visited Mr. and Mrs. Albert Forester and Mrs. Edie Forester Thanksgiving.



THE FRESHMEN class at Rivercrest won fourth place in the

Bogata Christmas Parade. The parade was a great success. (Staff

Photo by Diana Eudy)

Mrs. Paul Deberry of Idabel, Ok. was a Thanksgiving guest of Miss Mary Lassiter.

Miss Mary Fortner of Dallas spent the holiday with her parents, Mr. and Mrs. Johnny Gill.

Vera Grogan has returned home following a Thanksgiving visit with Mr. and Mrs. Richard Palmer, Mr.

and Mrs. Jerry O'Brien, and Mr. and Mrs. Jerry Palmer of Houston.

Miss Bobbette French of Dallas spent Thanksgiving with Miss Patricia Taylor and attended the Howison reunion in the home of Mr. and Mrs. Neil Rozell.

Dora Thompson spent Thanksgiving in Dallas with her niece, Mr. and

Mrs. Ray Freeman. Other guests were their daughters, Mr. and Mrs. Steve Unger and children of Ft. Worth and Mr. and Mrs. RANdy Fisher of Irving.

Mrs. Frank Lipscomb of Dallas was a Tuesday guest of Bogata relatives, Truman and Mary Lassister.

## RANDOLPH'S BOOT CORRAL

3577 N.E. LOOP 286 PARIS

OPEN 9a.m.-6p.m. MONDAY-SATURDAY

BOOTS  
NOCONA  
JUSTIN  
COWTOWN  
ACME

CRUMRINE BUCKLES  
EXOTIC BELTS  
WRANGLER JEANS  
LEVIS  
MINNETONKA MOCCASINS

## CHRISTMAS IS...

Christ With Us

"Behold a virgin shall conceive and bear a Son and shall call his name Immanuel." Isaiah 7:14

WORSHIP BECAUSE OF THE CHRIST WITH US



Pastor, Bro. Billy Daniels

JOHNTOWN MISSIONARY BAPTIST CHURCH

## RON COUCH, P.T.

(Licensed Physical Therapist)  
Announces the Opening of

## COUCH PHYSICAL THERAPY CLINIC

for the Practice of Physical Therapy

1901-A North Jefferson  
Mt. Pleasant, TX  
572-3583

Hours By Appointment Physician Referral Required

## ATTENTION HUNTERS AND TRAPPERS

FUR BUYERR Will Be in BOGATA At 271 EXXON Each SUNDAY From 2:15 P.M. Hill 3:00 P.M. Beginning DECEMBER 15th.

We buy green and dry furs of all types. Case skin all furs (like Opossum). We buy Deer hides. Well handled Furs Bring TOP PRICES!

D & W FUR COMPANY INC.  
(Largest in Southern USA)

400 N. Texana  
Hallettsville, Tx. 77964  
Phone 512-798-5057 or 5058

614 Railway St.  
Lometa, Tx. 76853  
Phone 512-752-3256

<b>MILK</b> Cabelts-Gallon \$1.99	<b>BACON</b> Slab Sliced Lb. \$1.19	<b>FRUIT COCKTAIL</b> Del Monte 30oz. Can \$1.09
<b>OLEO</b> Grayson Lb. 43¢	<b>BISCUITS</b> Parade 4/79¢	<b>BREAD</b> Wonder 69¢
<b>KLEENEX</b> 250 Ct. \$1.09	<b>CRACKERS</b> Sunshine Lb. Box 89¢	<b>ONIONS</b> Yellow Lb. 19¢

## JOE FORD GROCERY

SPECIALS GOOD - THURS-FRI-SAT. DEC. 5-6-7

BOGATA 632-5323 LIMITS RESERVED

## Farm Homesteads Protected From Foreclosure By Certain Creditors

By Paul D. Payne

Texas is the only state with homestead laws that protect rural homesteads from foreclosure by general creditors. But the protection is limited by the type of debt owed and to a specific quantity of land.

A rural homestead of no more than 200 acres is protected from foreclosure from debts other than those for the actual purchase of the property, taxes and permanent improvements.

The homestead provisions of Texas law will not protect the home from attachment, execution and forced sale for the payment of debts arising from all or part of the purchase money for the homestead, property taxes, or mechanic's liens for work and material used in constructing improvements on the homestead.

The occupant-owner of the homestead cannot increase the "burden" or amount of the outstanding loan on the homestead. The owner may refinance the homestead property when interest rates become more favorable, but the outstanding balance of the note can be increased only if the extra money covers the cost of improvements, property taxes or refinancing costs.

The protection extends throughout the lives of both spouses and to the minor children and unmarried children remaining with the family of the deceased while they continue to use and occupy the property. Single adults living together, however, cannot claim homestead rights.

These rights also insure that one

spouse cannot sell the homestead without the other's consent. Therefore, both spouses must sign a deed to convey the homestead regardless of whether it is separate or community property.

As a general rule, once a homestead is established it continues until another is acquired. To switch a homestead requires a physical change of residence accompanied by

an intent for the new residence to become the new homestead.

During the farm crisis, homesteads will be protected from general creditors under Texas laws. However, the protection is not available from the creditor loaning the money to purchase the homestead property. For answers to questions about homestead laws, contact a financial institution or an attorney.



## J. R. Is "40"

He Isn't Fading - His Broad Shoulders Just Dropped Down To His Waist Line.

## Roy Selby, M.D.

announces the opening of his practice of Neurological Surgery  
2435 College Drive Suite 8  
Texarkana, Texas 75501  
(214) 794-1202  
Diplomate of the American Board of Neurological Surgery



Polynesian Fruit Punch is a healthful, refreshing way of brightening up a party.

### POLYNESIAN FRUIT PUNCH

- 1 can (46 oz.) Dole Pineapple Juice
- 1 bottle (32 oz.) cranberry juice
- 1 can (6 oz.) frozen lemonade concentrate, thawed
- 1 can (6 oz.) frozen orange juice concentrate, thawed
- 1 bottle (32 oz.) ginger ale
- Lemon slices for garnish

Combine juices, lemonade and orange juice concentrates in a large punch bowl. Blend well. Pour in ginger ale. Add ice cubes. Garnish with lemon slices. Makes about 1 gallon.

For more terrific pineapple juice recipes, write to Dole Pineapple Juice, Dept. PJ5, P.O. Box 7758, San Francisco, CA 94120.



No Room

Burial plots in land-starved Hong Kong are not only expensive but also risk relocation as the living crowd out the dead, National Geographic reports.

## WE COPY OLD PHOTOS!



Bring Your Old Photos To Us, We Can Reproduce Them For You. Quality Work, Careful Handling Of Precious Mementoes.

5x7 \$5.00  
8x10 \$7.50

CALL 652-4205

DEPORT TIMES



**BUY  
SELL  
AND  
TRADE  
WITH...**

# Classified Ads

**ONE PHONE CALL PLACES YOUR AD IN ALL 4 PAPERS**

**BOGATA NEWS 632-5322**  
**DEPORT TIMES 652-4205**

**TALCO TIMES 379-4445**  
**BLOSSOM TIMES 652-4205**

**Jackie Dodd**  
Bull Dozer  
Contractor

Land Clearing  
Dirt Work  
632-4441  
Bogata

**AAA CARPETS**  
& Custom Drapes  
1515 N.E. 20th  
& Loop 286  
Commercial & Residential  
Free Estimates  
Owner-Bill Parks  
Paris, TX 785-4240

**OPPORTUNITIES**

OWN YOUR OWN jean-Sportswear, ladies apparel, childrens, large size, petite, combinatin store, maternity, accessories. Jordache, Chic, Lee, Levi, EZ Street, Izod, Esprit, Tommy, Calvin Klein, Sergio Valente, Evan Picone, Liz Claiborne, Members Only, Gasoline, Healthtex, over 1000 others. \$13,300 to \$24,900 inventory, training, fixtures, grand opening etc. Can open 15 days. Mr. Loughlin (612) 888 6555. 12-4

**GENERAL**

DO YOUR CHRISTMAS shopping! Something For Everyone! Brass items include quilt racks, hall trees, animals, fern stands, etc. Good selection of toys, knives, tools and gift items. Friday, Decembr 6 at 7 p.m., Mt. Vernon Trade Mart, 2 1/2 miles north on Hwy. 37, snack bar open, Herman Hilliard, Auctioneer TXS-106-1596. 12-4

FOR SALE-Stereo, 8 track with stand. Card table with four chairs. Three drawer chest. Call 652-4631. 12-4

## \$5 MINI ADS

**15 WORDS  
3 WEEKS**

**TONY WATKINS**  
Bulldozer Contractor

632-4136  
BOGATA, TEXAS

**BILL PROCTOR**  
Bulldozer Contractor

632-4560  
BOGATA, TEXAS

SAVE 50%!! Flashing arrow signs \$269!! Lighted, non-arrow \$249. Unlighted \$199. (Free letters!) See locally. (800) 423-0163 anytime. (800) 628-2828, extension 504. 12-4

LOST-Texas license plate, 646JMS. Call 652-2956 if found. 12-4

COME IN AND register for \$25.00 worth of T-shirts to be given away December 23. Janie's T-Shirt and Sewing Shop, Bogata. 12-19

PROFESSIONAL Roofing, painting, done with experience. Guaranteed workmanship, total satisfaction promised. Call 632-5903, Bogata. MA tfc

FOR SALE-4 bdr. 2 bath, central air-heat. N. Howison, Bogata. Gerald Stegall 405-326-8180. (MA-12-31)

ALLEN'S FLORIST-Days, 652-2532; nights, 652-4191. Lucy Fowler in Cunningham, 652-5003; Mrs. Fred White in Bogata, 632-5888 or Barbara McDowra in Pattonville, 652-9723. MA tfc

PROFESSIONAL TREE Service-Done with precision and experience. Work guaranteed, no job impossible. Call 632-5903. (MA-tfc)

ROSALIE LODGE-No. 527 stated meeting on fourth Thursday of each month at 7:30 p.m. (MA-tfc)

I DO CARPENTER WORK-plumbing, yard work, garden work, fence building, remove dead trees, house levelling, anything. Call 632-5903 (MA-tfc)

FOR SALE-1976 Chevrolet, 350 engine, air conditioning, power brakes, power steering, automatic, 4-door. 632-5493. MA 12-5

FOR SALE-Oak firewood. Call 632-5369 in Bogata. MA tfc

FOR RENT or sale-Recently remodeled mobile home near Deport. 652-2782 or 652-2785. MA 12-5

FOR RENT-One and two bedroom apartments for rent on Circle Drive in Bogata. Call 982-6495 after 5 p.m. MA tfc

FOR SALE-Wood heater, excellent condition. Call after 5 p.m. 632-5140. MA 12-12

FOR SALE-Building lots in southwest Bogata. Call 332-5374. MA tfc

FOR SALE-'82 Sierra Classic loaded, 40,000 miles, \$6,500. Call 632-5446 or 632-5941. MA 12-12

SPEIR UPHOLSTERY- Located on Main Street, Deport. Commercial, home, automotive and marine upholstery, also new living room suites. Call 652-2942. MA tfc

FOR SALE-' pair men's brown Cowtown bullhide boots, worn twice, size 6 1/2 D, \$40. Call 632-5434 after 5 p.m. MA 12-12

FOR USE OF THE Bogata Community Center for reunions, meetings or parties, contact Carl Wood, 632-5882. MA tfc

FOR RENT-Three bedroom one bath, CH/CA option, TV satellite. \$250.00 per month with reference. Call 379-2781 after 5 p.m. MA 12-19

CRUISE, DINE and DANCE to live band, aboard the Queen Maria Riverboat, Mt. Pleasant. Call 588-2982. MA tfc

FOR SALE-Two Yamaha 125 motorcycles, both \$350. Holiday camper trailer, \$3,300. Call 632-5631. MA 12-12

CALL MRS. BEN WARREN for all your flower needs. Wedding Ring Florist, formerly Robinus, 652-2211. MA tfc

FOR SALE-5 piece French provincial bedroom suite, trundle bed, \$225. Kay Brooks, 632-4137. MA 12-12

DETROIT MEAT Processing Custom killing, processing and wrapping. Also feed lot beef available. 674-6911 or 674-5712. MA tfc

FOR SALE-Hay, square bales, fertilized, mainly Bermuda, some ryegrass and fescue; two grain tanks; one butane tank (1,000 gal.). Call 632-4547. MA 12-12

FOR SALE-Registered grey Brahman bull, 4 1/2 years old, also round rolled hay. Call 632-5344. MA 12-19

CHRIS'S Hickory Smoked Barbeque. Open 11 a.m. until 7 p.m. daily. Highway 271, two miles west of Deport. MA 12-19

HOUSE FOR RENT in Bogata. Call 652-5873. MA 12-19

FOR SALE-In Bogata, 6 room frame house with carpet and storage shed. 632-5661, \$12,500. MA 12-19

FOR SALE-Treadmill exerciser like new, Kirby vacuum with attachments, console stereo. Call 652-2488. MA 12-19

FOR SALE-Herculon sofa hide-a-bed, matching love seat, rocker-recliner, rocker swivel chair, excellent condition. Call 379-7461. MA 12-19

FOR SALE-Sleeper sofa, like new, rocker and occasional chair, two gas heaters, good condition. Call 652-2502. MA 12-19

FOR SALE-Butcher block kitchen table with four chairs. Call 379-7461. MA 12-19

LET ME clean your house for the Holidays, or any day. Any type of cleaning, within arean. Call 214/632-4354 after 3 p.m. MA 12-19

**DIRT HAULING  
WELDING  
INSULATION**

Call 632-5169  
Bogata  
S. E. Dodd

**BOGATA SELF STORAGE**

Monthly Rates  
\$18.00 & Up All Sizes  
Just Off South Main on Fifth  
BOGATA 632-5685

**OPEN YOUR own beautiful** Children's discount shoe store. Nationally known brands, Giggles, USA, LaGear, Pro Keds, Levi, Child Life, Spalding, Young Set, Cherokee and many more. All first quality merchandise that you pay 30 to 40 percent below wholesale and take 150 percent mark up on. \$15,900 to \$19,900 includes beginning inventory, training, fixtures, grand opening promotins and round trip air fare for one. Call today. Prestige Fashions 501/ 329-2362. 12-4

**GARAGE SALES**

RUMMAGE SALE-Furniture, appliances, few household items, toys, odds and ends. Saturday, December 7, 9 to 5, 212 S. Sulphur, Jeff Hancock House. 12-4

PORCH SALE-Saturday, December 7, ONE DAY ONLY, 308 N. Main, Bogata, all new merchandise. 12-4

**W.T. DODD**  
Dozer Contractor  
Dragline  
Land Clearing - Dirt Work

(214) 632-5185  
ROUTE 1  
BOGATA, TEX.

**SAND & GRAVEL  
HAULING**

Loader Work  
Tractor Work

### LEGAL NOTICE

The Highland Cemetery Association of Deport is in need of a grounds superintendent. Duties will be: all upkeep, including mowing of all sections (furnish own equipment, no mowing tractors in grave areas), removal of trash and flowers, trimming of trees and shrubbery, removal of excess dirt on new graves, assist in developing new sections and selling lots. Interested, qualified individuals should send their resume with salary expected for review by the Board of Directors to: Highland Cemetery Association, P.O. Box 317, Deport, TX 75435. Deadline is December 10, 1985.

**SAVE TIME - SAVE MONEY  
USE WANT ADS**

**BULK FOOD • SPICES**

Stone Ground Flour & Cornmeal • Honey • Blueberry Muffin Mix • Pitted Dates • Old Fashioned Horehound Candy • Wheat Germ • Wheat Bran • Donut Mix • Assorted Candies & Nuts • Mennonite Cookbooks • Snow Flake Popcorn • Popcorn Seasoning • New Crop Pinto Beans • Good Selection of Fresh Spices

Assorted Handcrafts • Fabric & Notions  
Organic Whole Wheat Flour Kwik Klean Cleaner

**DUTCH VILLAGE**  
Hwy. 82 E & Airport Road • RENO, TX • 784-5045

**FOR SALE**

Taylorway disc, tandem 12 ft. 4-row John Deere cultivator RG-4 10-row, 3-point hitch spray rig 500 gal. water tank on trailer 6 4-wheel cotton trailer running gears Massey Ferguson No. 12 twine hay baler 7 ft. drag type Sidewinder shredder 7 ft. New Holland hay mower  
Call 214/652-5823

**For Sale**

HOMES: One, Two, Three & Four Bedroom \$11,000 to \$60,000.  
LAND: 10, 17, 25, 38, 53, 132 Acres  
Some with Homes-\$15,000 - \$92,000.

**GARRISON REAL ESTATE**  
632-4346 Bogata 632-5307

### Card of Thanks

The family of Autis (Dude) Vickers, who passed away last Tuesday, wants to thank all the neighbors, friends and relatives for the food and flowers and all the help they did was greatly appreciated.  
Thanks to Rev. Terry Rogers and the pallbearers and Bright-Holland Funeral Home.

## Obituaries

### Randy L. Ferguson Dies At Age 33

U.S. Marine Corps Chief Warrant Officer Randy Lew Ferguson, Twenty-nine Palms, California, died here Monday, November 25. Graveside services with military rites were conducted Friday, November 29 in Meadowbrook Cemetery with the Rev. Jerry Moore officiating. Gene Roden's Sons, Directors of Funerals, had charge of arrangements.  
He was born Sept. 22, 1952, in Temple, a son of Vern Stanley and Betty Ruth Hodges Ferguson. He married Cindy Cooper in August 1976 in Anaheim, California. He was a Baptist.  
Surviving are his wife of Boerne; his mother, Mrs. Roe S. (Betty Hodges) Haney of Boerne; two

brothers, Gary Don Riley of Blossom and Larry Thomas Ferguson of Tucson, AZ; a grandmother, Mrs. T.C. (Glenna) Hodges of Clarksville. He was also the grandson of the late Mr. and Mrs. T.C. (Tode) Hodges of Paris.

### Fred Taylor Dies

Fred Taylor, 91, of Bagwell died Tuesday, November 19 at Red River Haven Nursing Home in Bogata. Funeral services were held at 2:30 p.m. Thursday, November 21 at Bagwell Church of Christ with Benny Cogburn and Aden Petty officiating. Burial was in Blanton Creek Cemetery by Clarksville Funeral Home.  
Mr. Taylor was born April 5, 1894 in Hope, AR, a son of Mr. and Mrs. Monroe Taylor. He was a member of the Church of Christ, the American Legion, and served in the Army during World War I.  
Survivors include his wife, Helen Taylor of Bagwell; two stepsons, Joe Eastman of Sumner and Harry Eastman of Houston; two stepdaughters, Eva Draper of Bogata and Mary Helen Brumalow of Bogata; one sister, Bonnie Staples of Vancouver, Washington; and several nieces and nephews.

### Rankin Bell Dies At Age 75

Rankin Donald Bell, 75, of Garland, died Sunday, December 1 at Garland Memorial Hospital.  
Services were held at 10 a.m. Tuesday, December 3 at Williams Funeral Home Chapel in Garland. Graveside services were at 2 p.m. Tuesday at Highland Cemetery in Deport, the Rev. Richard Blaisdell officiating.  
Mr. Bell was born August 13, 1910 in Deport, a son of J. Frank Bell and Minnie Grant Bell. He was an engineering operator and was a member of the Church of Christ in Garland.  
Surviving are his wife, Ruth Bell of Garland; one daughter, Gwen Womack of Richardson; three brothers, Stanley Bell, Russel Bell and Jack Bell, all of Deport; three grandchildren and three great-grandchildren.

### Eloise L. Sheffield Dies At Age 77

Relatives have received word of the death of Mrs. Eloise Lawler Sheffield (Mrs. Buford Sheffield Sr.) of Brady. Memorial services were held Saturday, November 30 at the Colonial

Funeral Chapel and interment was in Rest Haven Cemetery in Brady.

Mrs. Sheffield was born August 15, 1908 in Deport, a daughter of Norman Swain and Rose Gladish Lawler. She attended Deport Schools and graduated in 1926. She was a member of the First United Methodist Church in Deport for many years. At her death, she was a member of the First Methodist Church in Brady.  
She married Buford R. Sheffield Sr. on November 10, 1928 in Deport. He died June 16, 1978 in Brady.

Survivors include one daughter, Mrs. Lynda Joyce Sheffield Walls of Brady; one son, Buford R. Sheffield Jr. of Brownwood; seven grandchildren; five great-grandchildren; one brother, Dr. Marion R. Lawler of Mercedes; two sisters, Mrs. Kitty Ruth Lawler Coles of Enterprise, LA and Mrs. Frances Elayne Lawler Lee of Arlington; several nieces and nephews and several relatives living in this area.

### Odie Aubrey Dies At Age 78

Odie Aubrey of Paris died Thursday, Nov. 28 at McCuiston Regional Medical Center.  
Services were scheduled for 2 p.m. Friday, Nov. 30 at the Pentecostal

Church in Cunningham with the Rev. Weldon Allen officiating. Burial was in Restland Cemetery at Cunningham by Grant Funeral Home.

Mrs. Aurey was born March 22, 1907 in Lamar County, a son of Will and Susie Petty Aubrey. He married Elsie Rose in Hugo, OK on May 25, 1930.  
Surviving are his wife; four sons, William Ray Aubrey of Milton, Bob Wayne and Kenneth Carroll Aubrey of Grand P—rairie and Ronnie Aubrey of Paris; 23 grandchildren; 10 great-grandchildren. He was preceded in death by a son, Elder Aubrey in 1974.

### Mauda R. Condra Dies At Age 91

Mauda Rebecca Condra, 91, of Bogata, died Wednesday, November 27 at McCuiston Regional Medical Center.  
Services were held Saturday, Nov. 30 at 2 p.m. in the First Assembly of God Church in Clarksville with the Rev. Bill Pirtle officiating. Bogata Funeral Home made burial in Bogata Cemetery.  
Mrs. Condra was born Dec. 5, 1893 in Bowie County, a daughter of Jasper Stephen and Alice Teague Kelso. Her first husband, Pleas Brumblay, preceded her in death. She later mar-

ried James Robert Condra. He died October 16, 1964.

Surviving are a daughter, Vera Laverne Wilson of Ft. Worth; six grandchildren; 15 great-grandchildren and two great-great-grandchildren. She was preceded in death by a son, George Nelson Brumley.  
Bearers were Don Barnard, Paul Ed Pyles, O.L. Stringer, C.L. Bounds, Ed Johnson and Scott Kilmier.

### George A. Russell Dies At Age 79

Former Blossom resident, George A. Russell, born January 21, 1906 in Missouri, died November 15 in Sacramento, California.  
Memorial services were in Sacramento Memorial Lawn on Wednesday, November 20 at 11 a.m. with Chaplain Arnold Vocke officiating. Services were concluded in the Garden Chapel.  
Mr. Russell is survived by his wife, Carmen; four children, all of Sacramento; five sisters, Maggie Arnold of Brentwood, CA, Lucy of Kentucky, Essie Mae of Boulder City, Frances of Nevino, CA and Prudie Bishop of Ft. Worth; several nieces and nephews.



SANTA'S ITEM:  
**Deck the Halls**  
With New Floor Covering  
From Smith Carpets

UPRIGHT EUREKA  
VACUUM CLEANER . . . \$74<sup>95</sup>

INDOOR-OUTDOOR  
CARPET . . . . . Sq. Yd. \$4<sup>95</sup>

100% NYLON PLUSH CARPET OR  
100% NYLON SCULPTURED  
CARPET . . . . . Sq. Yd. \$5<sup>95</sup>

**SMITH CARPETS**  
1289 Clarksville St. 785-6491

American Viewpoints



Knowledge and timber  
shouldn't be much used  
till they are seasoned.  
Oliver Wendell Holmes

have a  
nice  
weekend



THE JUNIORS at Rivercrest won fifth with their entry into the Bogata Christmas Parade. There were a large number of floats and cars and various other vehicles and people in the big parade. (Staff Photo by Diana Eudy)

## Feel The Joy Of Giving Christmas To A Special Child

**Here's The Best Holiday Gift**

The Disney Channel And The Opportunity To Donate One Of The Plush Dolls Of Mickey And Donald To An Underprivileged Child. Sponsored Through The "Assisting Hands" Program.



**LIMITED TIME OFFER!**  
Limited Time Offer  
Nov. 18th - Dec. 20th

**CC I CABLEVISION** 784-0991

### Rivercrest Basketball Schedule

Rivercrest Rebel-Rebelettes  
1985-86  
Basketball Schedule

DATE	TEAM
Nov. 18	Mt. Pleasant 9th Girls
Nov. 19	Prairiland 9th Boys Var Boys-Girls
Nov. 21	Prairiland JV Boys-Girls
Nov. 22	Prairiland 9th Boys Var Boys-Girls
Nov. 23	Prairiland JV Boys-Girls
Nov. 25	Winnboro 9th-JV-Var Girls
Nov. 26	Sulphur Springs 9th-JV-Var Boys
Nov. 29	Hughes Springs Var-JV-Girls
Nov. 29	Winnboro 9th-JV Boys
Dec. 2	Winnboro 9th-JV-Var Girls
Dec. 3	Mt. Pleasant 9th-JV-Var Boys
Dec. 5-6-7	Rivercrest Invitational Tourney Var
Dec. 10	Roxton Var Boys-Girls
Dec. 12	Winnboro 9th Boys
Dec. 12-13-14	Celeste Invitational Tourney Var Boys-Girls
Dec. 16	Cooper 9th Girls
*Dec. 17	Karnack Var-JV Girls
Dec. 19	Paris 9th-JV-Var Boys
*Dec. 20	Harmony Var-JV Girls
Dec. 26-27-28	Leonard Holiday Tourney Var Boys-Girls
*Jan. 2	Redwater JV Boys Var Boys-Girls
*Jan. 4	Ore City JV Girls Var Boys-Girls
*Jan. 7	New Diana JV Boys Var Boys-Girls
Jan. 9	Mt. Vernon 9th Boys
*Jan. 10	Maud JV Girls Var Boys-Girls
Jan. 11	N. Lamar 9th-JV Boys
*Jan. 14	Harleton JV Boys Var Boys-Girls
*Jan. 17	Karnack JV Girls Var Boys-Girls
Jan. 18	Paris 9th-JV Boys
*Jan. 21	Harmony JV Boys Var Boys-Girls
*Jan. 24	Redwater JV Girls Var Boys-Girls
Jan. 25	N. Lamar 9th-JV Boys
*Jan. 28	Ore City JV Boys Var Boys-Girls
*Jan. 31	New Diana JV Girls Var Boys-Girls
Feb. 1	Paris 9th-JV Boys
*Feb. 4	Maud JV Boys Var Boys-Girls
*Feb. 7	Paris 9th-JV Boys
*Feb. 11	Maud JV Boys Var Boys-Girls
*Feb. 14	Harleton JV Girls Var Boys-Girls
Feb. 13-14-15	Karnack Var-JV Boys
Feb. 17-18	Harmony Var-JV Boys
Feb. 20-21-22	Girls Bi-District
Feb. 24-25	Girls Area
Feb. 27-Mar. 1	Boys Bi-District Girls Regional Tourney
March 7-8	Boys Area
	Boys Regional Tourney: Girls State Tourney
	Boys State Tourney

\*Denotes District Games

### Rabies Precautions Should Be Taken

There has been an increase in the number of rabies cases reported in East Texas counties, including Red River and Lamar, during the fall of 1985 in both wild and domestic animals. Skunks and bats are the primary reservoirs in the wildlife population. In order to decrease the possibility of exposure to the human population it is essential that all dogs and cats be vaccinated against rabies as these vaccinated animals will serve as a buffer zone between humans and the threat of rabies in the wildlife reservoir.

The State of Texas requires that all dogs and cats 4 months of age and older be vaccinated and they must also receive a revaccination annually thereafter. This is the best protection that a pet owner can give to his pet and to his family. A recent state law also prohibits the sale and administering of rabies vaccine by anyone except a licensed veterinarian. In the event of human exposure to a rabid animal we fortunately have a highly effective and safe human rabies vaccine that is maintained by the Texas Department of Health. This new vaccine replaced the previously used "Pasteur treatment" which required a series of shots in the stomach. When an individual is exposed today and treatment is recommended by the physician, a person should not become alarmed with many of the older stories about rabies treatment and its associated pain. This new product is greatly improved.

There are many things that the individual citizen can do to prevent exposure to rabies and the necessity for having to undergo post-exposure treatment. Some of these are: report all animal bite cases to the Local Health Authority immediately; confine all dogs or cats involved in bite cases so they may be observed for a 10 day quarantine period; wild animals should be immediately submitted for testing to determine if in fact the animal actually had rabies-they should never be quarantined; if the animal is to be destroyed do not damage the brain to interfere with laboratory diagnosis and a fresh refrigerated specimen is necessary. In the event of potential exposure to rabies, thorough washing of the bite area with soap and water is a highly effective measure of minimizing exposure. All of these precautions may be helpful in preventing unnecessary anti-rabies treatment.

Your local physician, veterinarian, health department or animal control officer should be contacted for any additional guidance concerning both human and animal exposure to rabies.

# HUDDLESTON GROCERY

632-5624  
BOGATA  
HOURS 7 A.M. - 7 P.M.

SPECIALS GOOD EVERY DAY

THURS-FRI-SAT- & MON-TUE-WED. DEC. 5 - 11

QUANTITIES LIMITED

 <b>MILK</b> Bordens-Gallon \$2 <sup>29</sup>	 <b>WEINERS</b> Deckers 12oz. Pkg. 99¢	 <b>GROUND MEAT</b> Fresh Lb. \$1 <sup>19</sup>	 <b>FRYERS</b> Lb. 59¢	 <b>FLOUR</b> Gladiola 5 Lb. Bag 89¢
 <b>BOLOGNA</b> Deckers Lb. \$1 <sup>19</sup>	 <b>EGGS</b> Grade A Large 89¢	 <b>WAFERS</b> Sunbeam Nilla 10oz. Bag 2/\$1	 <b>BANANAS</b> Lb. 29¢	 <b>SALMON</b> Honey Boy Pink 15oz. Can \$1 <sup>59</sup>
 <b>CORNBREAD MIX</b> Gladiola 5/\$1	 <b>PEAS</b> Bushs Purple Hull 15oz. Can 3/\$1	 <b>TEA BAGS</b> Lipton Family Size 24 \$1 <sup>79</sup>	 <b>CORN</b> Parade Cream Style 17oz. Can 3/\$1	 <b>APPLES</b> Red Juicy Lb. 49¢
 <b>TOWELS</b> Bounty Large Roll 89¢	 <b>PINTO BEANS</b> 24oz. Bag 2/\$1	 <b>VIENNAS</b> Libbys 5oz. Can 2/89¢	 <b>DORITOS</b> Chips 7oz. Bag \$1 <sup>19</sup>	 <b>HONEY BUNS</b> Hostess FRIED PIES Mrs. Bairds 3/\$1
 <b>COKE, DIET COKE, SPRITE, TAB, RC, 7UP</b> 2 Liter 99¢	 <b>MACARONI &amp; CHEESE</b> Parade Dinner 4/\$1	 <b>BUNS</b> Mrs. Bairds Hamburger 6 Pk. 59¢	 <b>BISCUITS</b> Parade & American Maid 2/39¢	 <b>BREAD</b> Mrs. Bairds Wonder Ideal 69¢
 <b>COKE, DIET COKE, SPRITE, TAB</b> 6 Pack Cans \$1 <sup>39</sup>				

ARE WE ANYWHERE NEAR DES MOINES?



Cross-Country

The first persons to drive from San Francisco to New York City in an automobile were H. Nelson Jackson and Sewall K. Crocker, says National Geographic World. The trip, which they made in 1903, took 63 days.



The American Red Cross was originated in 1881 by Clara Barton, who became the first president.