

Baze Bookbinding XX
514 W. 7th Street
Amarillo, Texas 79104

Silverton: Home of Scenic Lake Mackenzie

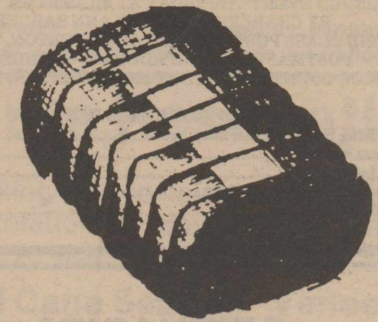

Briscoe County News

THURSDAY, SEPTEMBER 4, 1986

VOLUME 78 NUMBER 36

State May Be Trying To Pass Budget Problems To Local School Districts

by Mary Ann Sarchet

The special session of the Legislature ends today, and this won't give you much time to act on the problem I am about to present if the Legislators surprise everyone and resolve the budget deficit before the session ends. Most likely, a second special session will be called.

You will recall the "no new taxes" Legislature that met during the last regular session. Apparently, our Legislators are

trying to do this again. Before, they raised "fees" and not taxes, but if you want to feel the brunt of the "no new taxes" just check to see how much higher your automobile registration was this year than it had been before the "no new taxes."

The Legislature seems about to do this to us again, this time by robbing—and I do consider it an act of theft—the permanent school fund, the interest on which provides a lot of the monies local school districts use to finance their operations. (This is like killing the golden hen.)

A House proposal is to take as much as \$700 million out of the Permanent School Fund and almost \$300 million out of the Permanent University Fund.

These funds were created by law by our forefathers in an effort to guarantee that money would be available to finance Texas' schools.

Reductions considered in the amounts schools would receive include a local fund assignment increase from 33.3 percent to 34.4 percent, which would cost school districts \$65 million. A pro-rata reduction would cut the school districts' state aid per student by approximately \$70 per student average daily attendance.

The Legislature created the career ladder allotment and forced schools to go to this

See STATE MAY—
Continued on Page Two

August Rainfall Totals 7.35 In.

Silverton has exceeded its annual rainfall of 20.50 inches with the 7.35 inches received during August. A light rain was continuing Tuesday morning at this writing, adding to the 20.51 inches already recorded by Fred Strange.

This made August the wettest month so far in 1986, closely followed by June when 6.57 was recorded.

Some warm weather and sunshine is needed now, to go ahead and make a cotton crop and to

prevent the ruin of tomato and other vegetable crops in the field. Corn harvest is expected to begin as soon as fields are dry.

1986 RAINFALL TO DATE

January	0.00
February	1.08
March	.30
April	1.60
May	3.45
June	6.57
July	.16
August	7.35
Total	20.51

All Around
The Town

BY MARY ANN SARCHET



I know it looks like when I get on a particular subject, I just never let it go; however, last week's column wasn't meant to begin a series. (The clean-up, fix-up was.) The matter of the kids with guns running around town shooting songbirds is akin to anyone shooting gamebirds (like pheasants and quail) out of season, and is against the laws of the state.

We have learned more about this situation since the first column was written, which definitely demands that more be told.

Seems that the kids with the guns aren't just running loose in our neighborhood, but are attacking the birds all over town—even to the extent of climbing over backyard fences to shoot them in enclosed yards. They are shooting at them on highline wires, as well, and this could cause a power outage.

On Thursday afternoon of last week, the kid-gun problem escalated into a matter not just for the game wardens, but also for the local sheriff's department. Three pickups, parked at homes next-door to one another, got their windshields shot up. One pickup had twelve holes in its windshield, and the numbers in the others varied with the least number being three. This is vandalism, folks, even if the B-Bs, pellets or whatever might have hit the windshields after being fired at birds.

I repeat: if you have a kid or kids out running around town with a gun, you'd better have a talk with them about what they are shooting at if you don't want to have them in trouble with the law about it. The kids need to be

See ALL AROUND THE TOWN
Continued on Page Two

Owls Open Football Season At Home

Silverton's Owls will open their football season on Payne Field Friday night at 7:30 o'clock with Higgins.

Higgins has only eight players this year, while Silverton has 16, according to Coach Jack Shely, who adds that the eight players that Higgins has are good players.

"We haven't done very well in our scrimmages," the coach said. "We have problems which we have been hoping to overcome, but we haven't done this as well as we had hoped to."

Bob Loy, the boys basketball coach, and Gary Childs, the girls basketball coach who comes here from Tolar, Texas and is a recent graduate of Tarleton State University, are assisting Coach Shely with the football program.

The Booster Club will be selling homemade charcoal grilled hamburgers at the football field beginning at 6:00 p.m.

Hunters' Safety School Offered

A hunters' safety school will be offered in Silverton, with registration to be conducted at the Silverton Scout Hut Monday, September 8, between 7:00 and 8:30 p.m.

A \$1.00 fee is required for registration.

Classes are scheduled to be held September 15-19, with Virgil and Gladys Kidwell as instructors. For further information, you may call 823-2184.

Friday.

It will be Parents' Night, and the players and their parents will be introduced prior to the 7:30 p.m. kickoff.

Booster Club To Have Hamburger Supper Friday

The Booster Club will be sponsoring a hamburger supper at the football field on Friday, September 5, beginning at 6:00 p.m., before the game with Higgins which begins at 7:30 p.m. The charcoal grilled hamburgers will be \$2.00 each, which will include chips. Drinks will be extra.

Friday night has been designated as Parents' Night, and parents will be introduced with the players shortly before the kickoff.

A booth will be set up at the game for enlistment of new members.

Silverton Booster Club will meet every Monday at 7:30 p.m. in the Junior High Building. Films will be shown and business discussed.

Blood Drive Is September 16

There will be a blood drive from 10:00 a.m. to 1:00 p.m. September 16 at the Silverton City Hall.

Coffee Memorial Blood Center's bloodmobile will be here to take the blood donations.



Leading cheers for the Owls this fall are [kneeling, left to right] Julie Towe, DeLyn Patton, Traci Tomlin; [standing] Kim Burson, Shannon Bingham and Stacie Chappell.

—Briscoe County News Photo

4-H Organizational Meeting Is Tuesday

There will be a 4-H organizational meeting at 7:00 p.m. Tuesday, September 9, at the Briscoe County Show Barn in Silverton. Parents are needed and welcome to attend.

The meeting is open to all boys and girls between nine and nineteen years of age regardless of socioeconomic level, race, color, national origin, religion or handicap.

Freeman Tate was to enter High Plains Baptist Hospital in Amarillo Monday for tests. He has recently spent eight days at Swisher Memorial Hospital in Tulia.

Mrs. Ollie McMinn was taken to High Plains Baptist Hospital in Amarillo Sunday morning by the Silverton Volunteer Ambulance Service.

Mrs. Gayle Robertson returned home Tuesday after having been in the hospital for several days.

BRISCOE COUNTY NEWS
 [SECD-065280]
 PUBLISHED EVERY THURSDAY AT SILVERTON, TEXAS 79257
 BY CHARLES AND MARY ANN SARCHET
 SECOND CLASS POSTAGE PAID AT SILVERTON, TEXAS 79257
 POSTMASTER: SEND ADDRESS CHANGES TO
 BRISCOE COUNTY NEWS, BOX 130, SILVERTON, TEXAS 79257

SUBSCRIPTION RATES PER YEAR
 Briscoe and Adjoining Counties (tax inc.).....\$ 9.99
 Elsewhere in Texas (tax inc.).....\$11.04
 Outside of Texas (not taxable).....\$10.50
 CHARLES R. SARCHET.....PUBLISHER
 MARY ANN SARCHET.....EDITOR

OBITUARIES

BETH REID

Funeral services for Elizabeth Cotter Reid, 80, of Tulia were conducted at 2:00 p.m. Saturday at the First Presbyterian Church with the Rev. Darrel Cory, pastor, officiating. He was assisted by Earl Cantwell, minister of the Rock Creek Church of Christ.

Graveside rites and burial were conducted in the Silverton Cemetery, with arrangements directed by Wallace Funeral Home of Tulia.

Mrs. Reid died at 11:20 a.m. Thursday at Swisher Memorial Hospital in Tulia following a lengthy illness.

She was born in Sulphur Springs on June 22, 1906, and was the daughter of James Cotter, a pioneer of Alpine who went to the Davis Mountains of Texas in the 1880's. She married Warner Hamilton (Nig) Reid January 5, 1925 in Alpine.

Both Mr. and Mrs. Reid taught school in Floyd and Briscoe counties, having moved to Swisher County in 1930 from Alpine. Mr. Reid died in 1985.

She was a member and elder of

the First Presbyterian Church in Tulia.

Survivors include two daughters, Mrs. Billy (Mike) Settle of Silverton and Mrs. Sue Osburn of Tulia; five sisters, Josephine Scott of Farmington, New Mexico, Blanche Jennings and Dorothy Reid, both of Fort Davis, Clarice Scott of San Antonio and Florrie Anderson of Kerrville; and four grandchildren, Warner Bill and Suzann Settle of Silverton, Shonda Lynn and Linda Kay Osburn of Tulia.

Pallbearers were Paul Hays, Vinson Smith, Roy Thompson, Roy Dee Thompson, John Brown and George James.

The family suggested memorials be made to the Silverton Cemetery or to the Senior Scholarship Fund of the First Presbyterian Church in Tulia.

Cal Brannon was a patient last week at Swisher Memorial Hospital in Tulia. He moved to Amarillo over the weekend, where he will be working and attending Texas State Technical Institute.

All Around The Town

BY MARY ANN SARCHET



Continued From Page One

told what they should and shouldn't be shooting at, and also that it's not a very good idea to be firing at anything within the city limits.

A hunter safety class is scheduled to begin with registration next Monday night at the Scout Hut. Those who are under 12 years of age can only attend this class if accompanied by a parent, but it might be very well for the parents to take time to participate in this with their under-age kids. It might save them some problems down the road.

Incidentally, I do appreciate the parents who HAVE spoken to their kids about their guns. They care enough about their family to make sure what is going on.

The following article was contributed for the paper by someone who prefers that his name be withheld.

People who have not had the privilege of experiencing the cultural advantages of living in a small town often ask the question: "What do you do for excitement around here?" In the event of such a question, you might pass along the following.

It seems that a certain white heifer (whose pedigree reaches all the way to France and was won in the calf scramble at the Houston Livestock Show) decided it was time to start a family and began to glance about with a romantic eye. As luck would have it, that eye fell upon a "handsome stranger" to wit: one Longhorn bull owned by Thomas Lee Perkins, weight approximately 1500 pounds (the bull, not Thomas Lee).

Being the coy, shy young thing, their heifer demurely broke out of her pen and with all the subtlty of a locomotive broke into his pasture. Thomas Lee, upon observing this, and fearing his bull was about to be attacked, called for help.

Since the local ag teacher and the young man who owns the

love-crazed creature were both out of town, to whom could he turn but LaVern Kingery at the lumber yard. She, in turn, enlisted the aid of the top cowboy talents of Tobe Riddell, Donnie Perkins, Floyd Perkins, Santos Segura, and her brother, S. N. Davis of Dallas, and her husband.

The expense of engaging such notable talent will no doubt be considerable. The owner will probably be billed by each of these worthies shortly. (terms 2%, 10 days, net 30.) Thomas Lee, however, kept shouting, "I get the pick of the litter."

But alas, it is feared that the swift and effective manner with which the above-named cowboys went about their task prevented this "match made in heaven." It may also have denied Silverton a claim to fame, possibly starting a new and exotic breed. Would it have been the "Char-horn" or "Long-let"? The possibilities are unlimited.

Oh, if you could have only seen all the huffing, puffing, stumbling, falling and yelling. It would have been enough excitement to last a lifetime, and it all happened right in our own little Silverton!

STATE MAY BE TRYING TO PASS BUDGET PROBLEMS TO LOCAL SCHOOL DISTRICT

Continued From Page One

program whereby deserving teachers earn raises, and now wants to pull the rug out from under the schools by reducing the allotment from \$140 per ADA to \$95 per ADA.

The state is considering "saving" \$29 million by reducing the amount it provides for vocational education. Full-day kindergarten returning to half-day supposedly would save the state \$40 million, but imposes a hardship on parents who live in the country.

Any of these cuts would simply pass the budget shortfall to school districts and would result in local property tax increases.

The Legislature has already cut the size of the school district's tax base by providing so many exemptions, and those

of us who are still helping carry the load are becoming a smaller and smaller group that is being backed into a corner that we probably won't be able to get out of.

In sort, cuts in public education will not prevent a tax increase, but will shift the tax increase from the state to the local level; for some reason, this appeals to some of our Legislators who believe this to be "no new taxes."

Granted, it isn't the fault of the Legislature and it isn't because of wild spending that Texas' budget problems have escalated. The state has continued its spending at the level already established, but the state's income has greatly diminished due to the depressed agricultural and oil economies. All this is unfortunate, but we know something has to be done. The most acceptable thing to the largest number of people seems to be an increase in the state sales tax. This really is one of the fairest taxes of all. But, whatever the solution, right now is the time to contact State Representative Foster Whaley and State Senator Bill Sarpalius to encourage both of them to remember that it is against state law to rob the permanent school fund and ask them not to change the law to help them take an easy way out of the budget crunch.

Perry Brunson, who is president of the Silverton School Board, tells me that he has been in Austin twice in regard to this matter, and he just can't see any other way out of this situation except for the state to raise taxes.

I can't see any other way, either; I don't like increased taxes, but our Legislators are just going to have to have the grit to do what has to be done and call it what it is: a tax hike. This is distasteful, especially to those who are running for re-election this year, but they are going to have to do it and not try to disguise it.

Hans Christian Andersen wrote 168 fairy tales during his lifetime.

Shear Delight Beauty Salon



★ Scandinavian Tanning System
 ★ Hair Care for Every Member of the Family
 823-2468 Silverton, Texas

NEIL A. BRYSON, DDS, Inc.

General Dentistry

Briscoe County Medical Clinic
 Silverton, Texas

Hours by Appointment
 806-995-4191

The Congregation of the CHURCH OF CHRIST Meeting at Rock Creek

EXTENDS A GRACIOUS WELCOME TO ALL TO ATTEND ANY AND ALL OF OUR SERVICES.

Sunday
 Morning Worship10:30 a.m.
 Evening Worship6:00 p.m.
 Wednesday
 Evening7:00 p.m.



Be Sure

Trust the knowledge and skill of our competent pharmacists when in doubt about your prescription.

We Can Mail Your Prescriptions To You

995-3525
 CITY DRUG STORE
 Hwy. 86 & Maxwell
 Tulia, Texas

WHEN THE SUN DON'T SHINE, YOU STILL CAN!
TAN YEAR 'ROUND

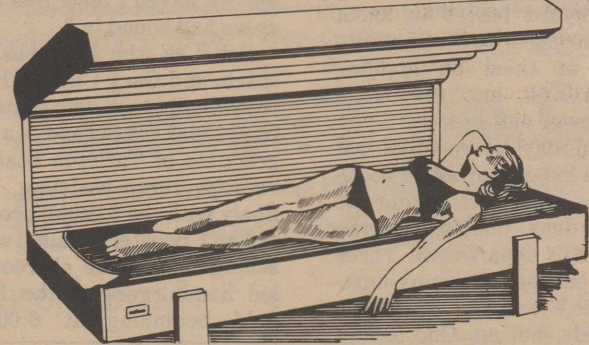

Scandinavian TANNING SYSTEM

BACK TO SCHOOL SPECIAL

GOOD DURING SEPTEMBER 1986 ONLY

20 30-Minute Sessions... \$50.00
 30 30-Minute Sessions... \$70.00

823-2468

708 6th Street Silverton

Shear Delight Beauty Salon

Looking Back

through the files of the Briscoe County News

August 26, 1976—Dean Allard buried Wednesday . . . Mrs. Dorothy Vaughn buried in Arkansas . . . Funeral services conducted for Mrs. Belton Etta (Belle) West, 87, of DeLeon . . . Announcement has been made of the promotion of Donald Dee Weast from Assistant Cashier to Assistant Vice President of the Plains National Bank in Lubbock . . . Mr. and Mrs. Roger L. Harrison are parents of a son . . . Officers elected by the Silverton Booster Club are Joe Brannon, president; Jack Robertson, vice president, and Mary Jane Patton, secretary-treasurer. Peggy Fleming and Shirley Durham were placed in charge of the concession stand for the home football games . . . Mr. and Mrs. Tommy Don Burson are making their home on a ranch near Silverton following their marriage in the home of her parents August 12 . . . Dianna Lynn Purcell to wed David Wayne Johnston . . .

September 1, 1966—Sp. 5 Mike Norris earns ninth Oak Leaf Cluster . . . Elected as officers of the FFA chapter Monday were Tommy Edwards, president; Buddy Comer, vice-president; Leland Wood, secretary; Doug Turner, treasurer; Max Stevenson, sentinel; Van May, reporter . . . Airman Third Class Joseph C. Kellum has been graduated with honors at Chanute AFB, Illinois from the training course for U. S. Air Force jet aircraft mechanics . . . Owl coaches this school year for football are Bobby Herbert Stephens, Jerry Nutt and Tommie Thornburg . . . Businesses to observe birthday of Mayor Jimmie House on Labor Day . . . Mr. and Mrs. W. J. Carter of Quitaque to observe 65th wedding anniversary . . . Mr. and Mrs. Freddie Edwards are parents of a daughter . . . Mr. and Mrs. Floyd Perkins are parents of a son . . . Mr. and Mrs. Leland Campsey are parents of a daughter . . .

August 30, 1956—Newly-completed modern gymnasium ready for use . . . Attractive new elementary school building will be opened for the first time this school year . . . John Burson, 92, a retired rancher, banker and farmer, died at 5:30 p.m. Monday at Underwood Clinic in Amarillo. He had been in failing health for several years . . . Funeral services conducted for Dana Gail Croft, baby daughter of Mr. and Mrs. Lewis Croft . . . Silverton gets first bale of cotton Tuesday . . . Wilson Grain Company receives first load of grain . . . Dr. C. H. Black opens Briscoe County Hospital . . . Miss Anna Lee Anderson returns home from three-week vacation trip . . . Randy Logan honored on seventh birthday . . .

August 13, 1936—Mrs. G. W. Sweat and Mrs. A. G. Stevenson were pleasing and cordial hostesses when they entertained the Floral Club at the home of Mrs. Stevenson last Friday afternoon . . . G. W. Blair has been transferred by the State Highway Department to the Lubbock Division and will report there for

work August 16. His place here will be taken by Ralph Chitman, who is being transferred from Tulia . . . Classified ad: Vote for W. W. Martin for County Judge and reward twenty months of faithful, efficient and economical service by giving him a second term . . . Red Diviney further improved his modern laundry this week by the addition of a steam boiler . . . Among those receiving degrees at West Texas State Teachers College are Anna Lee Anderson, Mrs. A. L. Redin, Sadie Summers, Orville P. Cowart and Marcus Joel Graham . . . Two departments have been added to the high school schedule this year. They are Home

Economics and Vocational Agriculture, with Alla Mae Tipps and Lem Weaver having been employed as instructors. Mr. Weaver comes here well recommended from Childress County and already is at work with the boys, making dairy herd tests, terracing projects and so forth. Miss Tipps, Quitaque, comes from Valley View in Montague County . . . W. W. Wilson is the coach handling the football team this year, and has the enthusiastic backing of all the boys and fans . . . H. S. Sanders was very agreeably surprised at a Stag Party given by his wife in honor of his forty-seventh birthday on Wednesday evening . . . Loney

Stout, who is in the Plainview Sanitarium, is reported to be in a critical condition. He was given a blood transfusion Wednesday evening in the hopes of improving his condition. Kemp Thompson furnished the blood for the transfusion . . .

FISHING-HUNTING LICENSE CHANGES NOTED

The new Texas Hunting Guide has been published and Game Warden Julius Stevens points out some changes that will affect many hunters and fishermen in this area.

Beginning September 1, there are no hunting and fishing exemptions. Persons under 17

and over 65 will have to pay \$6.00 for a hunting and fishing license.

For the same group there is no charge for a fishing license, but all under 17 and over 65 must sign up for one.

The combination hunting and fishing license for all other ages is \$15.00.

As usual, all licenses expire August 31.

Some fishing rule changes include a limit of 25 crappie per day and five a day on bass. Bass must be 12" long to be keepers.

The Hunting Guide and Texas Freshwater Fishing Guide pamphlets are available in the office of County and District Clerk Bess McWilliams.

GERMANY IN COLLAPSE

BRISCOE COUNTY NEWS

THURSDAY, MAY 3, 1945 (with articles selected from other issues) Published Weekly at Silverton, Texas VOLUME XXXVIII NUMBER 18

PRICE \$5.00 PER ANNUM

Complete Surrender of Nazis Is Expected Momentarily

HITLER HAS COMMITTED SUICIDE! MUSSOLINI HAS BEEN EXECUTED! ALL GERMAN ARMIES IN ITALY HAVE SURRENDERED UNCONDITIONALLY! BERLIN HAS FALLEN TO THE RED ARMY TROOPS

These are a few of the world shaking events of the past few days that are leading to the unconditional surrender of all German armies to the plunging American and Allied troops.

Rumors have spread premature surrender news already several times, but when that news is official it will be announced by radio to the American people by President Truman.

Hitler has committed suicide, it is reported. He was shot by a Soviet soldier in Berlin. He was shot in the back of the head. He was shot in the back of the head. He was shot in the back of the head.

Mussolini has been executed. He was shot by a French soldier in Italy. He was shot in the back of the neck. He was shot in the back of the neck. He was shot in the back of the neck.

All German armies in Italy have surrendered unconditionally. They have surrendered to the American and Allied troops. They have surrendered to the American and Allied troops. They have surrendered to the American and Allied troops.

Berlin has fallen to the Red Army troops. The city has been captured by the Soviet forces. The city has been captured by the Soviet forces. The city has been captured by the Soviet forces.



PFC DEE McWILLIAMS was wounded in Germany on April 18. One week later he was in a hospital in England. He is now in the South Pacific and has a 45 day furlough.

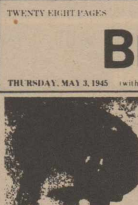

RAYMOND HUNT is here visiting his wife and children and his parents. He was in the South Pacific and has a 45 day furlough.



LEROY CUPPELL has again gone overseas to the Pacific Theatre of War.



J. J. ROWELL is in the South Pacific on a mail boat.

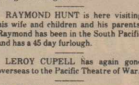

JOHNNY SIMS who has been a prisoner of the Germans has been liberated. His camp Stalag 7A was liberated last week end.



FREEMAN TATE, husband of Jack in Bonar arrived in Amarillo Thursday at noon. He has been in the Navy for 18 months and this is his first leave. Mrs. Tate went to Amarillo to meet him.

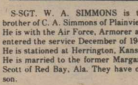

JIM NEATHERLIN writes Dear Boy: Here I am right back where I started from. Only this time I'm not going through boot training.

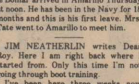

Mrs. J. A. Bain came last Tuesday from Hamilton to visit with Mr. and Mrs. John Bain. Mr. and Mrs. Bain left for their home in Hamilton on Tuesday night.

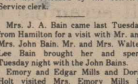

S. SGT. GORDON FORD is in the Air Force as a radio technician. He is a member of Mrs. C. A. Simmons of Plainview and Mrs. R. N. McDaniel. He is married to the former Margaret Scott of Red Bay, Ala. They have one son.



S. SGT. W. A. SIMMONS is the brother of C. A. Simmons of Plainview. He is with the Air Force. He entered the service December of 1941. He is stationed at Herington, Kansas. He is married to the former Margaret Scott of Red Bay, Ala. They have one son.

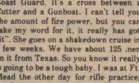

JOHN Y. BRADFORD, Jr. S. Sgt. is the son of Mr. and Mrs. J. T. Bradford. He entered service in September of 1944. He is stationed at San Diego, Calif. He is attending West Coast School. He is 18 years old and a graduate of Central High School of Silverton.

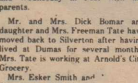

Rev. J. H. Hardesty of Abilene was here over the week end.

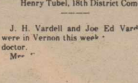

Mrs. Arthur Arnold, Mr. and Mrs. Doug Arnold visited Rev. Porter Arnold who underwent an operation last Wednesday. Rev. Arnold's home is in Silverton.

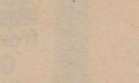

J. H. Varden and Joe Ed Varden were in Vernon this week.



Mrs. Dick Bonar and daughter and Mrs. Freeman Tate have moved back to Silverton after having lived in Dallas for several months. Mrs. Tate is working at Arnold's City Grocery.

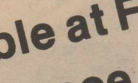

Mrs. Ester Smith and Mr. and Mrs. J. H. Varden were in Vernon this week.

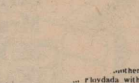

Mrs. Roy Ladd of Floydada was in Silverton Saturday afternoon.

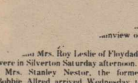

Mrs. Stanley Newton, the former Lillian Newton, arrived in Silverton Tuesday night.

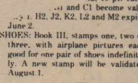

Mrs. Charles Jones returned last Wednesday from Lubbock. She will have charge of the Bank Exchange. Mrs. Jones has received but will help Mrs. Jones through the month of May.

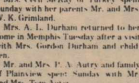

Mrs. Johnnie Burson, Mr. and Mrs. Iron McJannet and Mr. and Mrs. Fred McJannet are in Silverton today for a visit with Mr. and Mrs. Johnnie Burson.

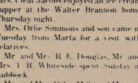

Mrs. Fred McJannet, Mr. and Mrs. Fred McJannet and Mr. and Mrs. Fred McJannet are in Silverton today for a visit with Mr. and Mrs. Johnnie Burson.

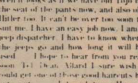

Mrs. P. H. Dugan, Mr. and Mrs. P. H. Dugan, Mr. and Mrs. P. H. Dugan are in Silverton today for a visit with Mr. and Mrs. Johnnie Burson.

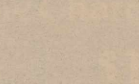

Mrs. Phyllis Brown, the host of the First Night party at the home of Mrs. Brown in Silverton, was in Silverton Tuesday night.

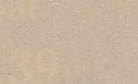

Mrs. M. L. Brown, the host of the First Night party at the home of Mrs. Brown in Silverton, was in Silverton Tuesday night.

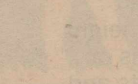

Mrs. M. L. Brown, the host of the First Night party at the home of Mrs. Brown in Silverton, was in Silverton Tuesday night.



S. SGT. W. A. SIMMONS is the brother of C. A. Simmons of Plainview. He is with the Air Force. He entered the service December of 1941. He is stationed at Herington, Kansas. He is married to the former Margaret Scott of Red Bay, Ala. They have one son.



Mrs. Dick Bonar and daughter and Mrs. Freeman Tate have moved back to Silverton after having lived in Dallas for several months. Mrs. Tate is working at Arnold's City Grocery.

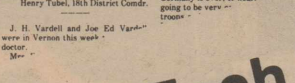

Mrs. Ester Smith and Mr. and Mrs. J. H. Varden were in Vernon this week.

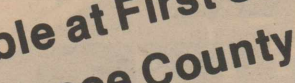

Mrs. Roy Ladd of Floydada was in Silverton Saturday afternoon.

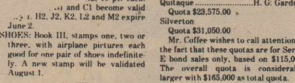

Mrs. Stanley Newton, the former Lillian Newton, arrived in Silverton Tuesday night.

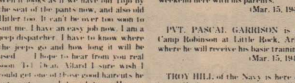

Mrs. Charles Jones returned last Wednesday from Lubbock. She will have charge of the Bank Exchange. Mrs. Jones has received but will help Mrs. Jones through the month of May.

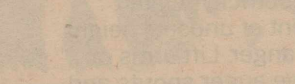

Mrs. Johnnie Burson, Mr. and Mrs. Iron McJannet and Mr. and Mrs. Fred McJannet are in Silverton today for a visit with Mr. and Mrs. Johnnie Burson.



Mrs. Fred McJannet, Mr. and Mrs. Fred McJannet and Mr. and Mrs. Fred McJannet are in Silverton today for a visit with Mr. and Mrs. Johnnie Burson.

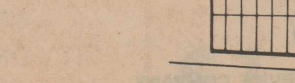

Mrs. P. H. Dugan, Mr. and Mrs. P. H. Dugan, Mr. and Mrs. P. H. Dugan are in Silverton today for a visit with Mr. and Mrs. Johnnie Burson.

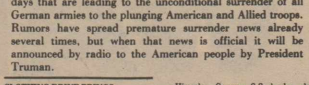

Mrs. Dick Bonar and daughter and Mrs. Freeman Tate have moved back to Silverton after having lived in Dallas for several months. Mrs. Tate is working at Arnold's City Grocery.

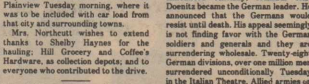

Mrs. Ester Smith and Mr. and Mrs. J. H. Varden were in Vernon this week.

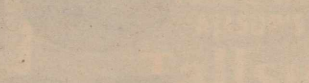

Mrs. Roy Ladd of Floydada was in Silverton Saturday afternoon.

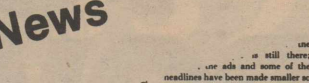

Mrs. Stanley Newton, the former Lillian Newton, arrived in Silverton Tuesday night.

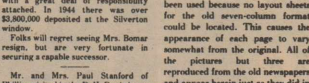

Mrs. Charles Jones returned last Wednesday from Lubbock. She will have charge of the Bank Exchange. Mrs. Jones has received but will help Mrs. Jones through the month of May.



Mrs. Johnnie Burson, Mr. and Mrs. Iron McJannet and Mr. and Mrs. Fred McJannet are in Silverton today for a visit with Mr. and Mrs. Johnnie Burson.

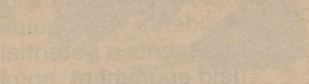

Mrs. Fred McJannet, Mr. and Mrs. Fred McJannet and Mr. and Mrs. Fred McJannet are in Silverton today for a visit with Mr. and Mrs. Johnnie Burson.

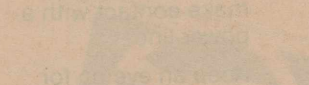

Mrs. P. H. Dugan, Mr. and Mrs. P. H. Dugan, Mr. and Mrs. P. H. Dugan are in Silverton today for a visit with Mr. and Mrs. Johnnie Burson.



Mrs. P. H. Dugan, Mr. and Mrs. P. H. Dugan, Mr. and Mrs. P. H. Dugan are in Silverton today for a visit with Mr. and Mrs. Johnnie Burson.

\$5.00 Each Available at First State Bank or Briscoe County News

First State Bank FFC

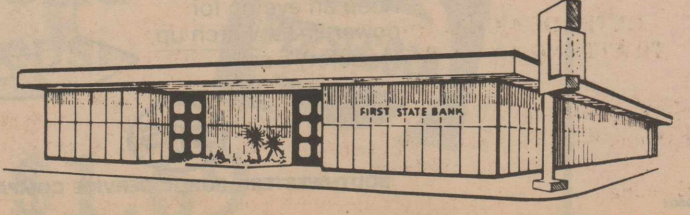

Kniffen-Jones Vows Exchanged Recently

L'Anna Kniffen of Lubbock, daughter of Bettie Sulser, and Jeff Jones of Lubbock, son of Troy and Marge Jones, were united in marriage on Saturday, August 16, 1986 at two o'clock in the afternoon in the home of the bride's mother. Reverend Bill Couch, pastor of Lakeridge United Methodist

Church in Lubbock, performed the ceremony.

The bride was given in marriage by her brother, Dr. Carl Sulser of Tyler.

She wore an ivory tea-length dress with a high neckline trimmed with lace. She wore a wreath of ivory and blue flowers in her hair and wore his mother's cameo necklace. She carried his family wedding bible and wore her mother's pearl earrings.

Her mother was her matron of honor and his father was his best man. Her son, Austin Kniffen, was the ring bearer.

Pianist Carla Walrath of Lubbock played traditional wedding selections.

There was a simple wedding reception in the home following the ceremony, with Cathy Buchanan of Lubbock and Terry Byers of Muleshoe, sisters of the groom, serving cake and punch.

The bride graduated from Springlake-Earth High School and is a hairdresser. The groom graduated from Silverton High School and is employed by D & B Construction Company in Lubbock.

The family will reside in Lubbock.



MR. AND MRS. JEFF JONES AND AUSTIN

School just started: did you remember back-to-school haircuts, perms or conditioners? Summer is almost over and it's time to do things for your hair that were neglected during summer.

Watch for Monthly Specials:

September Special: \$3⁰⁰ tanning Sessions

Short 20-minute sessions in the Wolff System—for the deepest, darkest tan possible

Remember Amy's for the most fashionable styles and the latest products on the market.

Amy's

1006 Commerce Silverton, Texas 823-2555

Down on the FARM

WATCH

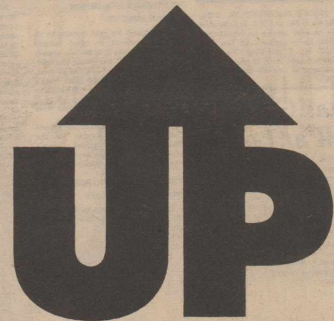

FOR POWER LINES

Power lines can be dangerous.

Touching irrigation pipe to a power line can divert the electricity through the pipe . . . and to anyone in contact with it. In this part of the country, this is the leading cause of farm injuries and deaths in electricity-related accidents. Any equipment of unusual height represents a potential danger. Lift arms on field equipment, combine auger spouts and even radio antennas can cause serious injury or death if they, and you, make contact with a power line.

Keep an eye up for power lines. Watch up, for safety's sake.

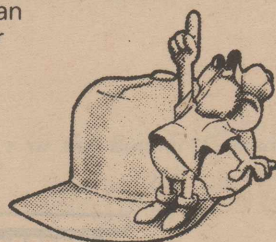

SOUTHWESTERN PUBLIC SERVICE COMPANY

Mr. and Mrs. Strickland Honored In Lubbock

Mr. and Mrs. Chester O. Strickland of Lubbock were honored August 23 when their former students from the Kress Schools, fellow teachers, family and friends gathered for a reunion at the Lubbock Hilton.

Mr. Strickland taught in the high school and his wife taught second and third grades at Kress from 1931-1935.

Guests at the reception included their daughter, Kay Wylie of Albany, Georgia; brothers and sisters, Mr. and Mrs. Alton Strickland of Lubbock, Mr. and Mrs. Henry (Durene) McPherson of Happy, Mr. and Mrs. R. C. (Kathleen) Green of Turkey and Mrs. Einell Montague of Plainview.

Guests attending came from various points in Texas and California, Washington, New Mexico, Arizona, Alabama and Kansas.

Mrs. Strickland wrote the following narrative about her life with her husband.

I was born and raised in Silverton. My parents (the Will Smithees) were two of the first

settlers of Silverton. One granddad had a merchandise store and the other a drug store. I finished high school in 1929. I attended WTSU in Canyon. I had one year with a four-year elementary certificate.

I taught one year at Alexander, a two-teacher school between Tulia and Silverton. I went home every weekend because Chester and I were very serious about our love affair.

I will have to tell you how Chester and I met. His family moved to Silverton in 1926. Chester had just finished high school. His daddy came first to help with the wheat harvest. My best girlfriend, Hazel, and I went to her aunt's to help her cook for the wheat harvest workers. It was here we met Mr. Strickland. Hazel and I thought he was the best-looking man we had ever seen. He had Chester's sweet smile. We rode with him in his truck on every trip back and forth to the elevator.

He told us he had two boys about our age. Hazel was 13 and I was 15. Chester was 18 and his

September 6-7

SHORT CIRCUIT

Rated PG

THE MIDWAY THEATRE

brother 15. Hazel and I were sitting in the choir at a meeting our church was having. We saw Chester and J. D. walk in. I punched Hazel and said, "Kid, there they are."

They took us home that night. It was love at first sight. We both married them. Chester left in September to go to college. I had two more years of high school. Even though I had a boyfriend in high school, when Chester came home he was my first choice.

I took Expression from a speech teacher. I learned many cute pieces to give at times. I was also in the plays. Chester came home many times to see me. Our letters were exchanged often.

On May 31, 1931, Chester and I were married. He was the principal of the grade school at Silverton and I lived there all my life. Most of the people there were kin to me so we invited all of the town to attend our wedding. We married on Sunday at 12:00 o'clock. All of the churches in town dismissed. The church was full and many were standing. We left for Austin to go to summer school. We did this for eight summers.

We taught in Kress the first five years we were married. We rented two rooms from Mr. and Mrs. Wright. He was postmaster at Kress. We always had a special love for Harold and Babe. What fun we had the five years we were in Kress. I taught the second and third grade. I had the sweetest, best students. Wendell Tooley spent the night with us many times. His mother was ill and when his daddy had to go see her, Wendell stayed with us. I used to look at Wendell and would say to myself, "I hope someday to have a son just like him."

The depression and dust storms were bad for all of us. Chester and I directed many plays with the high school students. We had as good a time as they did. The community enjoyed them, too. One play was "Aaron Slick From Pumpkin Creek." Raleigh Elliott had the leading part in this play. He was the old man. To our great surprise the night of the play, Raleigh had a big chew of tobacco. He must have practiced a long time. He spit a long way off and hit a cuspidor with a "pang." You can imagine how we all laughed. Even his pretty darling Irene thought it was real cute.

The students would come by our house and tell us they could go to Plainview to the midnight matinee if we would go with them. We always dressed and enjoyed it as much as they did.

Our five years in Kress were our happiest years. We loved all the students so much.

We then moved to Hart where we stayed one year. We moved to an oil town, Skellytown. It was part of the White Deer School District. We learned many new words from the oilfield people. Chester was elected superintendent of schools at White Deer. Here we had our first home. In 1942 our daughter was born. She was fun for all the school and town. We had been married 11 years so you know how thrilled we were and how much she was wanted.

We moved to Hereford where Chester was superintendent for

See STRICKLAND—

Continued on Page Seven

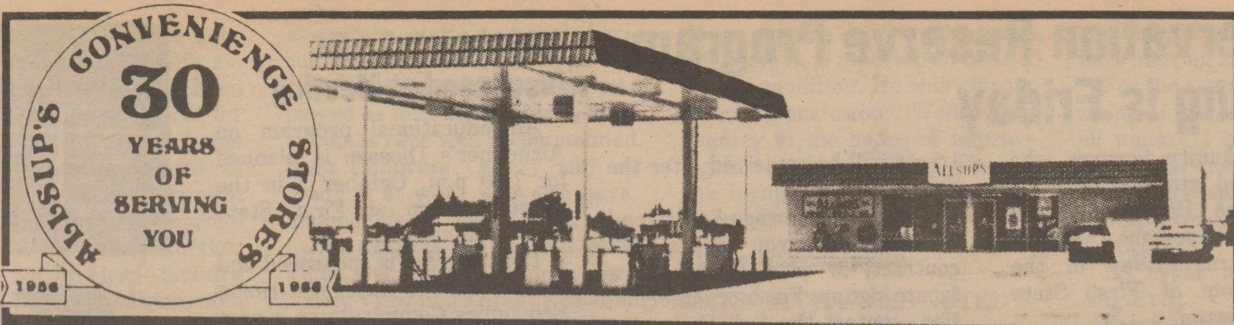

ALLSUP'S CONVENIENCE STORES
30 YEARS OF SERVING YOU
1956 1986

PRICES EFFECTIVE
SEPT. 4, 5, 6, 1986

ALLSUP'S 30 YEAR COMMEMORATIVE

WHILE SUPPLIES LAST
Mug 99¢
FILLED WITH YOUR FAVORITE FOUNTAIN DRINK REFILLS ONLY 49¢



SCOTT ASST. COLORS & PRINTS

Bathroom Tissue 79¢
4 ROLL PKG.



KRAFT CHILLED
ORANGE JUICE
\$1.59
64 OZ. BTL.

ASST. FLAVORS BORDEN'S

Ice Cream \$1.69
1/2 GAL. RND. CTN.

BORDEN'S ASST. FLAVORS

Yogurt 2.69¢
8 OZ. CTNS.

DELICIOUS

Chimachamga

69¢
EACH



FRESH HOT

Burritos

85¢
5 OZ. PKG.

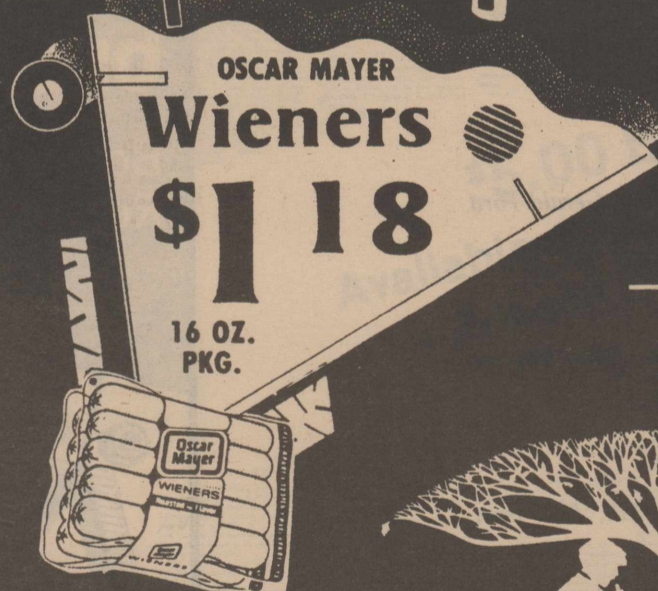

OSCAR MAYER
Wieners \$1.18
16 OZ. PKG.



STORE SPECIAL
ALLSUP'S
Tallsup 39¢
32 OZ. CUP

MADE WITH 99% PURE WATER
ALLSUP'S

Ice

\$1.09



Shurfine Sugar

5 lb. **\$1.39**

Shurfine Charcoal

Briquets **\$1.39**

Glory Rug Cleaner

22 oz. **\$2.69**

Allsup's Bread

2 for \$1.00

**Pepsi-Cola
Diet Pepsi**



12 oz. can 6 pack **\$1.69**

Conservation Reserve Program Meeting is Friday

Briscoe County farmers who have bid land into the Conservation Reserve Program should attend an important meeting at 10:00 a.m. Friday in the Pioneer Room of First State Bank in Silverton.

James Griffin from the ASCS office will discuss how the program will be handled and how payments will be made to participants.

John Crowell from the Soil Conservation Service will discuss the requirements for planting of dead-litter crops, native grass seeding, and other requirements for establishing CRP land to native grass.

A question-and-answer session will follow the presentations by Griffin and Crowell. New con-

tracts will be reviewed after the meeting.

You are encouraged to attend this meeting if you have a CRP contract, or plan to bid in a future signup. For more information, contact the Soil Conservation Service in Silverton at 823-2320.

News From The Ag Shop

After a long three-month vacation, that just started last week, we're off and running again. All systems are go and everything is organized and in place. Ha! It seems we never get all of our goals accomplished and as one teacher put it, "we just start."

Alzheimer's To Be Discussed at Meeting

An educational program on Alzheimer's Disease is planned for 7:00 p.m. October 7 in the Pioneer Room at First State Bank in Silverton.

The program is sponsored and planned by the Extension Home Economics Committee as a part of their efforts to provide families with health-related information.

Becky McGee, a volunteer from Amarillo who presents programs on the disease, will be the speaker. She also has a film on the subject.

Families are asked to mark their calendars on this date if they would like to learn more about Alzheimer's Disease.

There are some faces that won't be seen around here this year, but they won't be forgotten. The new faces offer a new challenge for the faculty and administration. I'm looking forward to a rewarding year.

This year we will continue doing projects that will benefit the school and community. If you know of a worthwhile project that needs to be done, let us know and we will do our best.

Again this year, I extend an invitation to each and everyone; there is always an open door at the Ag Shop.

—Stan Fogerson

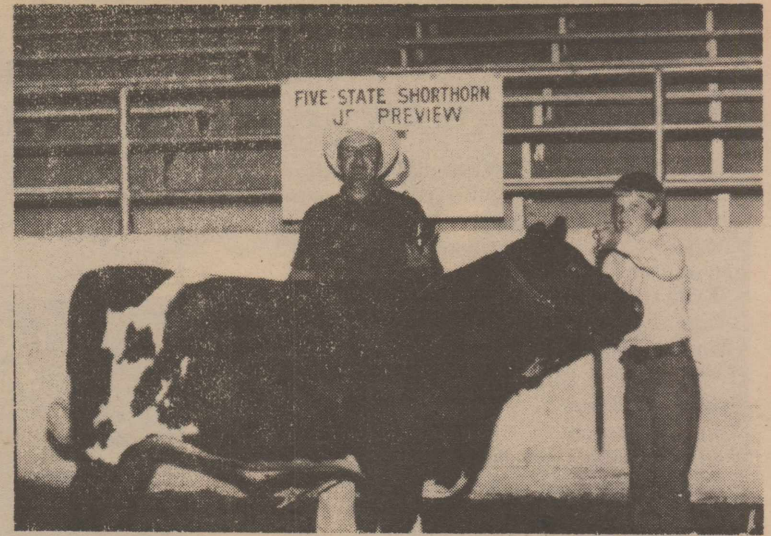

SHORTHORN WINNER—Langdon Reagan won the junior showmanship award at the Five State Shorthorn Junior Preview Show and Futurity Heifer and Steer Show held July 26 at the Texas County Fairgrounds in Guymon, Oklahoma. He also showed the second and third place finishers in Class 2 of the Futurity Heifers. He is the son of Mr. and Mrs. Bennie Reagan.

Junior Girl Scouts Having Membership Registration Drive

It is Junior Girl Scout membership registration time again. The first meeting will be September 8, after school in the Scout Hut (the building behind the John Deere).

A parent or guardian needs to be present to sign forms and go over an outline on what is planned for the year.

To be a Junior Girl Scout, a girl must be in the third grade

(must have been in Brownies) to the sixth grade. The leader is Mrs. Lois Hill and assistant leader is Jeannita Stephens.

Riley Dean Ziegler, a former SHS student received an associate degree with honors in mechanical electrical technology from Texas State Technical Institute in ceremonies held August 15 at the Amarillo Civic Center.

Dean and his family are making their home at Colorado City, where he is employed by Texas Utilities Company.

Quality Doors & Energy-Efficient Windows
Reasonably Priced!

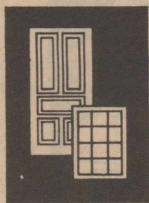

Jenkins

Doors and Windows

Ph. 1-806-372-4336

820 W. 6th
Amarillo, Texas

TX. 1-800-692-4066

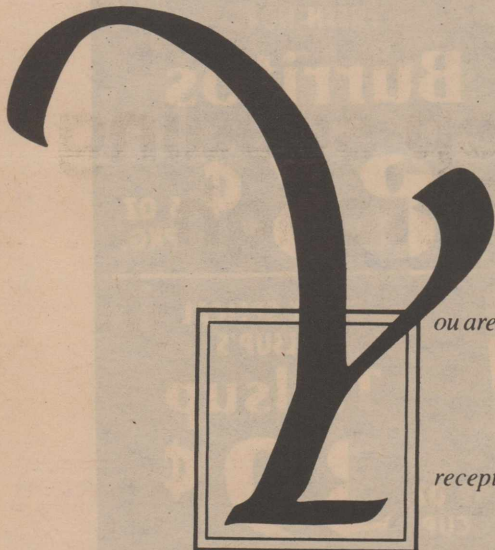

You are cordially invited to attend a dessert

reception with President Gerald Ford

honoring Congressman Beau Boulter

Friday, September 5th, 1986 from

7:30-9:30 p.m. at the Amarillo Hilton Inn

Tickets \$25.00 available at the door or

in advance at the Boulter Campaign

Headquarters ☎ (806) 358-7661.

Paid for by the Boulter Better Congress Club.

Make the Bolt-Eze breakthrough!

Bolt-Eze Sickles and Rivet Replacement Hardware.

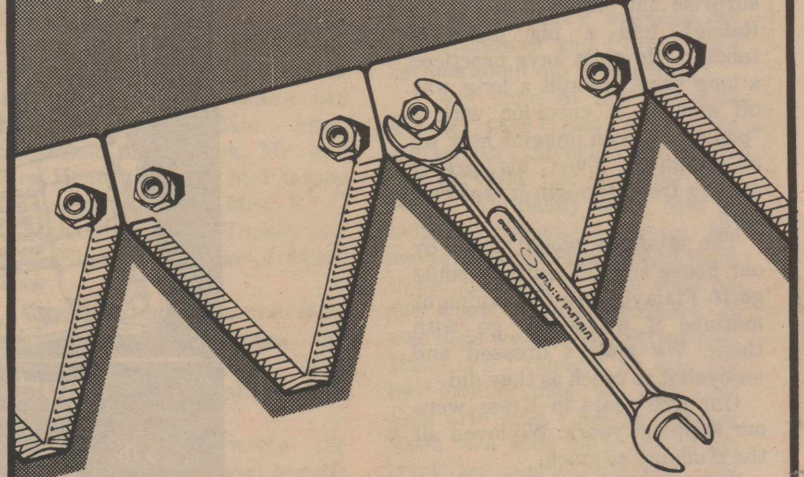

With the Bolt-Eze system you can now replace sections **without** pulling the sickle bar! Special nuts and bolts replace rivets, ending the need to punch rivets. Now available as a complete sickle replacement or individual hardware — for most makes and models.

BROWN-McMURTRY
IMPLEMENT COMPANY

Phone 823-2441

Silverton, Texas



HESSTON

Genuine Heston Parts have the "right fit" at the right price.

Predator Control Program To Be Evaluated Here

The Briscoe County Commissioners will be discussing the feasibility of continuing the current predator control program at 9:30 a.m. Monday, September 8, in the county courtroom.

The program for the past several years has been conducted primarily to control coyotes in Briscoe County. Participating farmers and ranchers have cooperated with the Commissioners to hire a qualified trapper each year. The county has also been working jointly with Floyd County to hire one man to work both counties.

The cost for the previous years has been \$400.00 per county to work with the Texas Predatory Animal Control Board, administrator of the program. In Briscoe County, the Commissioners provided \$100.00 and supporting farmers and ranchers contributed \$300.00 by donation only.

The program will cost \$450.00 per month in 1986-87, due to increased budgetary problems at the state level.

The Briscoe County Commissioners are inviting all interested

citizens to attend the public meeting at the courthouse at 9:30 a.m. Monday, September 8. This will be held just prior to the regular meeting of the Commissioners' Court.

Purpose of the meeting will be to discuss whether or not Briscoe County will participate in the program in 1986-87.

For more information on this matter, interested persons are urged to contact their respective County Commissioners or County Extension Agent Dirk Aaron, 823-2343.



The highest city in the U.S. is Leadville, Colorado. It's nearly two miles above sea level in the Rocky Mountains.

Some people say that greyhounds have the best eyesight of any breed of dog.



GENE WHITFILL
Entomology Service
806-864-3434

If you need work done on your vehicle, just call 995-3565 during the day, or call 823-2039 (Joe) or 823-2150 (Doc) after 7:00 p.m.

They will pick up your vehicle in the morning, drive it to Tullia, make the repairs needed, and return it to you in the evening. Remember, we're just a phone call away!
GRABBE-SIMPSON Motors, Inc.

FRANCIS AERIAL SPRAYING

PESTICIDES APPLIED

Oil - Water
Dried Pellets

Call Alvie Francis 806-847-2523

Adams has reduced prices on their
CHISEL PLOW SWEEPS
and we're passing the savings on to you!

16" Hard Surfaced only \$14.96
18" Hard Surfaced only \$16.99

Premium Quality
Guaranteed

In Stock for Immediate Delivery

BROWN-McMURTRY
IMPLEMENT COMPANY

823-2441

Silverton

HAPPY BIRTHDAY TO...

September 4—Rick Minyard, Lula Bellinger, Gabby Aguilar
September 5—Kayla Coleman, Zane Mayfield, Rita Denton
September 6 — Danny Mac Francis, Amber Loy
September 7 — Terry Grimland, John Gill
September 8—Christa Tucker, Debra Haynie
September 9—DeLyn Patton, Isabel Patino, Lesa Johnson
September 10—Jessie Bomar, Regina Myers, Carol Martin, Heath May

HAPPY ANNIVERSARY TO...

September 4—Mr. and Mrs. David Johnston
September 5—Mr. and Mrs. Jim Myers, Mr. and Mrs. Larry Stephens
September 8—Mr. and Mrs. Wayland Fitzgerald
September 10—Mr. and Mrs. Ben Whitfill, Mr. and Mrs. Billy Settle

STRICKLAND— Continued From Page Five

one year.
We left Kaynelle with our folks and went to Denton to find some teachers for Hereford. Chester went to the placement bureau. The man told him that the superintendent's position was open. Chester took the name of all the board members and went to see them. He came back to the hotel where I was. I went with him to see all of them. We went back to Hereford, and in a week they called him to say he had been elected superintendent of the Denton schools. We went to find a home and moved in July 1946. Chester was superintendent there 23 years.

Kaynelle was three years old when we moved. We stayed in Denton 35 years. All of those years were a pleasure. Kaynelle finished high school in 1960. She was married in 1962. She took her degree from North Texas State University.

Now about our grandchildren and son-in-law. Lynn had his master's degree in engineering from the University of Tennessee. They have three darling children, live in Albany, Georgia. Sherri, 22, the eldest, is working on her masters in Georgia Southern College. She will teach three math courses in the college this coming year. Roger is 20 and is Auburn University. He is majoring in Engineering. He is an excellent student. Cliff is 16 and has two more years in high school. He makes all A's. We are so proud of all of them. They are all three sweet good Christians.

In 1981 we decided to move to Lubbock. We wanted to be near our brothers and sisters and families. We have loved all of them.

Among honors accorded the Stricklands were when Strickland Junior High School in Denton was named for Chester; she was president of the Denton District, Woman's Society of Christian Service; each of them has held or served most every position in the churches in every place they have lived; he was president and served on all the committees of the Denton Kiwanis Club during his 30-year membership; she was president of the leading women's study club; he was chosen by the Chamber of Commerce as "Man of the Year" in 1969; both served

as president of the Knife and Fork Club in Denton; he was a director of Denton Savings and Loan Association for several

years.

Over 100 attended the special appreciation banquet for the Stricklands in Lubbock.

Furniture Restoration

If you are looking for a complete professional furniture restoration job, why not call a "pro" with 20 years' experience?

**Rush and Cane Seating - Veneering
Old Trunks - Vat Stripping**

J. R. STEELE
806 823-2097

900 Braidfoot Street
Silverton, Tx. 79257

BALER TWINE

1986 TWINE PRICES REDUCED

Blue and White (20,000 ft.)	\$19.75
Red and White (20,000 ft.)	\$16.15
MS160 (9,600 ft. for Square Baler)	\$21.00
Sisal Twine (10,000 ft.)	\$19.25

823-2441

Brown-McMurtry Implement

**Get precise,
deep seeding
through
heavy trash**

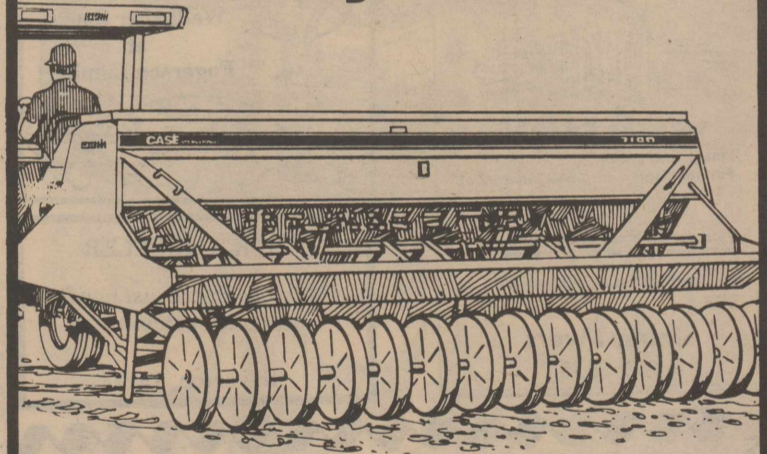

Case International 7100 Shovel Press Drill

Ideal for big-acreage dryland seeding. Drills right down through trash and hard pan... puts seed in loose, moist soil... hardly disturbs ground cover. Narrow-shank high-speed openers put seed down to 8 in.

- Plain hopper holds 2.4 bu. per ft.; combination with two grain/fertilizer ratios.
- Big 20" press wheels deliver good firming action.
- Openers staggered 22" apart for good trash flow.
- IH precision feed cups with new tapered metering edge for unmatched accuracy.
- Sealed, regreasable press wheel bearings for longer life.
- Seeding widths from 8 to 14'; multiple hitches with optional hydraulic marker for up to 56'.



Come in and see the complete line
of Case International drills.

DON BROWN
Home Phone (806) 823-2292

DAVID REAGAN
Home Phone (806) 823-2537

BROWN-McMURTRY
IMPLEMENT COMPANY

Phone 823-2441

Silverton, Texas

PLAY IT SMART... GET INTO
THE CLASSIFIEDS

For Sale

MAYTAG WASHERS AND Dryers For Sale. Service and Parts. Fogerson Lumber & Supply. 13-tfc

SCANNERS: KEEP INFORMED on weather conditions. Grabbe-Simpson Motors, Inc., Tulia. 24-tfc

TRASH BARRELS FOR SALE: Silvertown Fire Department. Ask at City Hall. 31-tfnc

FOR YOUR ELECTRIC FENCING needs, see Brown-McMurtry. We have battery, hi line or solar powered fencers. We also carry insulators, gate handles and wire. 46-tfc

WATKINS PRODUCTS FOR Sale in Silvertown. Briscoe County News, 508 South Main Street, or call 823-2333. 41-tfnc

KIRBY VACUUM CLEANERS Sales & Service, Bags & Belts. John Bowman, 823-2313. 17-tfc

RENTALS
Video Home Movies and Players
VCR and Beta
Overnight or Weekends
BROWN HARDWARE

Don't gamble



with HAIL
Insure today with Farmers Union crop hail insurance!

NATIONAL FARMERS UNION
PROPERTY & CASUALTY COMPANY

for complete insurance needs SEE
Jimmy Myers
847 2675

SHELLED, CRACKED OR Whole Pecans. 823-2021, Fogerson Lumber & Supply. 50-tf

GOOD ALFALFA HAY FOR Sale: Small bales; stored in barn. 823-2038. 52-tfc

FOR BIRTHDAY CAKES* Cake Donuts and Cookies for special occasions, call Lee at 847-2624. 13-tfc

WHEAT SEED FOR SALE. Cleaned, sacked and double treated, or in bulk. Robert McPherson, 847-2501. 34-6tc

1976 CORDOBA FOR SALE: Good condition. Gene Whitfill, 864-3434. 32-tfc

7100 IHC HOE DRILLS 3 - 14 ft. with transport hitch; excellent condition, \$13,500. Briscoe Implement, 823-2486. 35-2tc

THREE IRON BEDSTEADS For Sale. 823-2227. 36-1tc

Wanted

WANTED: WILL DO IRONING for the public. Call 823-2071. 36-1tp

SUZUKI VIOLIN LESSONS Available in Plainview. Ages 4 and up. For more information and possible car pooling, call 847-2633. 36-2tc

TERRY GRIMLAND WELDING
Shop - Portable - Aluminum Welding - Small Engine Repair - Dealer for Nichols Sweeps & Tillage Tools
823-2214

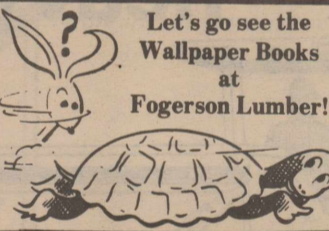

Let's go see the Wallpaper Books at Fogerson Lumber!

RICK'S MUFFLER
For all your exhaust needs, including customizing.
Silvertown, Texas

Tiffin Talk

We have saddle slickers, hat protectors, irrigation boots, four- and five-buckle overshoes. We have denim and chambrey skirts for juniors and misses. New fall merchandise arriving daily. Our summer fabric is \$1.49. L'Anna and Jeff Jones have selected items from our store. Tiffin's Dept. Store. 36-1tc

BACK-TO-SCHOOL TANNING Special: 20 - 30 minute sessions, \$50; 30 - 30 minute sessions, \$70. Shear Delight Beauty Salon. Call for an appointment today, 823-2468. 35-2tc

IS SOMEONE'S DRINKING causing you a problem? Call Al-Anon, 823-2160. 30-tfnc

For Rent

FOR RENT: VERY NICE 3-bedroom home, two baths, washer-dryer connections, dishwasher, disposal, range, all carpet, drapes, patio, two-car carport, fenced yard. Available now. Troy Jones, 792-9409, or Glenn Jones, 823-2123. 29-tfc

Real Estate

BRICK HOME FOR SALE OR Rent: Three bedrooms, two baths, utility and basement. Gene Whitfill, 864-3434. 32-tfc

SMALL 2-BEDROOM HOME For Rent or For Sale: 702 Braidfoot. 823-2352. 35-5tp

THREE-BEDROOM HOUSE For Sale. Two full baths, lots of storage. \$10,000. 706 Main. Call 823-2108. 36-tfnc

REAL ESTATE FOR SALE

Mildred Crum Home 906 Pulitzer—\$29,500
*
705 Braidfoot—\$22,500
*
902 Pulitzer—\$31,000
*
1007 Lone Star—\$20,500
*
Thurman Home—906 Braidfoot \$17,500
*

SINGER REAL ESTATE

Tulia 995-4371
Nights and Weekends 995-3128
34-4tc

TWO BEDROOM, ONE BATH Home with large attached garage; carpet and drapes. See Verlin Towe or call 214-262-7267. Reasonable. 4-tfc

LOCKNEY MEAT CO.
Kill Days Monday through Friday
CUSTOM PROCESSING
Half and Quarter Cut, Wrapped, Frozen and Fully Guaranteed
SAM & KELLY FORTENBERRY
652-3305
Corner of U. S. 70 and Farm Road 378 South
11-tfc

Services

HAVE YOUR HAIR Completely reconstructed in only 30 minutes. These new products completely rebuild damaged hair due to chemical overprocessing, heat appliances, sun and wind. The results are unbelievable. Come by 1006 Commerce or call 823-2555. (Demonstrations are available for clubs and organizations or just family and friends.) Remember AMY's for the most fashionable styles and the latest products on the market. 36-3tc

MONUMENT SALES & SERVICE. Schooler-Gordon Funeral Directors, Silvertown, 823-2121; Quitaque, 455-1313. 36-2tc

SINGER SEWING MACHINES, Vacuum Cleaners, Smith Corona Typewriters, Adding Machines, Kirby Sales and Service. Buy here, service here. Call in Silvertown, 823-2333. Office located at 620 Noel in Memphis, 259-2716. Here every two weeks on Thursdays. 21-tfc

Public Notices

The undersigned hereby gives notice of application for change of address only to the Texas Alcoholic Beverage Commission, Austin, Texas for private club registration permit, previous address being 515 Commerce Street, Silvertown, Briscoe County, Texas, to be relocated at 408 Main Street, Silvertown, Briscoe County, Texas. Said private club still to be operated under name DJ's. Officers are as follows: James R. Edwards, president; Donna J. Edwards, secretary-treasurer. 35-2tc

PUBLIC NOTICE

A 1987 County Budget Hearing will be held at 10:00 a.m. September 8, 1986 in the Briscoe County Courtroom in Silvertown, Texas by the Commissioners' Court.
Fred W. Mercer
Briscoe County Judge
36-1tc

Cards of Thanks

I would like to thank everyone for the cards, letters and prayers in my behalf while I was in the hospital and since I've been home. They were all greatly appreciated.
Merl Oneal

There are so many "thank you's" we want to say that we do not know where to begin. Alvin and I appreciated the Historical Society selecting us as the pioneer couple of the day. If my brother could have been there he would have enjoyed seeing his old '32 Buick in the parade. We enjoyed the lovely luncheon with the class of '36, fellow teachers and friends. We enjoyed visiting with many friends. I especially enjoyed the many greetings and good wishes from ex-students. From the paper, I saw that there were many friends there that I did not see. It made me very unhappy to know I had missed seeing them.

It was such a nice day—one to be long remembered. I know many people worked hard to prepare the program, parade, barbecue, luncheons and all the other delightful events of the day. We hope to see all of you in 1988.
Alvin and Winnie Redin

We would like to express our appreciation for the food, prayers and concern everyone has shown while I was in the hospital and at home. God bless you all.
Bryan and Lana Burson

The family of Stella Cearley would like to thank everyone for their kindness and concern during the loss of our loved one. We appreciate all the food, flowers and prayers during our grief. A special thanks to the ladies who served us lunch.

Odelia Stidham and family
John D. and Lessie Baird and family
W. D. and Maxine Graves and family

WHEAT SEED FOR SALE

Ray Teeple
Phone 847-2620

Johnson's Gin Co.

"Your Business and Friendship Appreciated"

Rex Johnson

[806] 823-2224

P. O. Box 717

Silvertown, Texas 79257

P. O. Box 771

806 823-2074

ZIEGLER PUMP

Silvertown, Texas 79257

Domestic, Irrigation and Windmill Work

RILEY ZIEGLER
806 847-2627

JERRY MILLER
806 823-2167

BRAD ZIEGLER
806 823-2242

LET US HELP YOU
WITH YOUR FERTILIZER
AND CHEMICAL NEEDS

**BRISCOE
COOPERATIVES**



This Is Your Business-

Use It!