



Contested Races Saturday Election

April 3, will be held in Knox City for School Board, Board elections; one of the three contested. Site of the election will be the Community Center in Knox City.

Min Plates Show

FFA will be holding its first FFA Friday, April 2, at the Ag Shop. The Ag Shop will have a show of broilers will Grand and Region honors. Andy Hale, chapter president, is sponsoring the event.

Participants this year are Kenneth Reed, Ted McEstrada, Johnny Carver, Dicky Pierce, and Pedro Estrada.

Graveside services were held at 3:00 p.m. Saturday in the Nocona Cemetery in Nocona with Smith Funeral Home in charge of arrangements. Bill Yeager, Nocona City Manager, officiated.

Mr. Magee, 64, died at 5:45 a.m. Thursday in the Knox County Hospital after an illness of five months.

Born August 9, 1911 in Montague County, he married Ruby Nix on June 9, 1928 in Denton. He retired as a mechanic repairman with Texaco in 1972 after being with the company for 22 years.

Survivors include his wife, Ruby of Knox City; two daughters, Mrs. Leona Burkham of Knox City and Mrs. Claudia Snow of Loving; and six grandchildren.

Pallbearers were Pete Ellison, Elwood Hackney, Jim Dillon, John Crossover, Raymond Wilhite, and Clifford Cornett.

Gray of Graham, of the West Central Riding Horse Association, expressed appreciation for the excellent turnout of riders and thanked the ranch which furnished the cattle for both the Knox City and the Ranchers Cutting show. A brown gelding was shown by Joey Carver of the Ranchers Cutting show. A brown gelding was shown by Fred Carver of the Ranchers Cutting show. A brown gelding was shown by Fred Carver of the Ranchers Cutting show.

Mrs. Opal Denton Home From Hospital

Mrs. Parker Denton returned to her home here Friday after spending the past several weeks in Hendrick Memorial Hospital in Abilene.

Opal reported that she is feeling better but will have to rest at home this week and next before she will be able to return to work in her beauty shop.

Democrats Set Workshop Tonight

All Democrats are reminded of the workshop seminar to be held here tonight (Thursday) at the Knox City Country Club beginning at 7:00 o'clock.

Charles W. Stenholm, co-chairperson of the Region 8 Affirmative Action and Voter Participation Committee of the Texas Democratic Party of Texas announced that all Democrats would be welcome and that there will be no charge for the seminar.

Topics will be the new presidential primary; new rules as related to precinct and county conventions; precinct organizations; the new voter registration law; and the use of campaign volunteers.

Stenholm pointed out that this is the first program of its type in the history of the Democratic Party of Texas, and is a massive program to encourage participation by the grassroots Democrats and the traditionally under-represented minorities to train them to be effective political participants.

An Open Letter

Dear Mrs. Angle:

We would like to take this opportunity to express our appreciation of a man who has passed from our community.

Bill Magee is gone now, but his memory will always be with us. His life, attitude, and example were such that all mankind could follow.

For the many hours that he gave in supporting our athletic program, we are grateful.

Mr. Magee is gone, but we hope we can adopt some of the standards by which he lived.

Our best wishes go to Mrs. Magee and the family.

Sincerely,
Knox City Greyhounds
and Coaching Staff



GREETING STATE REP. W.S. (BILL) HEATLY, third from left, on his arrival last Friday to speak to the Knox County Retired Teachers Association were from left, Supt. W.R. (Bill) Baker, Mrs. E. Hob Smith, program chairman, Mr. Heatly, and Mrs. Curtis Casey, association president.

Retired Teachers Hear Rep. Heatly

"I believe our nation's Bicentennial year has brought persons closer together and aroused more patriotism than anything in our lives," State Representative W.S. (Bill) Heatly told members of the Knox County Retired Teachers Association and their guests Friday afternoon at the Community Center.

The veteran legislator from the 101st District reviewed his early schooldays and saluted the retired teachers. He also noted the progress education has made and said he felt that a great heritage had been left for all of us in the three R's.

He expressed his preference for a small town and said that he had never been sorry that he chose a small town such as Paducah in which to rear their three sons. He had great praise for the "Father of our Country" and said that he felt that George Washington lived in the will of God as everything he did was with the Almighty in mind. Next to George Washington, he

named Harry S. Truman as "one of the greatest" as he made his decisions in the interest of his people, and according to Rep. Heatly, when a person does this, he will always be right.

He stressed the fact that any organization, town, country, state or nation will fall without leadership and that he hoped that we could gain the leadership our nation needs.

He concluded with a word to the retired teachers as to the influence they can have in the state. He also discussed briefly the Social Security position in retirement.

The introduction of the speaker was made by Supt. W.R. (Bill) Baker, who related that Rep. Heatly had always been a friend to Knox City and this area. Mr. Baker was introduced by program chairman Mrs. Lois Smith.

A short business session was conducted by Mrs. Virginia Casey, president. Patriotic songs were sung

by the group with Mrs. Sammie Carpenter as song leader and Mrs. Mabel Pyatt at the piano.

Hostesses were Mrs. Mary Groves and Mrs. Gladys Reed.

Students Win UIL Events

Knox City literary contestants traveled to Vernon Regional Junior College in Vernon Monday and Tuesday of this week to participate in the District UIL competition but failed to pick up enough points to repeat their district win from last year.

On Monday, the two debate teams consisting of Jodie McGaughey and Junior Gonzales, and Breet Boone and Mark Clonts won second and third places respectively.

Tamie Grindstaff placed second in typing and David Anderson took third place in number sense.

In journalism competition on Tuesday the judge was unable to be there due to illness, so results will not be known until Thursday (today).

Students who placed in the top three categories will participate in regional competition at Texas Tech University in Lubbock on Saturday, April 24.

FLBA Members Back From Meet

J.E. Nix of Jones County has just returned from Houston where he represented the Federal Land Bank Association of Haskell at the annual stockholders meeting of the Federal Land Bank of Houston.

The meeting, held at the Houston Oaks Hotel, was attended by members of 66 Federal Land Bank Associations in Texas. There were about 550 persons in attendance.

George Cunningham, president, in his annual report to stockholders, reported that the demand for new loans declined from the previous two years; however, 1975 was still the third largest year in the bank's history and also the third consecutive year that loan closings had exceeded \$200 million. Dr. Phil Gram, economist on leave of absence from Texas A&M University and B.K. Johnson, a prominent South Texas rancher and director of the King Ranch Corporation, also addressed stockholders and guests during the meeting.

The Federal Land Bank of Houston makes long-term loans on farms and ranches throughout Texas and currently has \$1.4 billion in loans outstanding.

See FLBA Pg. 3

Dr. R.G. Howell To Close Practice Here

Dr. Robert G. Howell announces the closing of his practice here in Knox City effective May 31, 1976.

In a release to the News Monday of this week, Dr.

Howell stated, "It is with deep regret I am having to do this, but I feel it is necessary to consider the needs of my family."

"I feel confident another physician will be obtained to take over my practice by the time I leave."

"If a physician is not found by the time of my departure, I will make arrangements for your medical records to be transferred to a physician of your choice."

"It is with deepest regrets that I am having to leave my friends and patients of 13 years. However, I feel this decision is best at this time."

Barrel Races, Calf Roping Slated Here

The Brazos Valley Recreation Association of Knox City is having jackpot barrel races and calf roping at its arena located on the O'Brien highway Sunday, April 4, and the following Sunday, April 11.

Books close at 1:15 p.m., with activities to begin at 1:30 p.m.

Top barrel racers and ropers from throughout this area will be competing here.

Two open jackpot barrel races are slated, as well as one junior barrel race, which is for riders 14 years old and under.

In addition to a three calf jackpot open to all ropers, a two calf jackpot will be open to ropers 18 years old and under.

KC Band Boosters To Meet Monday

The next regular meeting of the Knox City Band Boosters has been scheduled for Monday night, April 5, at 7:30 o'clock in the Band Hall.

According to Mrs. Jeff Graham, president, it is an important meeting and everyone is encouraged to attend. She said she was especially hopeful that all officers would be present.

Annual CofC Banquet Set Thursday, April 8

Mark Thursday night, April 8, 7:30 o'clock on your calendars right now and plan to be present in the school cafeteria for the eleventh annual Chamber of Commerce banquet in Knox City.

Tickets went on sale Monday of this week and are available at Jones Pharmacy, the Chamber office, or at the door, according to Mrs. Doris Crossover, secretary-manager.

Plans call for a Bicentennial theme and banquet guests will be treated to an after-dinner speech by State Representative W.S. (Bill) Heatly, Knox City's good friend and representative for the 101st District.

Rep. Heatly's legislative district is the largest in the state with 15 counties, including Baylor, Cottle, Crosby, Dickens, Foard, Garza, Haskell, Kent, Knox, Shackelford, Stonewall, Throckmorton, and Wilbarger.

Plans call for a Bicentennial theme and banquet guests will be treated to an after-dinner speech by State Representative W.S. (Bill) Heatly, Knox City's good friend and representative for the 101st District.

Rep. Heatly's legislative district is the largest in the state with 15 counties, including Baylor, Cottle, Crosby, Dickens, Foard, Garza, Haskell, Kent, Knox, Shackelford, Stonewall, Throckmorton, and Wilbarger.

Plans call for a Bicentennial theme and banquet guests will be treated to an after-dinner speech by State Representative W.S. (Bill) Heatly, Knox City's good friend and representative for the 101st District.

Plans call for a Bicentennial theme and banquet guests will be treated to an after-dinner speech by State Representative W.S. (Bill) Heatly, Knox City's good friend and representative for the 101st District.

Plans call for a Bicentennial theme and banquet guests will be treated to an after-dinner speech by State Representative W.S. (Bill) Heatly, Knox City's good friend and representative for the 101st District.

He has been a state representative since 1954 and a longtime influential member of the Texas Legislature.

The lawyer-farmer has served 18 years on the House Appropriations Committee, much of that time as chairman, and has been on the legislative budget board either as a statutory or an appointed member for 20 years.

Martha Jones, Knox City pharmacist, will be installed as president, succeeding David Counts, along with new directors Sam E. Clonts, John McGaughey, and Buford Wright. Brett Boone is new youth director. Holdover directors include Alton Hester, Tommy Richardson, J.B. Tabor, Pete Ellison, Bill Baker, and youth directors Kelly Robinson and Jimmy Lynn who is retiring this year along with Counts and Billee Angle.

Mrs. Vera Newton's home-making department will cater the banquet and entertainment will be provided by Timilu Graham and Patti Counts.

New Residents For Knox City

Mr. and Mrs. Earl W. Webb are among the new residents of Knox City, moving here March 1 from Stanton.

Mr. Webb is employed as maintenance man for Continental Oil Company and has assumed the duties of the late N.L. McHam.

Mr. Webb is a native of Hamlin and his wife, Royce, is from Jacksonville, Florida. They are the parents of two children, Tommy, 3, and Shelba, three months old.

They live at 927 Aspen and attend the First Baptist Church.

Another new resident is Nancene Barrett who moved here in January from Abilene to assume the managership of Pioneer Oil Co. The new resident was born in Eastland. She lives near the station and attends the Four-square Church here.

To Archer City Fri.

Hounds Take Third Win In Olney

Knox City tracksters wrapped up another first Saturday in the Olney Relays as they amassed a whopping 182 points to capture top Class A honors. Closest to KC was Holliday who totaled 134 points for second.

Hurdler Jimmy Lynn took advantage of the brisk day and raced to a record-setting 41.0 in the 330 yard hurdles as did Class AAA David Ray of Burk Burnett who shared the record. Lynn also won in the 440 relay, the mile relay and took third in the long jump with a 20'8" jump.

Al Bateman was up to his old ways winning the 100 yard dash with a time of 10.7, the 220 yard dash in 22.9 seconds, and was on the winning 440 relay team that clocked a time of 44.7. Bateman also took second position in the long jump with a leap of 20'11".

In addition to Bateman's win in the 100 yard dash, Charlie Flye and Flint Richardson, who took second and third places respectively in the race, kept this win all to themselves as they did with the 220 yard dash. Again, it was 1-2-3 for the Hounds with Bateman, Flye and Richardson. These three speedsters along with Lynn make up the 440 relay team.

More of the Hounds had a good day in Olney including Tim Whitten, who placed second in the high hurdles, third in the intermediate hurdles and was also on the mile relay team that came in second.

Bill Reynolds took first place in the pole vault, second in the 880 yard dash, and was also on the mile relay team.

Weight man Rusty Grimsley took second and third places in the shot put and discus competition.

Tommy Mangis took third in the 120 yard high hurdles. According to Coach Jimmy Rogers, several of the younger kids including Tommy Mangis, Eddie Martinez, Butch Johnson, Raul Espinosa, David Anderson, Phillip Rhodes, Jimmy Rushing, Mark Clonts, and Kelly Robinson did a good job in rounding up total points for the Hounds.

Due to illness, Jerry Eaton and Ricky Bishop did not compete in Saturday's meet. Winning other divisions of the meet included Rochester in Class B; Breckenridge in

Did You Know

that Mrs. Bess Benton, 413 North 15th Lamesa, Texas 79331 subscribes to The Knox County News?

Weather

FURNISHED BY PLANT MATERIALS CENTER
4 Miles NW of Knox City

date	low	high	rain
3-24	53	86	
3-25	55	90	
3-26	41	71	
3-27	33	73	
3-28	56	77	.02
3-29	44	74	
3-30	38	61	

KC NEEDS A PHYSICIAN!

WANT... TO BUY? TO SELL? RESULTS?

WANT ADS

...WILL WORK FOR YOU!

Do you need to save !!!
STATE FARM AUTO INSURANCE 15%.

STATE FARM Home Owners 20%.

6% Interest on new car financing including SERVICE LIFE for term of loan.

LIFE INSURANCE with Dividends up to 75% by the 23rd year.

LEO FETSCH INSURANCE 422-4259 in Munday 10-23 tlc

SEE YOUR MONUMENTS before you buy. More than 50 designs to choose from. Also curb work. J.C. McGee. 10-21 tlc

WATER WELL DRILLING irrigation and domestic, also test pumping. Call W.P. Hise, Haskell (817) 864-3727. 1-8 tlc

PUMPS--Irrigation - Domestic - Formation testing - Well Drilling - We pull and repair all type pumps. Rea Pump Company. Throckmorton Highway, Haskell, Tex. Call 24 hours, 817-864-3372, or locally, Hester Irrigation 658-3918. 3-25 tlc

PLOW DISCS, Chisel Sweeps and Spikes, Servis Shredder Parts, Bearings for all makes. Few belts. EGENBACHER IMPL., 658-3242. 8-21 tlc

FOR SALE - Two benches and table. Converts to camper bed. Call 658-3433. 4-1 tlc

NICE, LARGE, WELL KEPT two bedroom brick home. Large den and living room, utility room, rock fence and double carport. Excellent location. Call David Counts or Barney Arnold at 658-3211. 4-1 tlc

EXPERIENCED WELDER needed. Apply Seymour Machine Shop. Phone 888-3126 or 888-2087. 4-1 tlc

HAND DECORATED Stationery, folders, cards, package enclosures and napkins. Embossed, stamped and colored for many occasions. Reduced prices. Call 658-3100. 4-1 tlc

FOR SALE - Three bedroom red cedar house. Located about one-quarter mile from southwest shoreline of Lake Texoma. If interested call 817-454-2041. 4-1 tlc

TWO FAMILY CARPORT sale - April 3, new and used clothing. Boy's suits in excellent condition. Boy's bicycle, table and chairs, odds and ends. 705 Aspen. 4-1 tlc

UNUSUAL GREEN PLANTS, Flower Pots, and Macrame Hangers. See at the Mini Mall. 4-1 tlc



HAIL SEASON

Hail Season for growing crops is here. Protect your investment and income against loss from Hail damage.

Hail insurance is easy to obtain at low net-cost - a dividend has been paid to Crop Hail Policyholders four of the past five years. Just call your Farm Bureau Insurance Agent.

Bob Bohanon
Knox County Farm Bureau
Munday 422-4131
422-4171



PUBLIC NOTICE

NOTICE OF ELECTION

An election will be held at the Courthouse Assembly Room in Benjamin, Texas on April 3rd, 1976, for the purpose of electing two members to the Board of Directors of Knox County Water Control and Improvement District #1. Candidates filing for the places are Jack C. Idol and B.B. Benson.

Election Judge will be Clodell Duke with Jan Pollack as Assistant Judge. Polls will be open from 8 a.m. to 7 p.m. B.B. Benson, President of Board of Directors of Knox County Water Control & Imp. Dist. No. 1

3-18 3tc
FOR SALE-Three bedroom, two bath house, corner lot, water well, 1200 South third. Phone 658-3764. 3-18 tlc

FOR SALE: Three bedroom house. Carpet, new cook top and oven. Garage. Call Barney Arnold or David Counts, 658-3211. 3-25 tlc

BAYLOR MILLING CO. Throckmorton Highway, Seymour. Custom Mixing - Pelleting--Your grain or ours. Range cubs, creep feeds, hog feeds, start to finish. 888-3921 10-10 tlc

HANNAH'S HUSBAND hates hard work, so he cleans rugs with Blue Lustre. Rent electric shampooer, \$1. City Hardward. 4-1 tlc

DO YOU HAVE any questions concerning the use or operation of your CB radio? If you would like answers to these questions come to the Munday Community Center Tuesday, April 6, at 8 p.m. The Knox County CB Association is having a question and answer session conducted by a well-known CB operator from Wichita Falls. All CB operators or interested persons are welcome to attend. 4-1 tlc

FARM & RANCH WELDING, portable welder. Building pipe for sale, different sizes. Will build pens and barns. Call Homer Rolston, 817-454-3341. Benjamin. 1-16 tlc

AVISO DE ELECCION

Se llevara a cabo una eleccion, en el edificio de la Corte, (salon de asambleas) en Benjamin, Texas. El dia 3 de Abril de 1976, con el proposito de elegir dos directores para la junta directiva del Departamento de Control de Aguas y Mejoras del Condado de Knox, Distrito No. 1.

Los candidatos postulados son: Jack C. Idol y B.B. Benson. Como juez de la eleccion serfa: Clodell Duke y como asistente del juez Jan Pollack. Las casillas de votacion estaran abiertas al publico de 8 a.m. a 7 p.m. B.B. Benson, presidente de la junta directiva del Departamento de Control de Aguas y Mejoras del Condado de Knox, Distrito No. 1

3-18 3tc
HAY FOR SALE: Phone 658-3868--Dewey or Marie Darr. 3-25 tlc

FOR SALE--Two lots on South Fourth West. Call 658-3696. 3-4 tlc

I will not be responsible for any debts other than my own. Earl W. Duke. 3-18 3tp

GOLFERS--Used set of woods for sale. Call Alton Fitzgerald, 658-3241 or after 5 at 658-3865. 4-1 tlc

FOR SALE--1969 Plymouth. Loaded, air conditioner and other extras. Call Alton Fitzgerald, 658-3241 or after 5 at 658-3865. 4-1 tlc

FOR SALE: Set of Firestone Champion Delux Belted Tires. Size 825 X 15 G-78. off my new pickup. Take all four for \$100. Roy Baker - 658-3931. 3-25 2tc

CARD OF THANKS We would like to take this means to express our sincere thanks for the many acts of kindness extended during Opal's illness.

We appreciate so much the prayers, flowers, gifts, cards, phone calls and visits, and these will always be remembered by us and our family. Opal and Parker Denton 4-1 tlc

THAT IN ACCORDANCE WITH SECTION 30.05 OF THE PENAL CODE OF TEXAS - CRIMINAL TRESPASS (SENATE BILL 111 PASSED BY THE 62nd LEGISLATURE). NOTICE IS HEREBY GIVEN THAT ALL LANDS OF THE W.T. WAGGONER ESTATE ARE POSTED SAVE AND EXCEPT WHERE WRITTEN PERMISSION IS GIVEN TO COME UPON THE SAME.

KILLEN M. MOORE TRUSTEE 3-11 tlc

ELECTROLUX Representative: I am your sales representative for Electrolux Cleaners and supplies. Mrs. Alvin Hollar, 511 North 7th Street, Munday, Texas. Phone 422-4048. 3-25 3tp

BRACE YOURSELF for a thrill the first time you use Blue Lustre. Rent electric shampooer, \$1. Perry's, Knox City. 4-1 tlc

CLASSES by Harold Scott of Sayre, Oklahoma, Oil Workshop, April 5-9. The Art Stall, Mini Mall, Phone 658-3957. 4-1 tlc

CB DISCOUNT CENTER - SPECIAL of the week - Xtal XCB-7, 23 channels, list price - \$179.95--Our price, \$139.95. All other CBs at similar savings. 204 E. Hamilton, Stamford. 4-1 tlc

FOR SALE: House, 5 rooms and bath, and Trailer Park with double bath house, on lots 13, 14, 15, Block 51, Original Survey City of Knox City, Phone (806) 799-8102 or 795-1697, Lubbock, Texas. 9-11 tlc

IF YOU NEED FERTILIZER, see Herbert Bellinghausen or call 658-3817. 12-18 tlc

EXTRA CHEAP YARD SALE sponsored by the O'Brien Baptist Young People on the parsonage lawn all day Saturday. 4-1 tlc

FOR SALE: Hoover (new) Shampooer, Waxer, polisher with all Brushes--Less than 1/2 price. Also 1 Mantle Lantern - used 1 time-\$12.50. Call 658-3222 4-1 tlc

Political Calendar

The Knox County News is authorized to make the following political announcements, subject to the action of the Democratic Primary in May. All political advertising must be paid in advance.

For State Representative 101st Legislative District **W.S. [BILL] HEATLY** (re-election)

For District Judge 50th Judicial District **R.J. [JUDSON] BALCH** (re-election)

For District Attorney 50th Judicial District **W.H. HEATLY** (re-election)

For Sheriff, Knox County **H.C. STONE** (re-election)

For Tax Assessor-Collector Knox County **JOHN A. SMITH** (re-election)

For Commissioner, Prec. 3 Knox County **R.C. DANIEL** (re-election)

For Commissioner, Prec. 1 Knox County **C.C. [BUDDY] ANGLE**

CHARLES LANKFORD
BILLY GENE JOHNSTON
CHARLES RAY SMITH

For County Attorney Knox County **BOBBY D. BURNETT** (re-election)

STREAMS IN DESERT PLACES

By Ozelle Stephens

"Blessed are you when men shall revile you and persecute you and shall say all manner of evil against you falsely, for my sake. (Matthew 5:11).

While remembering what Jesus did for all the people of this world, and what he suffered, I begin to think upon what we would do if we were called upon to really suffer for Christ's sake. Would we be strong enough to suffer persecution? Do we love those who hate and mistreat us? Are we praying for them? Matthew was trying to get us to examine our faith and see if we were able to stand steadfast even in death when he told us, "He that findeth his life shall lose it; and he that loseth his life for my sake shall find it."

Many are having to suffer for Christ's sake now in many places in the world. As time goes on, and conditions get worse and worse, many more will have to suffer and possibly give up their lives to stand steadfastly in the faith. In the beginning of the church, many suffered untold persecutions and some gave their lives, even burned at the stakes. In Acts the fifth chapter we find where some believers had met and talked about what they were suffering for Christ's sake, and when they left they were rejoicing that they were counted worthy to suffer for Christ's name. Is our love for Him so strong that it would be that outstanding? Is God blessing you for the way you are standing for the cause of Christ? What kind of testimony do we really have? He is waiting with Streams of His power to flood your soul and make you able to stand steadfastly and witness for His love.

CARD OF THANKS

I would like to thank each one for the many kind, thoughtful acts that all of you have done for my family and me during my long stay in the hospital. You'll never know how much it meant to me, to know how many were thinking of us. Thanks so much for all the cards, gifts, flowers, and food and also a very special thanks to Dr. Howell and the hospital staff. I miss all of you. Tammy Greenwood 4-1 tlc

BICENTENNIAL COINS NOW ON CONTACT
TRUSCOTT BICENTENNIAL COIN COM
Truscott, Texas

NOTICE OF INTENTION TO ENGAGE WEATHER MODIFICATION ACTIVITIES

NOTICE IS HEREBY GIVEN THAT IRVING P. KRICK INC. OF TEXAS, 611 S. Palm Canyon Drive, Palm Springs CA 92262, who holds License #76-2 of the State of Texas, intends to engage in an operation to change or attempt to change by artificial methods the natural development of appropriate atmospheric cloud forms or precipitation forms which occur in the troposphere, for and on behalf of WEATHER MODIFICATION INC OF THROCKMORTON, TEXAS, and will conduct a program of weather modification to increase useful precipitation by means of ground-based silver iodide dispensers, as follows:

1. Area in which equipment will be operated includes the Texas counties of Knox, Baylor, Archer, Stonewall, Haskell, Throckmorton, Young, Fisher, Jones, Shackelford, Stephens, Palo Pinto, Nolan, Taylor, Callahan, Eastland, Erath, Rannels, Coleman, Brown and Comanche.
2. The target area will be portions of the Texas counties of Throckmorton, Shackelford, Young and...

WEATHER MODIFICATION AFFAIRS
COORDINATOR
TEXAS WATER DEVELOPMENT BOARD
P.O. Box 13087 Austin, TX 78711

DATED: 23 March 1976 SIGNED: Paul J. ...



We have a new home. Come help us warm it.

On Saturday, April 3, from 9:00 a.m. to 4:00 p.m., you are cordially invited to our Grand Opening.

A large number of tiny second graders will officially open the doors at 9:00 a.m. by untying mammoth ribbon.

Over 18 prizes will be given away throughout the day by famous WBAP radio personality D. Yaws including boots, belts, signed western prints, Corvus clocks, a Mowrey gun, Thermos air pots, and savings accounts.

A Grand Prize will be given away at 3:30 p.m. for a free trip to Washington, D.C. and Colonial Williamsburg.

Be sure and bring the kids to talk with Mickey Mouse, Donald Duck and the Easter Bunny. Also you can sign a giant reproduction of the Declaration of Independence.

KSWA Radio will be on hand in the afternoon to interview guests.

A special time capsule burial ceremony will be held at 4:00 p.m. to finalize the event. Please join us for an eventful day of fun. Tour our facility. And open a savings account. 'Cause it's the Olney way to save.

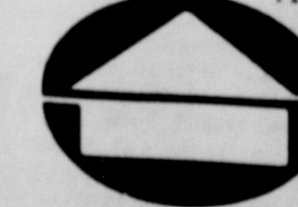

OLNEY SAVINGS
300 East Main
OLNEY, TEXAS

Second ANNIVERSARY Dinner

SUNDAY, APRIL 4

Smorgasbord

Adults - \$2.25
Children 12 under-\$1.89

ALL YOU CAN EAT

Eat All You Want
But Please Eat What You Take

Thank you for your fine patronage

KORNER KITCHEN

B.L. Bradberry - Owner

BENJAMIN NEWS

By Mrs. Van Green

sons of Knox City, Mr. and Mrs. Kenneth Benson and Mrs. Don Jennings and little granddaughter, Alicia Walsh of Wichita Falls, Tommy Benson and Lance Wilder of Midland. Also joining the family on Sunday were the Billy Bensons and the Vernon Bensons of Benjamin.

Terry Cartwright of LCC in Lubbock spent the weekend with his parents, Mr. and Mrs. W.T. Cartwright and Tracy.

Little Miss Brandi Anderson of Hamlin visited her aunt and uncle, the Fred Carvers the first of the week.

Mr. and Mrs. Van Green and Diane, Debbie Stamps and Becky of Knox City, visited their parents and grandparents, near Lake Texoma over the weekend.

Mrs. Charlie Groves visited her aunt, Mrs. Venta Horne of Gilliland in the Wichita General Hospital Sunday. Mrs. Horne suffered a broken arm in a fall in Munday on Friday.

FLBA (from page one)

rently has 35,000 loans for more than \$1,145,000,000 outstanding. The Federal Land Bank Association of Haskell makes and services loans in this area. Members of the Board of Directors are O.G. Lewis, president, E.H. Burnett, Weldon Walker, Ernest Beck Jr., Ralph Howe, and Mr. Nix.

Others attending the meeting from this area were Beck and Joe Harper, association manager.

FROM UT

Adrian Gonzales, student at the University of Texas in Austin, visited here recently during his spring break from classes with his parents, Mr. and Mrs. Celso Gonzales and Junior.

IN FORT WORTH

Mr. and Mrs. Joe Reeder visited in Fort Worth with their son, Mr. and Mrs. Joe Reeder III over the weekend.

FROM DENTON

Janie Caradine and Susan Rains of Denton visited in the home of Mr. and Mrs. Jerry Stamps over the weekend.

Truscott - Gilliland News

by JIM CUMLEY

COMMUNITY EVENTS

The Truscott Community Improvement scrapbook was turned in to the judges Friday afternoon. Mrs. Clara Brown rushed to Benjamin just a few hours before the deadline, but the scrapbook really looked great.

The members of the Gilliland Baptist Church attended the Benjamin Baptist Church Revival Sunday night.

The Truscott Home Demonstration Club met Thursday in the home of Mrs. E.J. Jones. The program was on terrariums.

AROUND TOWN

Visiting Mr. and Mrs. W.O. Corder last weekend were Mr. and Mrs. Elmo Glasscock of Dallas.

Ruth Brown visited home from college this weekend. Mr. and Mrs. W.R. Moore of Munday visited Mr. and Mrs. D.E. Burgess last week.

Guests of Mr. and Mrs. N.L. Looney Sunday were Mrs. Beverly Gray of Thalia and Mrs. Steve Gray of Vernon.

Mmes. John Jamison, Curtis Casey, Jack Brown, and Idoma Chowning attended the Retired Teachers Association meeting in Knox City last Friday. Mr. W.H. Healy of Paducah was the speaker.

Rhonda Heard spent Friday night with Betty Clower in Benjamin and both girls attended the Baptist Church Revival.

Visitors of Mr. and Mrs. Clyde Bullion this weekend were Glenna Green of Abilene, and Becky Flannigan and Sharon Flannigan, both of Tulsa.

Mr. and Mrs. Jim Shook of Wichita Falls visited the Elmo Shaw family last weekend.

Mr. and Mrs. Homer Martin, Dolph Martin, and Mrs. Gladys Meek spent the weekend in Azle with Mr. and Mrs. W.K. Dowdle and family and Darlene Meek. Sunday they honored Dolph Martin on his 87th birthday with a party.

Others present were Mr. and Mrs. Manord Fetters and children, Mr. and Mrs. Buz Closs and Steve, all of Azle, and Rose Martin, Cecil Blewins, Minnie Bell Wates, Mr.

and Mrs. Jerry Bell and Amie, all of Fort Worth, and W.K. Dowdle Jr. of Fort Hood.

Guests in the home of Mr. and Mrs. Curtis Casey Monday were Rev. and Mrs. Don Barron of Eastland.

Mrs. Walter Taylor of Farmers Valley spent last Thursday with Mrs. Guyann Hickman.

Visiting Mr. and Mrs. Paul Bullion last weekend were Mr. and Mrs. Billy Dishman of Vernon.

Mrs. W.R. Owens visited Mrs. W.O. Solomon in the Knox City rest home last week.

Visitors in the home of Mr. and Mrs. W.H. Haynie over the weekend were Mr. and Mrs. Raymond Hennan of Wichita Falls and Mr. and Mrs. Bob Haynie and girls, also of Wichita Falls.

Mrs. H.P. Gillespie is visiting her son in Ackerley.

Mrs. Bernice Davis returned home after a weeks visit in the home of Mr. and Mrs. C.E. Ellis in Abilene.

Floyd Cook of Lewisville visited Mr. and Mrs. L.G. McGuire last weekend.

Visiting Mr. and Mrs. E.D. Welch over the weekend were Mr. and Mrs. George Oustad of Earth.

Mrs. Jack Whitaker visited Mr. and Mrs. Oscar Whitaker in Tahoka this week.

Jewel Heard of Red Springs visited the Lloyd Heard family last week. Tuesday, Mr. and Mrs. Heard went to Olney and visited Mrs. Lois Enlow and James Stevens.

Visitors of Mr. and Mrs. W.H. Simmons Sunday were Mr. and Mrs. S.D. Kinnibrugh of Floydada.

FROM SNYDER

Temi Baker spent her spring break here visiting with her parents, Mr. and Mrs. Bill Baker.

Temi attends Western Texas College in Snyder.

FROM ABILENE

Gayle Tankersley visited here over the weekend with her parents, Mr. and Mrs. Samuel Tankersley.

Gayle is a student at Stenograph Institute in Abilene.

Lions Club News

By Z.I. SMITH

During their noon meeting Wednesday, the Knox City Lions were entertained by Mr. and Mrs. Jimmy Tankersley and their children, Lawrie, 6, and Boyce, 4. The group was composed of Jimmy, who sang and played electric guitar and Lawrie and Boyce, who harmonized with their dad on several numbers. President Elliston complimented the family on behalf of the entire club.

Cub Lion Wink Shiflett brought as his guest the Reverend Ray Shiflett from Henryetta, Oklahoma.

The name badge case had "mysteriously disappeared" before the members arrived and the tricky tail twister fined everyone for being "out of uniform", this situation looked awfully suspicious.

Turquoise Is Fragile

Turquoise is more fragile than diamonds, so Indian jewelry should be treated carefully.

Avoid wearing the jewelry when doing rough work that could scratch or chip the stones. Also chemicals found in some detergents and hand lotions can discolor turquoise and affect the patina of the silver.

The silver itself should not be polished with any kind of solvent. The patina would be stripped, removing the natural highlights of the silver. To clean the silver, use the jeweler's polishing cloth (for sale at jewelry stores) to remove surface tarnish.

To store jewelry, wrap the pieces in old cloths and avoid stacking the pieces. Some jewelers suggest using the Indian method for storage--place the jewelry in cornmeal and store in a dry place. The small amount of oil in the cornmeal helps maintain the luster of the stone.

FROM WESTERN TEXAS

Mel Reed returned Sunday to classes at Western Texas College in Snyder after spending the spring break here with his parents, Mr. and Mrs. Charles Reed and Kevin.

KC Colored News-Events

BY ALESTINE FLYE

I visit the First Christian Church for Sunday school and morning service this morning (Sunday) and enjoyed it so much. The teaching of Sunday school were well taught. I thought that would be the highlight of my day, but the young pastor brought such wonderful sermon, I were so happy all day, I felt so welcome and in place there. Thank you all for a wonderful time in the Lord.

Mrs. Ima Jean Session and her granddaughter and grandson of Albuquerque, New Mexico, will leave for home on Monday. After spending a few days visiting her mother, Mrs. Annie Mae Moss. While in Knox City Mrs. Session and mother visit Mrs. Session's sister and brother-in-law, Florene and Rubin Hornby of Stamford. Mrs. Session and Mrs. Moss were guests in the home of Mrs. Beatrice Mays Sunday evening.

Fred Washington of Carlsbad, New Mexico visit his mother-in-law, Mrs. Bertha Shelby Saturday. Mr. Washington visited his mother in Hamlin who is a patient at the hospital.

SERVICES OF THE CHURCH OF GOD IN CHRIST

Services were held five nights of last week at the Knox City Church.

The Knox County News

Knox City, Texas
Mrs. Billye Bess Angle
Editor and Publisher
Published at Knox City, Texas 79529, every Thursday. Second Class Postage Paid at Knox City, Texas 79529.
SUBSCRIPTION RATES
One Year in Knox and Adjoining Counties \$4.50
One Year Elsewhere in Texas \$6.00 plus 30c tax (no tax)
One Year Outside Texas \$6.50
NOTICE - Any erroneous reflection upon the character, standing, or reputation of any person, firm, or corporation, which may appear in the columns of this paper will gladly be corrected upon notice of same being brought to the attention of the publisher.

Different speakers spoke each night. Monday night Sis. Manuel spoke from Psalms 86. Tuesday night Elder Leon Ward preached from II Timothy 3:15, 16 a great message.

Wednesday night Sis. Taylor spoke from Psalms 37:1. Thursday night Elder Blue preached.

Friday night Bro. Lewis Flye spoke from Acts 11:29, 30, and another scripture. Sunshine Band was held on Saturday evening.

Sunday School had a good attendance with Ass't. Supt. Manuel in charge. In the morning service Pastor Bennett preached from Psalms 15.

The Union Joint Meeting was held at the Bethel Church in Abilene Sunday evening. Elder Menion Cox preached.

RETURN HOME

Mr. and Mrs. Bert Leaverton, Bill and Lee of Ackerly returned home Sunday afternoon after spending a week with her parents, Mr. and Mrs. John Smith. Other guests were Mr. and Mrs. Lloyd L. Davis Sr. of Ruidoso, New Mexico.

I WANT to be your next Commissioner for Precinct One, Knox County.

I FEEL that I am qualified for this important job.

I ASK for your vote and support in the May 1 Primary.

C.C. [Buddy] Angle
Pol. adv. Pd. For By
Buddy Angle, Knox City.

Dr. C.L. Cromwell
OPTOMETRIST
Phone 915 773-3542
Stamford

WALLACE MOORHOUSE INSURANCE
"Your Protection our Profession"
Insurance-Real Estate-Appraisals-Mortgage Loans
Phone (817) 422-4341 P.O. Drawer 9 Munday, Texas 76371

DRIVE-IN BANKING



Two, three or four . . . just drive right up, roll down the window and your check is cashed, deposit accepted, all in a jiffy. No standing in line and no parking worries. Be different, try it today.

CITIZENS STATE BANK
MEMBER F.D.I.C.--INSURED TO \$40,000
Knox City, Texas

Clip this coupon for a FREE one-day RETIREMENT VACATION at John Knox Village of West Texas. Exclusively for persons 55 and over.

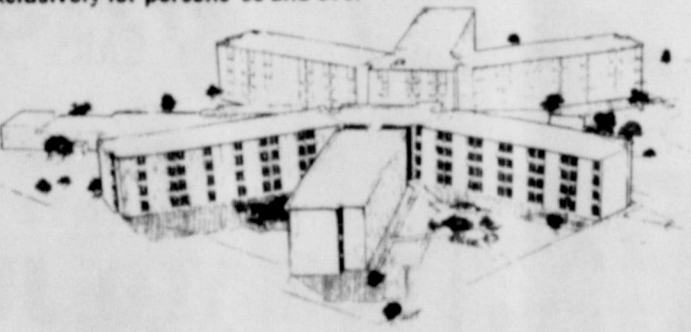

Now you can enjoy a special one-day vacation at John Knox Village . . . just so we can show you why we think you will enjoy Life-Care retirement living.

- FREE Lunch or Dinner at Skyline Inn
- FREE "AFFORDABLE RETIREMENT LIVING" by Dr. Kenneth P. Berg
- FREE Senior Power Magazine
- FREE "WORDS OF WISDOM" (Donated by The Billy Graham Evangelistic Association) in the Chapel
- FREE "THE BEST IS YET TO BE" at the Country Store
- FREE Garden Seeds at the Botanical Gardens
- FREE Beauty Gift in the Beauty Salon
- FREE Puzzle at the Game Room
- FREE Ice Cream Sundae at Ye Olde Ice Cream Shoppe
- FREE Foot Care Kit at the Med-Center
- FREE "JOHN KNOX VILLAGE COMMUNITY COOKBOOK"
- FREE Sewing Gift in the Sewing Room
- FREE Personalized Walking Tour of John Knox Village of West Texas

Please phone for reservations - (806) 797-4305
1717 Norfolk, Lubbock, Texas 79416 Tours Daily 9-6 Sundays 1-6
Offer Good Until April 30, 1976

Hair Stylist
SHIRLEY HUDGENS OF ROCHESTER
is in the
Mini-Mall at Knox City
Wednesdays, 8:30-5:30
Haircuts - Blowcuts (for men and boys)
Call 658-3957 for appointment

Dependable Quality
Plumbing Service
KNOX Central Heating
And Air Conditioning
SEE or CALL
Sheet Metal & Plumbing
Shop Phone 658-3341 Knox City, Texas

EVERYTHING AUTOMOTIVE
Gates Fan Belts, Hose, Pulleys, and Light Duty Belts for Air Conditioners
Fram and Hastings Oil Filters, Air Bath Filters
PISTON RINGS, GASKETS, and INSERTS FOR ALL MOTORS
Monroe Shock Absorbers and Load Levelers
We also carry a complete line of TRACTOR PARTS such as Pistons, Rings, Inserts, Rearings and Gaskets
OWENS AUTO SUPPLY
Central Ave. Phone 658-3323

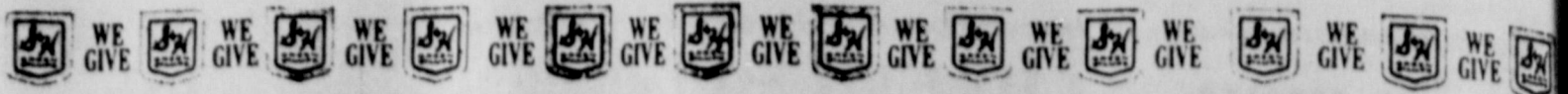

M SYSTEM

Your FRIENDLY
SUPER MARKETS
KNOX CITY

DEL MONTE

IT'S STOCK UP TIME AT "M" SYSTEM

DOUBLE S & H GREEN STAMPS WEDNESDAYS
With The Purchase Of \$2.50 Or More

SPECIALS GOOD THURS. FRI. SAT. APRIL 1-2-3

DEL MONTE GOLDEN

CORN

3 303 CANS \$1.00



DEL MONTE SPINACH

3 303 CANS \$1.00

RIGHT RESERVED TO LIMIT

DEL MONTE CUT GREEN BEANS

3 303 CANS \$1.



DEL MONTE FRUIT COCKTAIL

3 303 CANS \$1.00

KOUNTRY FRESH BUTTERMILK

HALF GAL. 69¢

KOUNTRY FRESH COTTAGE CHEESE

16 OZ. CTN 59



DEL MONTE PINEAPPLE GRAPEFRUIT JUICE DRINK

46-oz. Can 49¢



DEL MONTE-Whole New POTATOES

3 303 CANS \$1.00

KOUNTRY FRESH PEANUT BUTTER

18 oz. JAR 79

FRUIT OF THE LOOM



BUDGETEER PANTY HOSE PAIR 79¢

GLEEM TOOTH PASTE 5 oz. TUBE 79¢

HEAD & SHOULDERS SHAMPOO 7 oz. BOTTLE \$1.39

DEL MONTE TOMATO JUICE 46 oz. CAN 59¢

KOUNTRY FRESH SOFT OLEO 1-LB. TUB 49¢

NOTEBOOK FILLER PAPER 300 COUNT PKG. 79¢

MRS. BAIRD'S STRAWBERRY FRUIT ROLL 13 oz. PKG. 59

JETTON'S B-B-Q SAUCE 18 oz. BOTTLE 59

KIMBELL SALAD DRESSING FULL QUART 69



END UP SALE!



WOMEN SHOPPERS AT M SYSTEM ARE "WOMEN OF THE YEAR" - ALL YEAR LONG!

WATCH THE "WOMEN OF THE YEAR" TV SPECIAL
 GET FREE WOMEN OF THE YEAR GUIDE Thursday Night April 8
 GET ALL DETAILS ABOUT WOMEN OF THE YEAR DATE BOOK... ALL AT OUR TIDE, IVORY LIQUID, CASCADE DISPLAY

	GIANT SIZE \$1.09		GIANT SIZE 22 oz. 89¢		GIANT SIZE 35 oz. 99¢
---	-----------------------------	--	------------------------------------	---	------------------------------------

EL MONTE
ATSUP
 14-OZ. BOTTLES
FOR \$1.00

MONTE CHUNK LITE
UNA
49¢

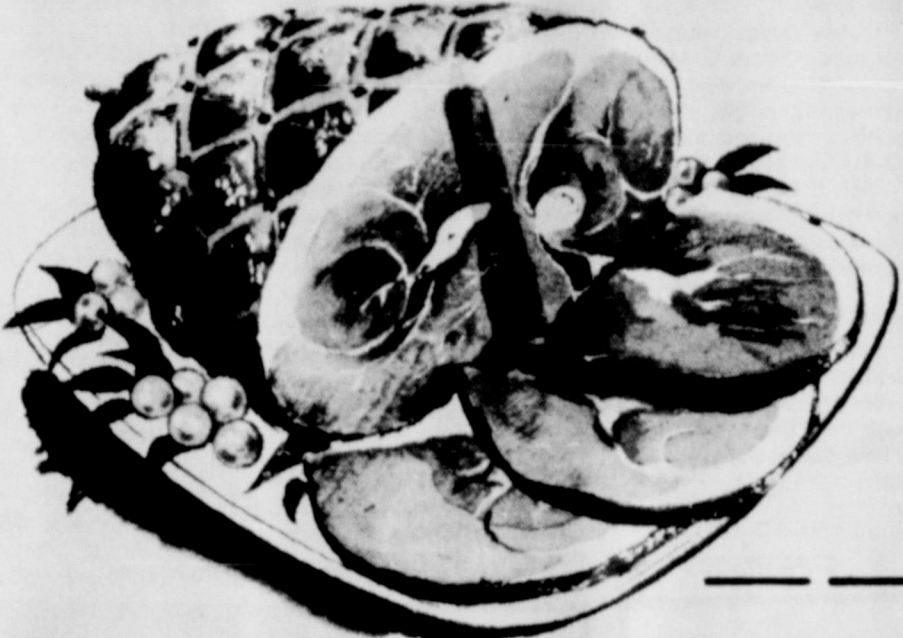

SMOKED PICNICS
 lb. **73¢**

KOUNTRY FRESH
HOMO MILK
 GALLON PLASTIC JUG (NO DEP.)
\$1.59

ARMOUR STAR
BACON
 SLICED LB. **\$1.39**



Decker's Hot Links lb. **79¢**
 Fresh Beef Liver lb. **59¢**

GREAT SELECTION
EASTER CANDIES

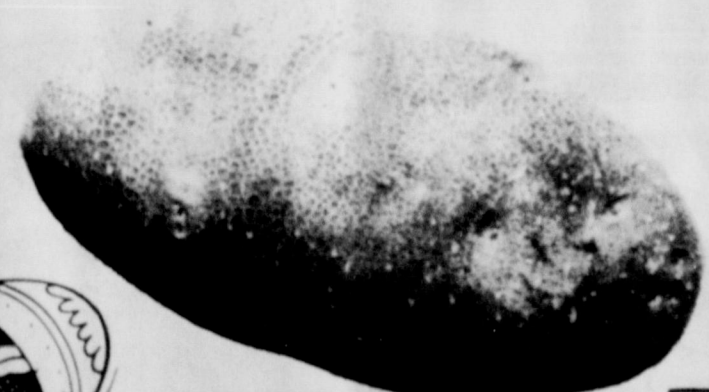

POTATOES
 ALL PURPOSE RUSSETS
 8 LB. BAG **89¢**

TEXAS SWEET Ruby Red Grapefruit 5 LB. BAG **69¢**
 Virginia RED ROME Apples EXTRA FANCY 4 lbs. **\$1.00**
 ICEBERG LETTUCE 3 HEADS FOR **\$1.00**
 K-Y Green Beans 3 lbs. **\$1.00**



CANTALOUPES
 VINE RIPE SUGAR SWEET EACH **49¢**

LIPTON INSTANT TEA
 3 OZ. JAR **\$1.39**

WE GIVE  WE GIVE  WE GIVE  WE GIVE  WE GIVE  WE GIVE  WE GIVE  WE GIVE  WE GIVE  WE GIVE  WE GIVE  WE GIVE  WE GIVE  WE GIVE  WE GIVE  WE GIVE  WE GIVE  WE GIVE  WE GIVE  WE GIVE  WE GIVE  WE GIVE  WE GIVE  WE GIVE  WE GIVE  WE GIVE  WE GIVE  WE GIVE  WE GIVE  WE GIVE  WE GIVE  WE GIVE  WE GIVE  WE GIVE  WE GIVE  WE GIVE  WE GIVE 

WE GIVE  WE GIVE  WE GIVE  WE GIVE  WE GIVE  WE GIVE  WE GIVE  WE GIVE  WE GIVE  WE GIVE  WE GIVE  WE GIVE  WE GIVE  WE GIVE  WE GIVE  WE GIVE  WE GIVE 

O'Brien Happenings

CHARLENE BROTHERS

The students at O'Brien school are getting in the groove of being active again with track, tennis and UIL contests coming up next month.

Devy Holmes, David Adkisson, David Walling and Louis Rojas, along with Coach Charles Reed, were in Olney last Saturday for a track meet. Devy won first in pole vault and 100 yard dash and second in 220; David Adkisson placed fourth in pole vault and sixth in 440; David Walling won fifth in high jump, and Louis placed sixth in the shot put. These boys won fourth in the meet.

The High School District Tennis meet will be held at Hardin-Simmons University in Abilene on April 7. Entering in the boys' doubles are Domingo Garcia and David Adkisson and Joe Gutierrez and Max Rocha, with Gary Jackson and Louis Rojas as alternates. In the singles are Craig Brothers, John Alsides, with David Walling as alternate. In the girls' division singles entered are Betty Gutierrez and Donna Holmes, and doubles are Debbie Del Hierro and Peggy Gutierrez with Donna Holmes as alternate.

The Literary Meet of UIL will also be held at Hardin-Simmons University at Abilene on April 9. We will have a list of the contestants in this next week.

HERE AND THERE

Visiting in the home of Mr. and Mrs. Ed Whiteley recently was their daughter, Mrs. Tim McBroom of San Angelo, Paula was on her spring break from college.

Mr. and Mrs. Jerry Rowan of Henrietta, Mr. and Mrs. Lowell Rowan, Paul and David of Denton, Mr. and Mrs. Trey Burson and Traci of Haskell visited in the home of Mrs. Bernice Rowan during the weekend.

Visiting in the home of Mr. and Mrs. Sam Johnson during the weekend were Mr. and Mrs. Kenneth Roberts and boys from Plainview and Mr. and Mrs. James Duncan, Becky and Karla of Lubbock. The Duncans also visited with his parents, Mr. and Mrs. Clifton Duncan.

Visiting in the home of Mr. and Mrs. Ranzy Herring were Mr. and Mrs. Adeler Herring, Ken and Alan of Junction. Also visiting with them Sunday afternoon were Mr. and Mrs. Alvin Hines, Andy and Julie of Munday and Mr. and Mrs. J.O. Brothers of O'Brien.

Serena Johnston returned to her home after spending nearly two weeks in Lubbock with her daughter and husband, Mr. and Mrs. Sonny Hughes.

Visiting in the home of Mr. Ernest O'Neal during the weekend were Mr. and Mrs. Bobby O'Neal, Traci and Scott of Lubbock. They also visited with her parents, Mr. and Mrs. Virgil Mitchell in Rochester.

Mr. and Mrs. James Manning and Cody visited in

Extension Plans To Be Made

The overall Knox County Program Building Committee will meet on Thursday, April 1, at 7:30 p.m. in the First United Methodist Church Fellowship Hall at Munday.

Each subcommittee of the overall Program Building Committee will be represented, according to county Extension agents Nancy Fuhrken and Herman Collier. A covered dish supper is planned with committee members bringing a dish other than meat.

The purpose of the meeting will be to develop program ideas for the 1976-77 Extension Plans of Work. Each committee considers programs which will meet the needs of most of the persons in the county in a specific subject area.

Anyone having suggestions for programs may contact the County Extension Agents at 454-2651 at Benjamin before the meeting.

Educational programs conducted by the Texas Agricultural Extension Service serve all people of all ages regardless of socio-economic levels, race, color, sex, religion, or national origin.

Haskell, Paducah Win Meet

Haskell's boys and Paducah's girls edged out some 43 teams to take first place honors in their respective divisions in Knox City's annual Junior High Track Meet held here last Thursday at Greyhound Stadium.

Placing for Knox City's boys who won third place were: chinning, Rickey Gonzales, first, 30 and Danny Rios, fourth, 22; shot put, Tim Roberson, sixth, 37'7"; 440 relay, Danny Rios, Rickey Gonzales, Greg Elston and Tim Roberson, fifth, 51.2; 660 yard dash, Junior Figueroa, third (no time given); 330 yard dash, Dwayne Johnson, third, 42.7 and Greg Elston, fifth, 43.1; 60 yard high hurdles, Greg Whitten, third, 9.8; 220 low hurdles, Greg Whitten, second, 29.7 and Dwayne Johnson, fourth, 30.2; and 1320 relay, Dwayne Johnson, Greg Whitten, Rickey Gonzales, Tim Roberson, fourth, (no time given).

KC's girls tied for tenth place in the meet. Scoring for Knox City were Stacy Leach who was fifth in discus with a throw of 68'11"; Mindy Hutchinson, fifth in the hurdles with a time of 13.6; and the 1320 relay team of Gerri Watson, Kim Rhodes, Angie Bateman, and Mindy Hutchinson placed with a time of 3:23.8.

Following Haskell in the boys' division was Quannah with 75 points for second; Knox City, 68, third; Munday 63, fourth; Rule 46 1/2, fifth; and Anson, 38 1/2, sixth.

Munday's girls followed behind Paducah for second place with a total of 70 points. Haskell finished third with 63, Quannah had 50 for fourth, and Hamlin and Windthorst had 48 and 46 to finish fifth and sixth, respectively.

Hospital News

PATIENTS IN HOSPITAL MARCH 27, 1976

Knox City: Carrie Dunnam, Lois P. Buckley, Elmer Scott Munday; Louise Nance, J.M. Smith, L.C. Vance
Goree: Barton Carl
Rochester: Ocey Jenkins
Benjamin: Myrtie Propps

PATIENTS DISMISSED SINCE MARCH 20, 1976

Knox City: Roy Montgomery, Laverne Hewitt, Pauline Hernandez, Bobbie Bradberry, Paula Lorenz and baby, Mattie Partridge, O.A. Green, Marie Shields, Bill Magee (deceased), Judy Tankersley, G.W. Coats
Munday: Elaine Michels, Zerna Brown, Eula Parks, Bruce Pruitt, Mamye Brazell
O'Brien: Robert M. Johnston, Edmund Casillas III
Goree: Josefine Garcia and baby, Aurora Castorena and baby, Gladys Roberts
Vera: Irene Allen
Throckmorton: R.H. Condron
Odessa: Robert Berryman
Rochester: Cleve Hester

FROM MCMURRY

Diane Clonts, student at McMurry College in Abilene, visited here last week during her spring break with her parents, Mr. and Mrs. Joe Clonts and Mark.

Also visiting in the Clonts home was Burton Balsh of Odessa, who attends McMurry also.

IN LUBBOCK

Mr. and Mrs. Doug Meizer and Tyke were in Lubbock over the weekend visiting with their daughter and her husband, Mr. and Mrs. Floyd Baker.

READ THE CLASSIFIEDS

TOWER DRIVE-IN
RULE, TEXAS
Fri. Sat. April 2-3
"Sky Riders"
PG
Sun. Mon. April 4-5
"Sunday School Teachers"
Rated R

It's Your Home ... Protect It
Baker-Clonts Insurance
658-3623

EVERYTHING IN IRRIGATION SUPPLIES
HESTER IRRIGATION
East Main ALTON HESTER 658-3918

TWO WAYS TO HAUL WATER

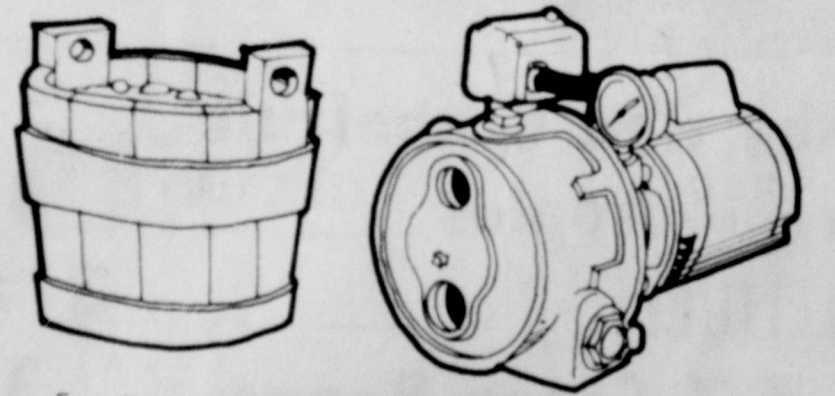

For dependability, it's hard to beat the one on the left. But, if you want dependability AND more than one bucket of water at a time, the one on the right is the perfect choice.

It's a Jacuzzi RM2, and it comes with an exclusive screw-in injector, Lexan diffuser, forged brass impeller, corrosion treated surface and a guarantee.

When you need a dependable way to haul water, visit:

LYNN ELECTRIC MOTOR CO., INC.

KNOX CITY, TEXAS 79529
658-3511

NOBODY BACKS YOU BETTER

News Notes from the Brazos Valley Care Home

by MRS. EDNA EUBANK

Mrs. Griffith was very happy to see her son, Donnie of Austin.

Mrs. Williamson spent Sunday at her son, Clifford Her granddaughter, husband and girls were there. The out-of-towners were Mr. and Mrs. Jack Thurwhanger of Austin.

Mrs. Martha McKinney had her daughter, Mrs. Clark of Olney to see her.

Clyde and Theona Ray of Irving came to visit his mother, Mrs. Ray.

Mr. Buchanan was pleased to see the K.E. White family of Lubbock.

Mrs. Solomon's two daughters were here to see their mother. They are Mrs. Short of Oklahoma City, Oklahoma, and Mrs. Lloyd of San Angelo.

Connie Ziegler, husband and boys paid her grandmother, Mrs. Martha McKinney, a visit.

Mrs. Margaret Posey from Gordon and Mrs. Kathleen Posey of Knox City visited Mrs. Ballard.

Mr. and Mrs. Emond Short called on Mr. Waldrip.

Mrs. Gertrude Weatherly of Socorro, New Mexico was here visiting her dad, Mr. Roberts and her sister, Margaret Alsop.

Bill Aldridge entertained Martha Miller of Merkel and niece Wanda Jerry and Gary Anderson of Big Spring.

Mrs. Wood and Mrs. Strickland of Munday visited Cliff Elliott.

Mr. Roberts celebrated his birthday on Sunday. He spent the day at the Alsups.

Mrs. Judge Parker visited

Mrs. King, Oliver King, his wife and daughter, Misti, also came to see her.

Frank and Hazel Griffith of Olney came to see his mother, Mrs. Griffith.

Miss Scifres enjoyed visits from two of her brothers from Rule.

Norman and Irene Lusk of Abilene visited Mrs. Beasley. Jim Burleson's brother-in-law, Jack Owens of Fort Worth, paid him a visit.

Mrs. Canaday's granddaughter took her out to Audrey's for the day on Thursday.

We have a new tenant, Mrs. Mattie Hodges of Arlington. Mrs. Hodges is a long time resident of Knox City.

Debra Piasle, Mr. Burleson's niece, was here to see him. She is from Rochester.

Mr. Buchanan's granddaughter of Jacksonville, Florida was here to see him. Cathy Hughes was accompanied by her other grandfather, Dennis Hughes of Midland.

Mr. and Mrs. Owens of Truscott were welcomed by Mrs. Solomon.

FROM H-SU

Annette Jackson, freshman student at Hardin-Simmons University in Abilene, spent spring break last week visiting in the home of her parents, Mr. and Mrs. James Jackson, Sherry and Skipper.

FROM UVALDE

Mr. and Mrs. Brack Shaver and Braxton of Uvalde visited here recently in the home of his parents, Mr. and Mrs. Eddie Shaver.

Girls Place Sixth At Burk

Knox City High School's track girls won sixth place last Friday at Burkburnett with a total of four wins.

Jewell Culberson won the only first for the KC team with her throw in the discus competition of 98'10".

Three fifth places were also won by KC including Beverly Ward in the 220 yard dash with a time of 27.4 and also in the 100 yard dash with an 11.9. Finishing out Knox City's wins was the 440 relay team of Sheryll Guinn, Gayle Ware, Cynthia Rhodes, and Beverly Ward. No time was available on this race.

The girls will compete Friday in the Jayton track meet.

Mrs. Tankersley Is Shower Honoree

Mrs. Jimmy Tankersley was honored with a baby shower Saturday night at 7:00 o'clock in the home of Mrs. C.H. Cornett.

Games were played prior to the honoree's gift opening.

Refreshments of punch and cookies were served to the twenty-one guests who called.

Hostesses included Gail Etheredge, Sandy Bradley, Cathy Richardson, and Sandra Chambers.

YOU are welcome First United Methodist Church

SUNDAY SCHOOL
MORNING WORSHIP
SUNDAY EVENING SERVICE

Photography by Susan
Central Texas Finest Photography
Specializing in Outdoor Portraits
will be in
KNOX CITY
WEDNESDAY, APRIL 14
Appointment Only
Call Knox City's Mini Mall
658-3957
Limited number of appointments available so don't wait
Small display now at Mini Mall

2 for 1 Dairy Queen Sundae Sale

Buy One, Get One free!

Wow! Now's the time to buy a delicious "Dairy Queen" Sundae. Buy any flavor, any size Sundae and you get another one the same size, absolutely free!

Bring a friend and hurry down to "Dairy Queen". The 2 for 1 Sundae Sale starts this Tuesday and ends Sunday. Only at participating stores.

March 30th thru April 4th only.

Dairy Queen

PFI President To Address Local Lions

Bud Nevin, president of Physical Fitness Institute, Inc., Midwest Region, will speak to the Knox City Lions on April 7 at 12:00 noon in the Masonic Lodge. Nevin's topic will be "How to Remain in Business and Stay Alive."

PFI, headquartered in Peoria, Illinois, was organized in 1972 by its director, Perot Nevin, Jr., a California educator and life-long physical fitness advocate. The goal of the Institute is to attack the source of what many authorities feel to be the major contributing factor to many of the health problems afflicting modern society—the lack of physical fitness in the "average individual and family."

Many of the Nation's serious illnesses," says Nevin, "can be directly or indirectly traced to the poor physical condition of the sufferers...especially in the areas of heart disease, stroke, high blood pressure, chronic back problems and obesity. Medical authorities are also now telling us that many mental illnesses and the inability to cope with the stresses of modern living have a relationship to poor physical condition."

In addition it works with those whose vocation requires them to be physically fit. It has implemented the training programs of the NFL's Minnesota Vikings, the Oakland Raiders, the NHL's Philadelphia Flyers, the NBA's Golden State Warriors, plus several national amateur teams and individual athletes in various sports.

PFI bases the majority of its programs on a relatively new exercise concept called "Total Isokinetics". The concept is currently undergoing considerable research and study by the physiology departments of the University of Arkansas, Texas State Women's College and Northern Illinois University. PFI is funding many of these projects.

As a president for Physical Fitness Institute, Nevin's job is to implement the Institute's program within the Midwest and Texas. Nevin lives in Hughes Springs, Texas.

IN JOURDANTON

Mrs. M.S. Lowrey is spending this week in Jourdanton where she is visiting her brother, Buck Howell, who suffered a stroke about three weeks ago. According to reports, Buck is improving and doing well.

He and his wife, Velma, former Knox City residents, lived for a number of years in Brownfield before moving to Jourdanton to be near their daughter and her husband, Mr. and Mrs. Ron Jenkins. The Jenkins spent Sunday night here with Mrs. Lowrey and she accompanied them to Jourdanton Monday. Mrs. Lowrey's daughter and her husband, Mr. and Mrs. Charles Reed, will go after her this weekend.

CALL IN YOUR NEWS
658-3142

THRIFTY OFFICE EQUIPMENT
COMPLETE SALES & SERVICE
P.O. Box 1828
Vernon, Texas
For local service, call 658-3142
or leave machine at
The Knox County News



No segment of the economy has ever changed so fast and so completely as has agriculture during the past 60 years. When these changes have required capital, your Federal Land Bank has been a primary source of funds. There will be more changes. But we believe that a free agriculture—based on the family-operated farm or ranch—will continue to flourish in any new environment.

FEDERAL LAND BANK
ASSOCIATION OF HASKELL



We are banking on the farm family and on the family farm.

JOE HARPER, Manager

Offices at Haskell, Anson, and Seymour
HASKELL TELEPHONE 864-2062
ANSON TELEPHONE 823-1142
Long-time loans on farms and ranches in Haskell, Jones, Baylor and Knox Counties.

Seniors Of The Week

And Their Autobiographies



MARK HOWELL

John Mark Howell was born November 23, 1957 in Dallas to Dr. and Mrs. R.G. Howell. Two years later Mark's brother, Mike, was born. The family then moved to Miami, Florida for two years, then to Big Spring, Texas where Kay was born. The family finally ended up in Knox City when Mark was about six years old.

Mark began formal schooling in 1964 in the Knox City Schools. He survived his first eight years of schooling with nothing worse than a broken leg. Mark participated in football, basketball, and track while in Junior High.

While in high school, Mark served as a class officer for three years; was in FFA, three years; football, four years; basketball, three years; golf, four years; and FTA, two years. He was active on the Annual Staff for four years, his senior year being co-editor.

Mark is a member of the First United Methodist Church in Knox City.

After graduation, Mark plans to attend Baylor University and begin his study of medicine.

Annual Sales To Begin Monday

Annual sales for the 1976 Greyhound will begin Monday, April 5 and continue through Friday, April 9, according to Mrs. Dottie Lowrey, annual sponsor. Plain annuals will sell for \$6.30 and personalized ones will be priced at \$7.30, she said.

Anyone wishing to purchase a yearbook is asked to call Mrs. Lowrey at the school or contact any annual staff member.



MELINDA HEWITT

Melinda Beth Hewitt was born on December 15, 1957 in the Knox County Hospital. She was welcomed by her parents, Mr. and Mrs. James Hewitt and three older brothers.

Melinda attended her first three years of school in O'Brien and she continued her education in Knox City in the fourth grade.

While in Junior High, Melinda was a cheerleader her seventh grade year and then a twirler her eighth grade year.

In high school, she has been active in athletics three years; FTA, three years; FHA, four years; Annual Staff, three years; and Band, four years where she has served as a twirler for three years.

Her sophomore year, Melinda was elected secretary for the Sophomore Class and was also chosen runner-up for class favorite her sophomore year.

During her junior year, she was chosen as FFA Sweetheart for the local chapter and also was crowned as the District FFA Sweetheart.

The summer after Melinda's junior year, she was honored by being selected "Miss Spirit of '76" as part of Knox City's Bicentennial celebration.

Her senior year, Melinda is serving as typist for the FHA chapter, secretary for the band, and typist for FTA.

She is a member of the First Baptist Church. Melinda's plans for the future are undecided.

IN CISCO

Mr. and Mrs. Neal Logan were in Cisco Sunday to visit with her sister and her husband, Mr. and Mrs. R.L. Clinton.

Olney Savings Grand Opening Set April 3

On Saturday, April 3, Grand Opening ceremonies will officially open the newly constructed home office building of OLS. Special events and activities have been planned for the day-long event. A variety of prizes will be given away, plus a drawing will be held for a Grand Prize trip for two to Washington, D.C. and Colonial Williamsburg.

"The Grand Opening will be a community event for Olney," said president Don McClatchy. "We are very proud of our new building because it will bring better and more efficient service to the Olney Savings customer," he continued. "We want everyone to join in the celebration!"

The festivities will begin at 9:00 a.m. and conclude at 4:00 p.m. Numerous dignitaries will be on hand to witness the ribbon pulling event opening the front doors at 9:00 a.m. Sixty-nine second graders, the same group that broke ground for the new building in May will untie the huge ribbon to officially open the doors.

Mickey Mouse, Donald Duck and the Easter Bunny will be on hand to give away balloons and talk with the children.

KSWA will be on hand to

give a remote broadcast, interviewing spectators and guests as they enjoy the events.

Once inside the building, guests will register for prizes to be given away during the day. Free momentos will be handed out, and guests will have the opportunity to sign a giant Declaration of Independence, made especially for the opening ceremonies.

Prizes to be given away include a Mowrey gun, art prints, boots, clocks, air pots, belts, and children's pass-book savings accounts. Drawings will be held at 10:30 and

then every 30 minutes starting at 12:30. The Grand Prize winner will be drawn at 3:30.

As the final event, a time capsule will be buried near to the new building. It will be unearched and opened in the year 2,000! The capsule will contain a clock, a tabloid, a Cream of Puzzle, the Declaration of Independence and newspapers of the day.

"This is an occasion no one will want to miss," stated McClatchy. "The events have been centered around every member of the family, because everyone is important to Olney Savings."

MELON CRUSH?

It's not a new soft drink.

It's one of the new 1440 Paint Colors Available at

Knox Builders Supply

Interior Paint [White]

\$4.95

(colors slightly higher)

Exterior Paint

\$7.95

658-3416

Knox City



THE RETURN OF T.L.C.

(Tender Loving Care)

These days this special ingredient is getting harder and harder to find. Everyone seems to be in too big a hurry or too busy to really care. Not so at our pharmacy. We know that you have entrusted us with your better health when you bring a prescription to us.

T.L.C. is an important part of every prescription we fill. You can depend upon us to take the same care for you as we do for our own self and family.

"A GREAT MANY PEOPLE ENTRUST US with their prescriptions, health needs and other pharmacy products. We consider this trust a privilege and a duty. May we be your personal family pharmacy?"

H-M JONES PHARMACY INC.
PHONE 658-3215 KNOX CITY, TEXAS

Lowrey's



Color Coordinated
Pants and Tops

in Green, Yellow, Blue, Coral, White

Solid Color

Pants \$15.00

Solid or Striped

Shells \$7.50-13.50



COMMUNITY DANCING SUNDAY APRIL 4 4:00 p.m. SQUARE CHURCH

have received a new shipment of material
US A TRY - ALL WORK GUARANTEED
CHARLIE'S PHOLSTERY

Home Phone 888-3146
VERA, TEXAS 887

ANNOUNCING
AREA PUMP CO.

of Haskell

may be reached
-24 hours a day-
locally by calling

HESTER IRRIGATION
658-3918

\$UPER \$AVE MARKETS

SPRINGTIME BRINGS



FOOD SAVINGS



WHITE SWAN
FABRIC SOFTENER GALLON **79¢**

WHITE SWAN
BLEACH HALF GAL. **45¢**



Regular
or
Diet



7 UP

**Center Cut
CHUCK ROAST**

FAVOR \$ **1.09**
FURNITURE POLISH 12 oz. can



6 12 OZ. CANS **98¢**

BACON Ranch Brand Sliced Pound \$

FRANKS Wilson's 12 oz. pkg. 6

GROUND BEEF Pound 8

Ham Slices Peyton's Dry Cured Pound 9

HAMS Peytons Picnic Pound 6

Food Stamps
Welcome



Assi. FLAVORS
JELL-O
3 FOR **69¢**

BIG SAVINGS

Snickers Milky Way
3 Musketeers

CANDY BARS

6 FOR **65¢**
Reg. 15¢

SOFT 'N LITE
FLOUR
2.98
25-Lb. Bag

HUNT'S
PEARS
3 300 for **\$1.00**

ZEE
BATHROOM TISSUE
79¢ 4-BOLL PACKS



ICE MILK
99¢
1/2 GAL.



TEXSUN
ORANGE JUICE 4 6-Oz Cans \$

Keith Frozen
FRENCH FRIES 4

SHORTENING
CRISCO \$ **1.29**
3-Lb. Can



PLEASINGLY
PRICED

TREET
LUNCHEON
MEAT
98¢
12 OZ.



Chef's Best
Oleo
45¢ 1 lb. qtrs.

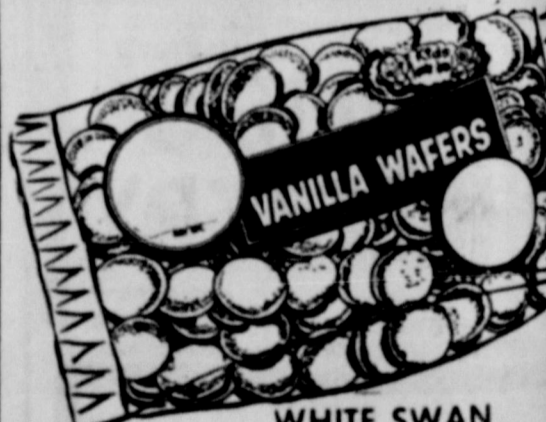

WHITE SWAN
Vanilla Wafers

12 oz. **39¢**

Prices Good Through Sat. April 3

I. G.
MILK 1 GAL. **\$1.59**

SPECIALS!

RUSSET
POTATOES 10-Lb. Bag **99¢**

WHITE
ONIONS Pound **19¢**

CALIFORNIA
LETTUCE Each **29¢**



KOOL-AID
3 FOR **29¢**
ASSORTED FLAVORS



BOB'S \$UPER \$AVE