

If a check appears by your address label, your subscription has expired. Subscriptions rates for Donley County are \$13.00. Out-of-county rates are \$16.00. Mail to: Box 1110, Clarendon, Texas 79226.

The Clarendon Press

Serving Clarendon, Hedley, Howardwick and all of Donley County.

Dedicated to Fair and Impartial Reporting

USPS 947040

Thursday, March 16, 1989

Number 11



Kimberly Altman

Donley County Spelling Bee Champion

Kimberly Altman, fourteen year old daughter of Mr. and Mrs. Stanley Altman of Clarendon, has earned the 1989 Donley County Spelling Bee Champion title by spelling down twenty-one other junior high spellers in a contest held March 8, 1989.

Kimberly is an eighth grader at Clarendon Junior High School where she is active in basketball, track, tennis, and band. She is a member of the U.I.L. Science team. In her spare time Kimberly enjoys playing basketball and playing the piano.

Kimberly will compete in the 41st Regional Spelling Bee sponsored by the Amarillo Globe-News on April 15, 1989. She will compete with forty-five other county champions from Texas, New Mexico, and Oklahoma for the right to represent this region at the National Spelling Bee to be held in Washington D. C., during the week of May 28.

Monty Jo Adams was runner up in the County Bee. He is the twelve year old son of Mr. and Mrs. Monty W. Adams of Clarendon.

Also participating were Jacob Smith, the Donley County Junior Champion, and the following students: Deana Nazworth, Lisa Hill, Stacey Alexander, Greg Collins, Kelby Leffew, Steven Davis, Tessa Fletcher, Chris McKinney, Brice Fletcher, Kelli Keown, David Lane, Jason Ward, Claire Boston, Bobbie Havens, Clay Wright, Chester Moore, Jared Sims, Janice Wilson, And Christina Guinn.

Attention Colt Mothers

We will be having a meeting on Thursday, March 16, 1989 at 5:30 p.m. in the school cafeteria. We will be planning the Colt Sports Banquet. We need your support and ideas. Please be there!

Donley County Junior Spelling Bee

Jacob Smith won the 1989 Donley County Junior Spelling Bee on Wednesday, March 8, in a contest held at Clarendon Junior High School. Jacob is the twelve year old son of Mr. and Mrs. Lige Smith of Clarendon.

Jacob is a fifth grader in Clarendon Elementary School. He lists his favorite activities as playing basketball, playing the piano, and riding bicycles. Jacob is in the band and is a member of the U.I.L. Number Sense team.

Jacob will be honored at a luncheon held during the Regional Bee on April 15, 1989.

Heidi Clennan was runner-up in the Junior Bee. She is the twelve year old daughter of Debra Clennan of Clarendon.

The following students also participated in the Junior Bee: Bili Hamilton, Tony Maxfield, Jason Morrow, Carye Adkins, Julie Altman, Randy Haire, Michael McKinney, Mandy Floyd, Jason Dunn, Jason Lee, Josh Shields, Evan Williams, Clint Green, Tamra Williams, Mandy McAnear, Christy Bird, Lewis Ellerbrook, La Tasha Butler, La Shonda Smith, Destiny Bond, Tiffany Calloway, and Logan Mays.



Jacob Smith

Donley Co. Hospital to Hold Elections

On Saturday, May 6th, an election will be held for Places 1, 2, and 3 on the Board of Directors of the Donley county Hospital District. At the present time Place 1 is held by E.W. Barbee, Place 2 is held by Lawrence Whitehead, and Place 3 is held by Dikki Howell. Anyone interested in running for any of these positions is encouraged to come by the Business Office of the Medical Center or call Larry White at 874-3760. The deadline for filing to run is March 22nd.

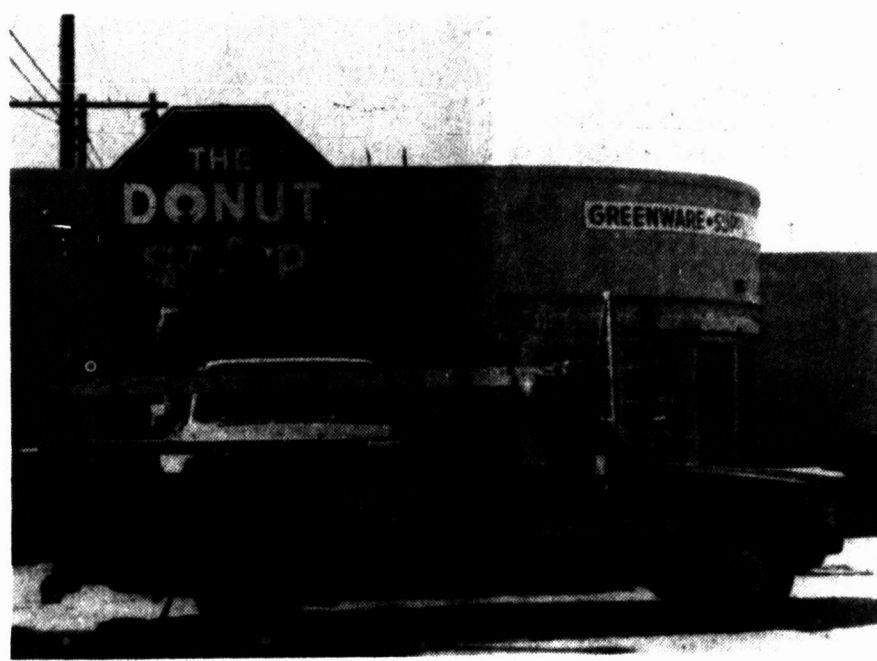

The Donut Stop is scheduled to open 6 a.m. Thursday, March 16th. The new business is located behind Bivens Pharmacy.

K-9 Korp Competes in Top of Texas Fun Match

Members of the 4-H-K-9 Korp traveled to Pampa on Sunday and competed in the Top of Texas Fun Match.

Everyone did a great job and were winners! Here are the results: Elizabeth McAnear too 1st place in the Breed ring with her yellow Labrador "jj." and 3rd in the Sporting Group. She also placed 2nd in Open Jr. Showmanship. In obedience she placed 4th in Sub-novice and Novice with her black Labrador, "Lady" Elizabeth was tied in both classes and won both run offs. Congratulations!

Misty Longan also did great. She took Best of Breed with her long haired Dachshund "Low Boy" and 1st place in the Hound Group. With her Samoyed "Roller" she took 1st in the Breed Ring and 3rd in the Working Group. Misty also took 1st place in Sr. Showmanship. Way to go! In obedience she qualified with "Low Boy" in Sub-novice and did a great job with "Roller" in Novice. Congratulations!

Samantha Mincey took her LhasaApsos "Wilbur" and it was

their first dog show. They both were very nervous but did a great job. "Wilbur" placed 1st in the Breed Ring and 2nd in the Non-sporting Group. He also did a good job in Sub-novice. Keep up the good work, Samantha.

Logan Mays took his Doberman Pincher "Dixie" and did a great job. He placed 2nd in the Breed Ring and 2nd in Jr. Showmanship. Logan and "Dixie" also worked hard and did a good job in Sub-novice obedience. Keep up the good work, Logan.

Clarendon should be very proud of these kids. If you see them, pat them on the back! They all deserve it.

Friends Of The Library Meeting Set

The Friends of the Library will meet on Wednesday, March 22 at noon in the City Library. Anyone who is interested in helping us support the library and its programs is welcome to attend.

We will be discussing plans for the upcoming used Book Sale held annually at the library. Used books are already being offered for sale at the library. Later in the Spring, these books will be sold in a sidewalk sale. We appreciate our library and the community's support.



Jimmy Thompson, Donley County Sheriff, speaking to a town meeting of parents and concerned citizens about a recreation center for local young people.

Gina Spier Participates In Internship

Gina Spier, a senior Fashion Merchandising major at Tarleton State University, is participating in a Home Economics Internship. Gina, the daughter of Mr. and Mrs. Billy Spier of Clarendon, is completing the internship in partial fulfillment of a Bachelor of Science degree in Home Economics.

Gina is working for the Lookin' Glass Inc. in Stephenville, a shop owned by Mrs. Barbara Terrell.

Assistant Professor of Home Economics Rosemary Scott organizes and oversees the program which provides the students with first-hand knowledge of the careers they will be entering. Students are required to complete a 200 hour

work period over eight weeks. The internships begin in February and continue through mid-April. The experience gives the students the opportunity to learn the challenges and successes of professionals in the marketing and retail fields.

Gina plans to graduate from Tarleton in August.

Track Teams in Wellington Meet

The Clarendon Varsity, J.V. and Junior High Colts teams will travel to Wellington, Friday, March 17th and Saturday March 18th to participate in their track meet. All parents are encouraged to attend this meet and support their children. They need your support.

Senior Citizens Dance

Senior Citizens 3rd Tuesday Dance on March 21, 1989 from 8 to 11 p.m. at the Clarendon Community Building on North Ayers Street. Music by Melvin Srygley and the Offbeats. Admission \$2.00 per person.

WTU Microwave School 1989

West Texas Utility Company will be having a Spring Microwave School Thursday, March 23 from 12 noon to 1:00 p.m. at WTU local office.

The microwave oven has become a marvelous addition to today's kitchen. Many foods cook great in the microwave oven, and it is convenient for melting ingredients, defrosting frozen foods, and warming items. During the microwave school, Jymann Hokanson, Electric Living Consultant for WTU, will demonstrate the latest in microwave cooking techniques and microwave ovens available.

Everyone is invited to come join the fun under the "Big Top". Admittance is free to the public.

K-9 Korp to Host Volleyball Tournament

The Donley County 4-H K-9 Korp will host a volleyball tournament for men and women on April 13, 14, & 15.

To enter or for more information call Melinda McAnear at 2377.

Kings Kids Present Easter Program

The Kings Kids from First United Methodist Church in Clarendon will be presenting an Easter program entitled "The Beginning to the Beginning" on Palm Sunday, March 19 at 11:00 a.m.

Kimberly Altman will be portraying Mary and Charlie Smith will play Jesus. The Angels will be Kimberley Stavenhagen, Julie Altman, Haley Hamilton and Mandy Floyd. The pianist will be Gayla Davidson and the Director is Jamie Deyhle.

The Kings Kids are Audra Kirkland, Lindsay Green, Debi Hall, Blake Deyhle, Leia Kate Deyhle, Missie Butts, Zackary Butts, Scott Bivens, B. J. Hamilton, Margaret McNabb, Madison McNabb, Liza Tull, Megan Thomson, Kara Thomson, Jacob Burkhalter,

Cont'd On P. 2



Miss Twanna Garland Wins Runner-Up in Miss Texas Tech Pageant

Twanna Garland was nominated by the Block and Bridle Club of Texas Tech University to participate in the Miss Texas Tech Pageant in Lubbock. The contest was held March 11, 1989 and Twanna was chosen as one of the top five finalists. They were judged on personal interviews, dancing, swim wear competition, and formal wear. Each of the five finalists were given a final pop question, which determined the winner.

We extend our congratulations to Twanna for being the 4th Runner-up in the Texas Tech Pageant. She was awarded a Texas Tech Pendant, a membership to the Lubbock Athletic Club, and various gifts certificates from different businesses.

Twanna graduated from Clarendon High School in 1988 and was Miss Donley County in 1988. She is the daughter of Mr. & Mrs. Jimmy Garland, and granddaughter of Mr. & Mrs. A. J. Garland of Clarendon. She is also the granddaughter of Lucile Burnett of Memphis.

Friendship Club To Meet

Howardwick Friendship Club will meet in City Hall at 6:30 p.m. on Friday, March 17, 1989.

Come help us celebrate St. Patrick's Day with Irish Music by Dee Williams and Creed Smith, following our usual covered Dish Supper.



Tammy Hommel, Ann Hommel, Mayor David Davidson, Sumer Harper, Chamber Secretary Gayla Fletcher, and Tina Dilman cut a ribbon opening the Pat Walker Figure Perfection Salon.

Weather

Day	Date	Temp	Precip
Monday	6th	lo	11
		hi	35
Tuesday	7th	lo	12
		hi	49
Wednesday	8th	lo	20
		hi	60
Thursday	9th	lo	30
		hi	73
Friday	10th	lo	44
		hi	82
Saturday	11th	lo	48
		hi	92
Sunday	12th	lo	52
		hi	98

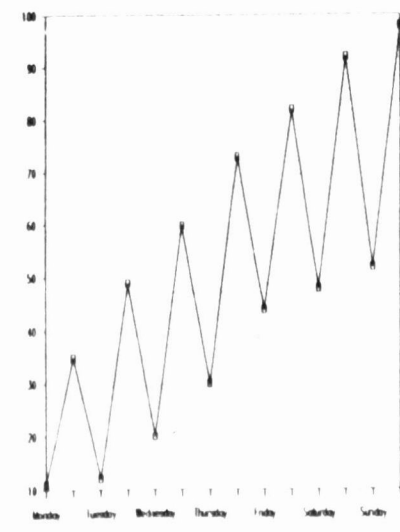

Total precip. for Wk.: 0
Total precip. for Mo.: 0



The Kings Kids of the First United Methodist Church will present a program on Palm Sunday.

Cont'd From P. 1-Kings Kids
Carey Thornberrv, Lowell El-

lerbrook, Jon Davidson, Tarah
Tampfen, Lindsey Shelton, Korey

Knorpp, Melisse Campbell,
Bridgette Leeper, Shannon Shirley,
Stephanic Floyd, Jamie Sawyer,
Catherine Chamberlain, Aaron
Harper, Nicholas Rattan and Brad
Stewart.

Everyone is invited to come and
enjoy the Easter Program.

CONGRATULATIONS

To

Richard Maxey

Upon Your Retirement After
More Than 40 Years With
The Coca Cola Company

We All Love You

Buzzy & Kathy
Paula & Larry
Marsha
Richelle & Jerry
Archie Mae
And All Of Your Grandkids

Breast Cancer Clinic Held At Medical Center

Genevieve Caldwell is pic-
tured beside the mam-
mogram machine purchased for
the Don and Sybil Harrington Can-
cer Center through a private fund-
raising drive spearheaded by
Genevieve.

The Breast Cancer Screening
Project of the Don and Sybil Har-
rington Cancer Center and the
High Plains Baptist Hospital began
a community outreach at the Medi-
cal Center Clinic in Clarendon to
be continued each Monday after-
noon through March. The Project
is designed to educate our com-
munity about the importance of
early detection of breast cancer.

The Clinic will provide low cost
screening which includes a breast

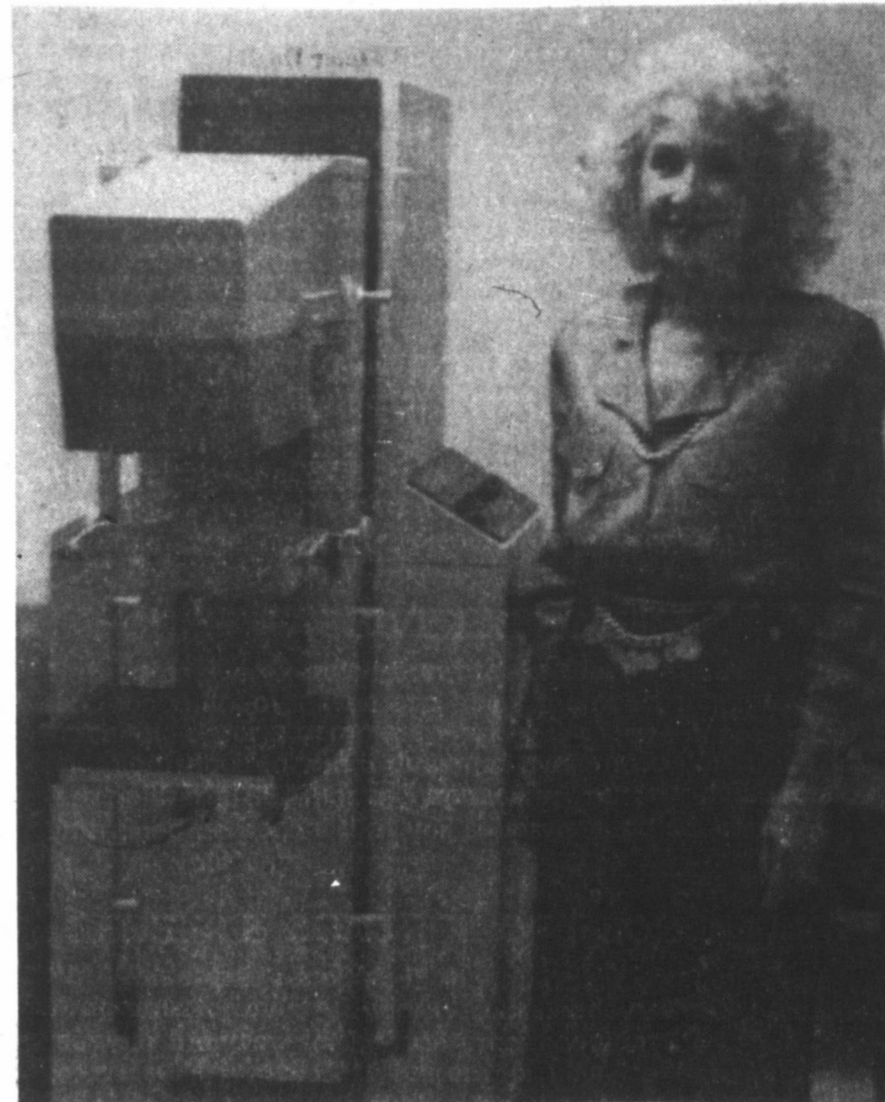

Genevieve Caldwell stands next to the mammogram machine that was at the Breast Cancer Clinic at the Medical Center on Tuesday.

exam, individualized breast self-
examination instruction and a mam-
mogram. The Clinic will be staffed
by professionals specially trained in
breast cancer detection.

For more information about the
project or to make an appointment,
please call the Harrington Cancer
Center at 806-359-4673 or the toll
free number 1-800-274-4673. Lo-
cally, call Larry White, Ad-
ministrator, Medical Center Nurs-
ing Home at 874-3760 or Dr. R. L.
Gilkey at 874-3531.

blood pressures on Tuesday,
March 7th. She will be back on
Tuesday, March 21st from 9 a.m.
to 1 p.m.

Had a nice crowd at Friday's
Musical Jam Session. Twenty
three enjoyed music by Forrest
Denton, Maxine Denton, Willard
Cook, Rachel Butler, Lucille
Swain, Nova Neuhaus, F.G. Crof-
ford and Ruby Graham.

Thanks to those wonderful
people that volunteered their
time during the month of
February to help our programs.
They are: Alta Adkins, Ann
Bunyan, Wanda Clay, Lillian
Eudy, Elmo Fortenberry, Della
Fortenberry, Imogene Glass,
Gwenith Goldston, Bud Hermes-
meyer, Pearl Hermesmeyer, Min
Ivey, Marie McCracken, Dorothy
Pitts, Shirley Pitts, Starlene Pike,
Deborah Pounds, James Pounds,
Thelma Rudder, Romona Slover,
Eda Wallin, Don Wooten, and
Carmen Wright.

Thanks for the donations
received in February 1989.
FACILITY USE-Senior Citizens
Dance Club. MEMORIALS-
Lessie Salmon, Darlene Fowler,
Zackie Bennett, Charles & Billie

Senior Citizens News

This beautiful spring weather
brought out a good atten-
dance at the 1st Tuesday Dance
on March 7th at the Community
Building. Melvin Srygley and the
Offbeats made some real good
music. We all enjoyed a lot of
goodies at intermission. Our 3rd
Tuesday Dance will be March
21st at the Community Building
from 8 to 11 p.m. Music by Melvin
Srygley and the Offbeats.
Carmen checked thirty six

Penix and Jean Baten for Marion
Cross III, Woodie & Louise Argo
for Charlie Norton. Mr. & Mrs.
Robert C. Jones for Frank Miller.
Next Tuesday, March 21st is
Blood Pressure Day at the Cen-
ter. 3rd Tuesday Dance from 8
top 11 p.m. at the Community
Building. Music by Melvin Srygley
and the Offbeats. Admission \$2.00
per person.

Calendar of Events

March 16 - 22

Thursday: Exercise 11 a.m.,
Games 12:30 - 3 p.m.
Friday: Exercise 11 a.m., Games
12:30 - 3 p.m., Musical Jam 6:30
p.m.
Monday: Exercise 11 a.m.,
Games 12:30 - 3 p.m., Dance Prac-
tice 7 - 9 p.m.
Tuesday: Exercise 11 a.m.,
Games 12:30 - 3 p.m., Birthday/An-
niversary Supper 6 p.m.
Wednesday: Exercise 11 a.m.,
Games 12:30 - 3 p.m., Arts & Crafts
1 p.m.

Senior Citizens Menu

March 16 - March 22

Thursday: Liver & Onions,
Turnip Greens, Steamed Rice,
Fruit Salad, Coconut Cream Pie,
Bread, Milk, Tea, Coffee
Friday: Roast Beef W/Nat.
Gravy, Cream Potatoes, Mix
Vegetables, Cabbage/Pineap-
ple Salad, Applesauce Cake,
Dinner Roll, Milk, Tea, Coffee
Monday: Salisbury Steak,
Macaroni & Tomatoes, Broc-
coli, Waldorf Salad, Tapioca
Pudding W/Raisins, Dinner
Roll, Milk, Tea, Coffee
Tuesday: Chicken & Dress-
ing, Giblet Gravy & Cranberry
Sauce, Yam Patties, Green
Beans, Red Jello W/Mix Fruit,
Coconut Cream Pie, Bread,
Milk, Tea, Coffee
Wednesday: Baked Ham
W/Pineapple Sauce, Buttered
Carrots, Fried Okra, Pea Salad,
Apricot Cobbler, Dinner Roll,
Milk, Tea, Coffee

Ministerial Alliance Hosting Good Friday Service

A Good Friday Service hosted
by the Ministerial Alliance
will be held on March 24, 1989 at
7:30 p.m. at the First United
Methodist Church in Clarendon.
The speaker at this service will be
Bill Hodges, pastor of the Nazarene
Church in Clarendon.

This service is one of two
fundraisers that the Alliance does
each year. A freewill offering will be
taken to be used by Ministerial Al-
liance throughout the year. The
proceeds from this offering will pro-
vide financial assistance for
desperate situations in the com-
munity and/or those needing as-
sistance traveling through.

Everyone is invited to come and
enjoy the fellowship, and help this
worthy cause.

You're Invited

Microwave Oven Cooking School

presented by your
WTU Electric Living
Consultant

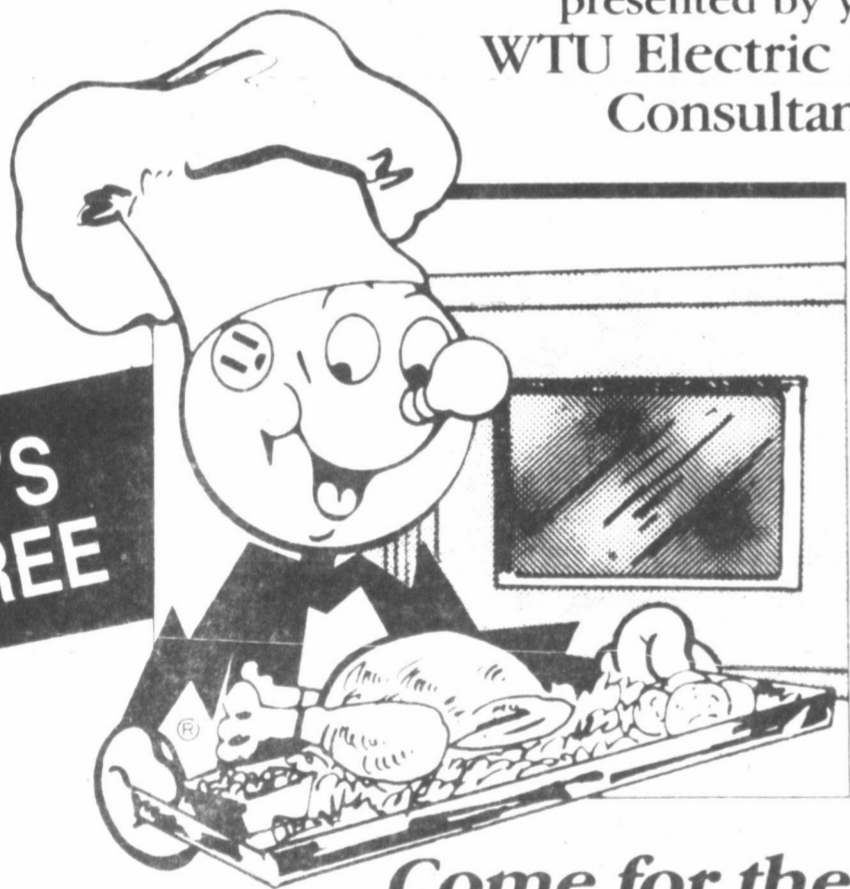

Come for the fun!

Learn to cook meats, vegetables,
and desserts in the microwave oven.
Please come for free instruction,
refreshments, and microwave brochure.

DATE: Thursday, March 23, 1989

TIME: 12 Noon - 1:00 p.m.

LOCATION:

West Texas Utilities Local Office

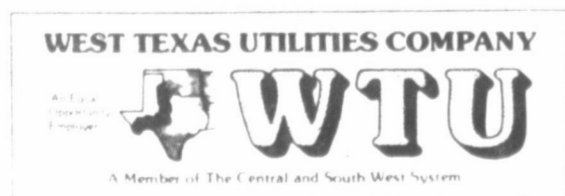

A TOTAL APPROACH TO FIGURE PERFECTION

The exclusive Pat Walker method is a total approach to
your figure problems. That's why it is effective for women
and men of all ages regardless of bone structure.

PASSIVE EXERCISE

Safe, Passive exercise that breaks down fat cells, firms
and tones flabby tissue and helps the heart to improve
circulation, for a complete work-out. There is no special
clothing required and it does not even muss your hair. We
are neither a SPA nor a Gymnasium, but we do specialize
in trained personnel that will supervise and support you
through your entire program.

SENSIBLE CONTROL OF FOOD INTAKE

Pat Walker has recognized the importance of individualized
programs for over 40 years. Your needs are not the same
as your friend's, so the first step in weight loss and
exercise is to call Pat Walker for your free time on our
exercise unit and visit with a trained counselor to
determine your exact program.

Pat Walker's

111B S. Kearney

874-3494

OPEN DANCE

Saturday, March 18

9 p.m. - 1 a.m.

Music By Slow Motion
At

PIGUN'S PUB

Cover Charge

BYOB





Tina Alexander and Brook Grisham brought home Gold Medals from Electra Track Meet. Tina won 1st place in the Discus and Brook won 1st place in the Pole Vault and the 110 Meter H. Hurdles.

Clarendon Track Team Brings Home Three Gold Medals

The Varsity Boys Track Team did an excellent job at the Electra Meet by placing 5th among 19 teams.

The team was led by an outstanding performance by Brook Grisham who won two first place medals. In route to his gold medal in the pole vault, he also set a new meet record for Electra and a new school record for Clarendon. Brooks vault of 14' broke a record scored by Alton Gaines at 13'6". Grisham also won the 110 H.H. with a time of 15.46.

Other High Point men were Randy Gaines 2nd in Pole Vault, Mike Moore 3rd in Discus and 4th in 1600 Relay, Donnie Chambless 3rd in the 800, 4th in 1600 Relay and 6th in the 400 Dash, Richard Graham 4th in 110 H.H., Mike Adams, 4th in the 1600 Relay, mark Auston 4th in the 1600 Relay.

Girls Track

The Varsity Girls Track team won 5th place out of 21 teams at the track team in Electra. Tina Alexander brought home a gold medal in the discus event. We are proud of all the girls who participated in this meet.

Andrea Edwards won 3rd in the Mile, and 4th in the 2 mile. Cindy Hermesmeyer won 2nd in the 200 M. Dash, Crystal Havens won 4th in the 100 M. Hurdles, Shawn Butler won 5th in the 100 M. Hurdles. Tina Alexander won 1st in the Discus.

The J. V. Team placed 7th among the 15 teams at the Electra Meet. Dusty Allen, Che Shadle, Hugo Vaquera, and Randy Allen had an outstanding day.

Che Shadle placed 2nd in H.J., 6th in L.J., 5th in the 400 Relay, 6th in the I.H.

Dusty Allen placed 3rd in the 100 yard Dash, 5th in the 400 Relay, and 5th in the 1600 Relay.

400 Meter Dash
1. Collier - Munday 51.55 2. Rodgers, B. - Electra - 51.84 3. Ballard - Olney 51.89 4. Fobbs - Olney - 52.04 5. Hutchel - Jacksboro - 53.60 6. Chambless, D. - Clarendon - 53.70
1600 Meter Relay
1. Olney 3:31.04 2. Electra 3:32.87 3. Quannah 3:33.82 4. Munday 3:36.20 5. Clarendon 3:39.82 6. Holliday 3:40.91

Seniors Vs. The Very Senior (Parents)

Are you ready for an evening of fun, laughter, and excitement? Then come out to the Clarendon High School gym on Tuesday, March 21, 1989, at 7:00 p.m. and watch the seniors take on their parents in a good "old" basketball game.

Mixed teams of men and women will play using women's six man, half court rules of years past with a few alterations. Half-time activities will be provided by four teams of girls Little Dribblers, ages 8-10.

Admission is \$2.00 for adults and \$1.00 for students (K-12). The event is being sponsored by the Clarendon PTA with proceeds being used to benefit student, teacher, and parent education.

Tip-Off is at 7:00 p.m., Tuesday, March 21st. Come out and support your favorite senior (be it student or parent).

Randy Allen placed 3rd in the I.H., 5th in the 400 Relay, and 5th in the 1600 Relay.

Hugo Vaquera placed 1st in the 3200 and 5th in the 1600 Relay.

Gabriel Menchaca placed 6th in the 800, and 5th in the 1600 Relay.

Nathan Lowrie placed 4th in the Pole Vault.

The team scored 45 points.

Varsity Boys Division Electra Track Meet

Discus
1. Bragg - Childress - 146'10" 2. Hutchins.L - Munday - 140'0" 3. Moore - Clarendon - 137'5" 4. Batchler - Throckmorton 123'8" 5. Peters - Seymour - 119'11" 6. Green - Iowa Park - 117'1"

Pole Vault
1. Grisham - Clarendon - 14' 2. Gaines - Clarendon - 11' 3. Sturm - Archer City - 10' 4. Lane - Quannah 10'

800 Meter Dash
1. Denney - Holliday - 2:07.66 2. Richards - Petrolia 2:07.92 3. Chambless, D. - Clarendon - 2:09.83 4. Drew - Childress - 2:10.36 5. Birk - Iowa Park - 2:13.59 6. Andreade - Munday - 2:14.24

110 Meter High Hurdles
1. Grisham - Clarendon - 15.46 2. Tabor - Henrietta - 15.78 3. Brown - Iowa Park - 15.81 4. Graham - Clarendon 15.92 5. Dugins - Iowa Park - 16.15 6. Keller - Iowa Park - 16.20

Seniors, Beware!

Seniors, Beware! This is revenge for all those diapers we changed and messes we had to clean up 18 years ago. We are in shape, on the ball, revved up, and ready to play.

We are going to make up for all those nights of lying awake wondering where you are. After Tuesday night you will be lying awake wondering what happened when we beat the socks off you.

You with your youth and energy at 18, so intelligent and wise; and we, the parents, slowed by years of hard work and maybe a touch of arthritis say, "Best beware come March 21st." We will be ready; how about you?

We love you, but we will have no mercy Tuesday night at 7:00. See you on the court!

Love,
Your Parents

New Classes Begin in K-9 Korp

New classes in obedience will begin Wednesday, March 15th, at 6:00 p.m. at the Community Center. Classes last approximately 30 minutes each Wednesday for 8 weeks. These classes are in basic dog obedience and are open to everyone. Children age 9 through 18 are free. Adults fees are \$25. When entering a class please bring a chain choke collar, a 6 ft. leash and shot records which are current. For more information call Melinda McAnear at 2377 or the Donley County Extension Office at 2141.

Older Americans are more than twice as likely as the general population to be trapped in long-term poverty. One of every three persistently poor individuals is 65 or older.

• Social Security is all that stands between nearly a third of the elderly and poverty.
• Fully 24 percent of individuals over 65 rely on their Social Security check for at least 90 percent of their income.

C & L
RADIATOR SHOP

Hwy 287 W. -
By Clark's

Chuck Needham, Owner

874-5150

OVEREATERS ANONYMOUS

Meets 6:30 Thursday nights
Episcopal Church
Parish House
301 S. Parks
No Dues
No Fees 35-9tp

The Carousel Shoppe HAS

MARTHA MINIATURE DRESSES

10% OFF FOR EASTER

Come By And Select The Perfect Dress For Your Little One.

107 S. Kearney 874 2727



Trust Your Best to the Best

Quality is in everything we do. We return your clothes spot free, fresh, and ready to wear. Search where you may, there is no finer drycleaning anywhere.

Greenbelt Cleaners
874-5024

A member of the International Fabricare Institute, the association of professional drycleaners and laundriers.

PEANUT BUSTER PARFAIT® FOR PEANUTS!



99¢*

Everybody's going nutty for the DAIRY QUEEN PEANUT BUSTER PARFAIT! With layers of DQ goodness, peanuts, and plenty of hot fudge. On sale now for under a buck! Peanuts! ON SALE MARCH 13-MARCH 26, 1989

THIS IS **DQ** COUNTRY

* Reg. TM Am. D.Q. Corp. - 1988 Tex. D.Q. Op. Coun. *At participating Dairy Queen stores

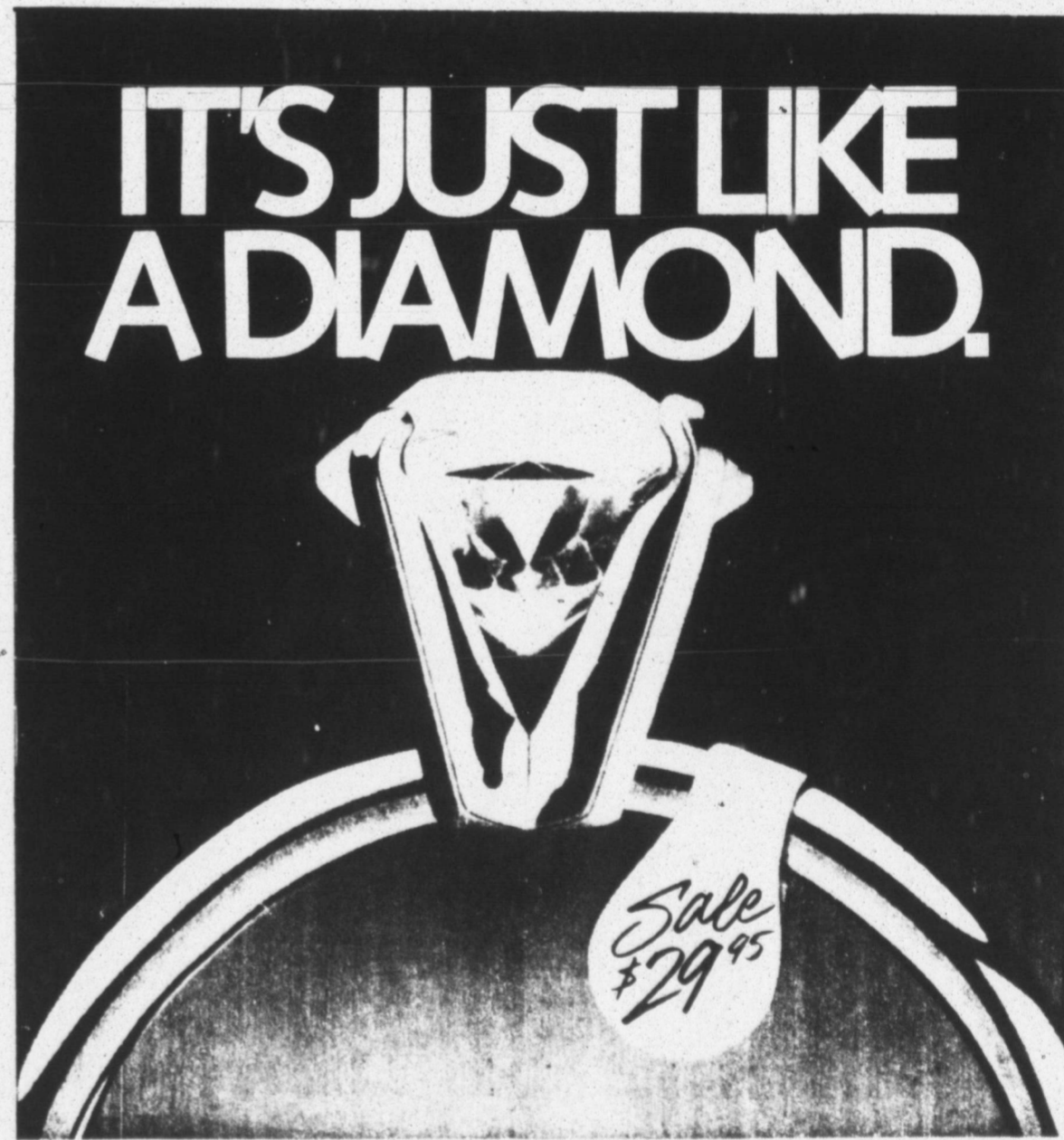

You know it's an imitation. But what about the many people today who have decided they are just like a banker? From stockbrokers to retailers, from credit unions to insurance men, to sav-ings and loans, they all seem to be saying, "You don't need a banker, we'll do just as well." Oh, no they won't. Because no one else has the banker's hundreds of years of banking experience behind them. Nor do they enjoy the kind of trust that bankers do from the majority of Americans. So why settle for an imitation when you can have a real banker at our Full Service Bank?

THE ONLY PLACE YOU'LL FIND A BANKER IS THE BANK.

FIRST BANK & TRUST OF CLARENDON

FDIC

The Clarendon Press

The Clarendon Press is published every Thursday at 106 S. Kearney and entered as Second Class Mail at the post office at Clarendon, Texas. Bob and Lynne Williams, publishers and editors.

Any erroneous reflection upon the character of any person or firm appearing in these columns will be gladly and promptly corrected upon being brought to their attention.

Subscription rates are \$13 per year in Donley County and \$16 per year out-of-county. Classified ads are \$3.50 for the first 15 words plus 10c for each word after the first 15. Standard display rates are \$2.67 per column inch.

All pictures used in The Clarendon Press which are not the property of The Clarendon Press must be picked up in 10 days after the publishing date.

TA MEMBER 1989
JEXAS PRESS ASSOCIATION

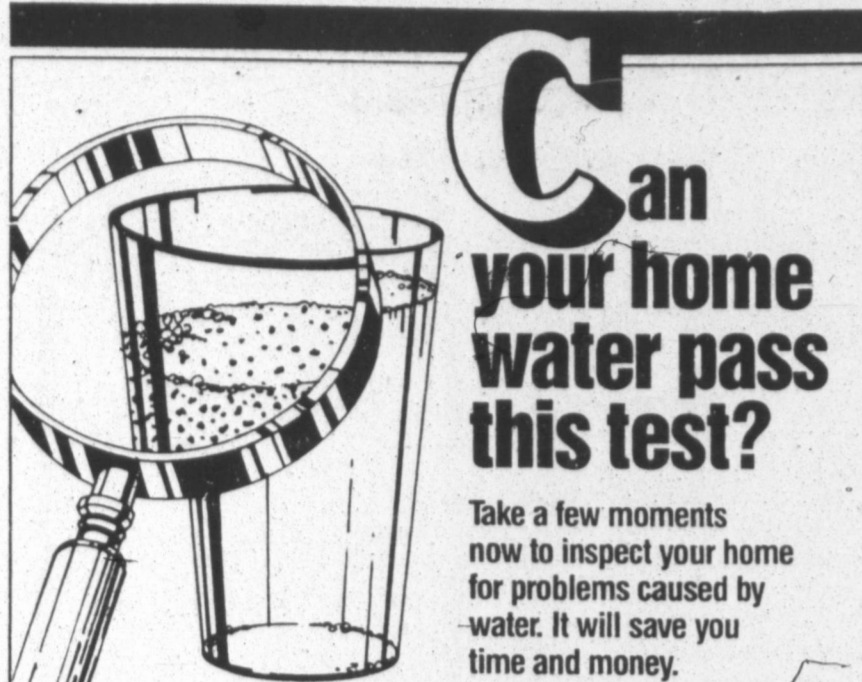

Can your home water pass this test?

Take a few moments now to inspect your home for problems caused by water. It will save you time and money.

- | | | |
|--|--------------------------|--------------------------|
| | Yes | No |
| Rusty-Red stains on sinks, lavatories, etc. | <input type="checkbox"/> | <input type="checkbox"/> |
| Blue-Green stains on sinks, lavatories, etc. | <input type="checkbox"/> | <input type="checkbox"/> |
| Soap curd ring on bathtubs, showers | <input type="checkbox"/> | <input type="checkbox"/> |
| Clogged faucet aerators | <input type="checkbox"/> | <input type="checkbox"/> |
| Soaps lose suds quickly | <input type="checkbox"/> | <input type="checkbox"/> |
| Chrome fittings etched or being eaten away | <input type="checkbox"/> | <input type="checkbox"/> |
| Rusty stains on clothing, linens, etc. | <input type="checkbox"/> | <input type="checkbox"/> |
| Excessive spotting of dishes and silverware | <input type="checkbox"/> | <input type="checkbox"/> |
| Black stains on silverware | <input type="checkbox"/> | <input type="checkbox"/> |
| Tastes and/or odors in drinking water | <input type="checkbox"/> | <input type="checkbox"/> |

If you answered yes to one or more of the above questions your Bruner/Goulds professional water dealer can help you to a better life through quality water - call now.



North American Supply Co.
P.O. Box 966
Clarendon, Texas 79226
806 874 2642

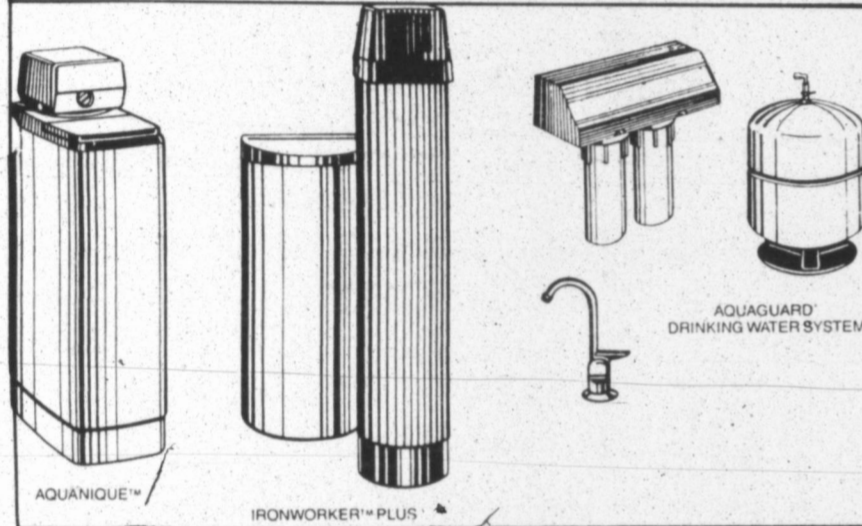

The Lions Tale

by Gene Alderson

The Clarendon Lions Club held its regular meeting at noon on Tuesday, March 14th at the Lions Hall with 29 members and guests present. Following the regular opening ceremony, the fol-

lowing guests were introduced: Michelle Bently, guest of her father, Lion Bently; Kelly Woolsey, guest of her grandfather, Lion So-Relle; Roger Estlack, guest of his father Lion Allen Estlack; Maria DeKarenty with Texas A & M Veterinarian Schools, guest of Lion Smith, and David Hooks and Kyle Allen, guest of Boss Lion Hicks. The Boss Lion called the meeting to order. A bingo report was given. Meeting adjourned.

Mark Abbott Speed

Graveside services for Mark Abbott Speed, age 40, were held at 2:00 p.m. on Saturday, March 11, 1989 in Citizens Cemetery with Rev. Tim Baldinger, Pastor of Prince of Peace Lutheran Church in Amarillo, officiating. Interment was in Citizens Cemetery with arrangements under the directions of Robertson Funeral Directors. Memorial services were held at 10:00 a.m. MST on Friday, March 10, 1989 at St. Stephen's Lutheran Church in North Glen, Colorado.

Mr. Speed died at 1:30 p.m. on Tuesday, March 7, 1989 at St. Anthony's North Hospital in Westminster, Colorado following a lengthy illness. He was born April 13, 1948 in Amarillo. He had lived in North Glen, Colorado for 1 1/2 years before moving to Evergreen two months ago. He married Sarah Orton on November 26, 1988 at North Glen. He had worked for the past year as the general manager of Puckorius & Associates Water Quality Consulting Firm and was a Civil Engineer. He earned his bachelor degree in science and civil engineering from Texas Tech University in 1970. In 1975 he became a registered professional engineer for the state of Texas and was named Young Man Of The Year by the Texas Water Utilities Association in 1978. He specialized in water quality reserve and served on the research and technical committee. He was active in the American Water Works Association and was the author of numerous publications. He was a member of St. Stephen's Lutheran Church in North Glen, Colorado.

Survivors include his wife, Sarah O. Speed of Evergreen; one daughter, Wendy Speed of Evergreen; two sons, Sean Speed of Fort Collins, Chad Speed of Evergreen; his mother, June Cook of Amarillo; and two brother, Chuck Speed of Amarillo, and Richard Speed of Amarillo.

The family requests that memorials be to St. Stephen's Lutheran Church; 10828 Huron Street; North Glen, Colorado.

Henry Francis Wurst

Funeral services for Henry Francis Wurst, age 30, were held at 2:00 p.m. on Thursday, March 9, 1989 in the First United Methodist Church in Clarendon with Rev. W. R. Lawrence, retired Baptist minister from Dumas and Rev. Terry Tamplen, Pastor, officiating. Interment was in Citizens Cemetery with arrangements under the directions of Robertson Funeral Directors.

Mr. Wurst died at 9:32 a.m. on Monday, March 6, 1989 at Amarillo Emergency Receiving Center in Amarillo following a lengthy illness. He was born November 13, 1958 in Agania, Guam and had lived in Hedley before moving to Goodnight ten years ago. He had worked most of his life as a floor and carpet mechanic. he was a member of the Pleasant Valley Baptist Church in Amarillo.

Survivors include his mother and step-father, Tena and Billy Powell of Goodnight; his grandmother, Lora B. Ruth of Amarillo; and five brothers, Robert Wurst of Gainesville, William D. Wurst of Amarillo, Thomas E. Sanders of Fort Sill, Oklahoma, Anthony Lee Wurst of Everett Washington, and James Viri Wurst of Houma, Washington.

Casket bearers were Dane McDaniels, Randy Shaw, Jerry Bristow, Randy Bristow, Mark Brinson, and Don Bristow Jr.

Elner Lee Moore

Funeral services for Elner Lee Moore, age 83, were held at 2:00 p.m. on Wednesday, March 15, 1989 in Robertson Chapel of Memories with Rev. Danny Lucas, Pastor of Southlawn Baptist Church in Amarillo and Rev. Charles Strickland, Pastor of Bolton Street Baptist Church in Amarillo, officiating. Interment was in Citizens Cemetery with arrangements under the direction of Robertson Funeral Directors.

Mr. Moore died at 3:45 a.m. on Monday, March 13, 1989 in Family Hospital Center in Amarillo following a lengthy illness. He was born February 28, 1906 in Hughes Springs, Texas and was married to Helen Bernice Dotson on January 19, 1927 at Hedley. She died in 1988. He had lived in Memphis before moving to Amarillo 16 years ago. He was employed by General Telephone Company in maintenance before his retirement. He was a member of the Southlawn Baptist Church in Amarillo.

Survivors include three daughters, Helen Bailey of Tulsa, Oklahoma, Doris Johnson of Tulsa, Oklahoma, Wanda Youree of Amarillo; one son, Billy Wayne Moore of Amarillo; one sister, Mrs. Dan Phillips of Wittmann, Arizona; three brothers, P.M. Moore of Marietta, E.H. Moore of Lelia Lake, A. W. Moore of Marietta; eleven grandchildren; and nine great grandchildren.

Casket bearers were Larry Moore, Jerry Moore, Rodney Moore, Gary Bailey, Clayton Morris, and Rick Winters, grandsons of Mr. Moore.

Family Structure Important

The Donley County Extension Service Executive Council has targeted Donley County families as part of a program planned for April 6, 1989.

The family is an important part in helping to develop the youth of Donley County into self-directing and contributing citizens.

The Executive Council and Extension Service will sponsor a "Strengthening Donley County Families" Seminar on April 6. The seminar will be for all Donley County families and will feature Dr. Lynne Thibodeaux, 4-H Youth Specialist for the Texas Agricultural Extension Service. Thibodeaux holds a doctorate degree from Texas A & M University. She will also be meeting with youth in both the Clarendon and Hedley Schools on April 6 to talk to them about self-esteem. Anyone who works in a capacity with potential to mold youth could benefit from the free seminar or the school assemblies. More information about the seminar and assemblies will be released in next weeks paper.



Humpback whales sing in accents which indicate where they're from.

EXTERIORS PLUS

A Leader In Home Improvements
Borger, Texas

Steel Siding	Steel Carports
Window Replacements	Storm Windows

(806) 274-2873 1-800-852-3692

Watch For Our Insert Coming Soon

"SO WHAT ARE YOU WAITING FOR?"

WHIRLPOOL FINANCING!

NO MONEY DOWN AND NO PAYMENTS OR FINANCE CHARGES FOR 90 DAYS!

Financing offered to qualified credit customers through Whirlpool Acceptance Corporation. Ask for details.

Eads FURNITURE & APPLIANCE

874-3412

For Quality & Service You Can Depend On.

EASTER

Fashion Specials

Our New Styles Have Arrived!

Check our In-Store Specials!

Greene Dry Goods Co.

Clarendon Texas

Grand Re-Opening April 7th & 8th

RABBIT'S APPLIANCE SERVICE

Service All Makes Of Appliances

Franchised

White-Westinghouse Appliance Dealer

We also buy and sell used appliances.

319 S. Kearney 874-3632

On Call 6 Days A Week

B. B. (Rabbit) Osburn

Spring S.A.S. Sale

At Hatch's In Wellington

This Coupon Entitles You To \$10.00 Off Any S.A.S. Shoe, Womens, Mens & Sandals
Thurs. March 16 thru Sat. April 8

Hatch Dry Goods Wellington, Texas

America's Finest Walking Shoes Since 1976

U.I.L. Contests to be Held in Clarendon

Clarendon Junior High and Elementary School will host the 1989 University Interscholastic League Literary Spring Meet on Friday, March 17, 1989. Students from Quanah, Wellington, Shamrock, Canadian, Memphis, and Clarendon will compete in a number of academic contests.

Second and third graders will participate in Story Telling. These students listen to a story and then tell the story to a panel of judges.

Third and fourth graders have the opportunity to enter Spelling and Personal Writing. For the Spelling contest, students spell sixty words pronounced at approximately 5 words per minute. In Personal Writing, contestants choose between two topics and write an essay expressing their personal opinions, thoughts, preferences, or experiences about that topic.

Picture Memory is a contest for fourth and fifth graders. Students study a collection of art prints and memorize the artist's name, the country he represents, and the name of his work. For the contest, students are shown seventeen pictures which they identify and give the information about the picture. All this must be spelled and punctuated correctly. For this contest, students are judged as a team.

Fifth and sixth graders are eligible for five different contests: Oral Reading, Spelling, Number Sense, Expressive Writing, and Listening Skills.

For Oral Reading, students select and prepare a poem to read for a panel of judges. Spelling requires students to spell 90 words given at the rate of five words a minute. Contestants are judged as individuals.

For Number Sense, participants are given a test over a large variety of Math problems which are to be solved mentally without the use of pencil and paper. The student who can solve the most problems correctly in a ten minute time period is the winner.

Expressive Writing requires students to select a topic and write an essay which attempts to get a message across to an audience. These essays do not have maximum or minimum lengths, but they are judged on how well ideas are developed and how well evidence is given to bolster the main points.

A new contest this year, Listening Skills is a contest in which students are read a variety of passage about language arts, fine arts, natural sciences, and social studies. Then they are given an objective test which measures their ability to identify main ideas and supporting ideas, draw conclusions, distinguish fact from opinion, etc.

Seventh and eighth graders have the following contest: Spelling, Expository Writing, Impromptu Speaking, Modern Oratory, Oral Reading, Number Sense, Calculator Application and Science.

For Spelling, students spell 120 words given at the rate of six words per minute. For Oral Reading students select and prepare a prose reading of about five minutes to present to a panel of judges. Number Sense at this level is similar to that contest described for fifth and sixth graders except that the problems are more difficult.

For Expository Writing, students select one of two topics and write a composition of an informative nature. They may use description or narrative writing to illustrate a point, but the essay has to be primarily expository in nature.

Modern Oratory contestants present a five to six minute speech concerning a topic which they have researched and taken a position on. They have to document the sources of their ideas and deliver the speech with out notes.

In Impromptu Speaking a contestant draws three topics, takes one minute to select the one he wants, and then prepares for one minute to present a speech without notes.

Calculator Applications requires students to perform calculations involving addition, subtraction, multiplication, division, roots, and powers. In addition to straightforward calculation problems, the contest includes simple geometric

and stated problems similar to those found in recently adopted junior high math textbooks, previous contests, and League materials related to the contest.

Contestants in Junior High Science demonstrate their knowledge in three main areas: knowledge of scientific fact, understanding of scientific principles, and the ability to think through scientific problems. This last area is a cognitive challenge requiring students to use higher learning skills in order to arrive at a "solution" or understanding of a problem without having been exposed to that particular set of scientific facts and theories to which they are exposed.

Students representing Clarendon are as follows:

Story Telling 2-3
Tracy Hankins, Tara Tamplen, Sara Newhouse, and alternate Laura Finch

Spelling 3-4
Christina Wooten, Melisse Campbell, Chandra Ford, and alternates Heather Shields; Liza Tull

Personal Writing 3-4
Kathryn Ritchie, Heather Shields, Liza Tull, and alternates Margaret McNabb; Nathan Koontz

Picture Memory 4-5
Margaret McNabb, Corey Knorpp, Stephanie Floyd, Jennifer Hatley, Amy Thornberry and Alternates Scott Bivens; Lashonda Smith

Spelling 5-6
Amy Thornberry, Heidi Clennan, Randy Haire, and alternates Julie Altman; Mandy Floyd.

Number Sense 5-6
Beth Barbee, Michael McKinney, Suzy Williams, and alternates Conrad Lucero; Jacob Smith

Oral Reading 5-6
Beth Barbee, Mandy Floyd, Jason Lee, and alternates Crispy Hankins; Logan Mays

Listening Skills 5-6
Beth Barbee, Jennifer Simpson, Todd Lindley, and alternates Mandy Floyd; Evan Williams

Expressive Writing 5-6
Jennifer Simpson, Amy Thornberry, Jason Lee, and alternates Evan Williams; Kristy Hankins

Spelling 7-8
Deana Nazworth, Monty Adams, Chris McKinney, and alternate Amy Koontz

Expository Writing 7-8
Lisa Holland, Greg Collins, Bobbie Havens, and alternate Christina Hommel

Oral Reading 7-8
Lisa Holland, Monty Adams, Greg Collins, and alternates Tommy Chadwick and Russell Estlack

Number Sense 7-8
Monty Adams and Chan Bilbrey
Calculator Applications 7-8
Chan Bilbrey and Brendan Mof-fett

Impromptu Speaking
Lisa Holland, Chan Bilbrey, Claire Boston, and alternate Monty Adams.

Modern Oratory
Krista Percival and Chan Bilbrey
Science 7
Deana Nazworth, Darren Spier, Russell Estlack, and alternates Monty Adams and Greg Collins.

Science 8
Steven Davis, Kimberly Altman, Krista Percival, and alternate Tessa Fletcher

and alternates Mandy Floyd; Jacob Smith

7th Grade: Casey Alexander, Cara Breiting, Greg Collins, Lisa Hill, Amy Koontz, Monty Adams

8th Grade: Chan Bilbrey, Steven Davis, Tessa Fletcher, Lisa Holland, Krista Percival

9th Grade: Laura Finch, Bethany Garrison, Candi Hoggard, Walker McAnear, Jessica Rogers, Chandra Ford, Nichole Wendlandt, Tarah Tamplen, Christina Wooten

10th Grade: Nathan Koontz, Catrina Burrow, Xitlali Menchaca, Corey Knorpp, Stephanie Floyd, Robert Bertrand, Scott Bivens, Mis-sie Butts, Heather Shields, Liza Tull

11th Grade: Jason Lee, Joshua Shields, Amy Thornberry, Aaron Ashcraft, Amanda Ballard, Lashonda Smith, Daniel Grizzel

12th Grade: Beth Barbee, Jennifer Simpson, Amanda Ward, Jessica Wendlandt

13th Grade: Casey Alexander, Cara Breiting, Greg Collins, Lisa Hill, Amy Koontz, Monty Adams

14th Grade: Chan Bilbrey, Steven Davis, Tessa Fletcher, Lisa Holland, Krista Percival

15th Grade: Heidi Clennan, Mandy Floyd, Suzy Williams, Kimberly Wooten, Julie Altman, Sabrina Burrow, Todd Lindley, Michael McKinney, Matthew Grizzel, Tim Hall, Conrad Lucero, John Tunstall

16th Grade: Stacey Alexander, Shauna Lauderdale, Billie Jo Lindsey, Deana Nazworth, Charlie Smith, Carrie Shields, Darren Spier, Faustino Camacho, Jared Sims, Russell Estlack, Ramona Woodard, Ashley Knorpp, Herby Sweeten, Chad Campbell

17th Grade: Kimberly Altman, Chris Garrison, Bobbie Havens, Brendan Moffett, Tracy Shadle, Stacy Thomas, Dorcas Osburn, Chris McKinney, Kelli Keown, Stacy James, Sheri Hall

HONOR ROLL

"A" HONOR ROLL - All A's on the report card or cards for the six (6) weeks.

1st Grade: Catherine Chamberlain, Diana Loveless, Jessica Shields, Lowell Ellerbrook, Jennie Hamilton, Chelsea Hand, Lindy Helms, Debby Morrow, Carey Thornberry

2nd Grade: Tracy Hankins, Sara Newhouse, Kara Thomson, Kim Alexander, Leia Deyhle, Tiffanie Hollan, Nathan Sears, Derek Shields, Johnnie Sparks

3rd Grade: Laura Finch, Bethany Garrison, Candi Hoggard, Walker McAnear, Jessica Rogers, Chandra Ford, Nichole Wendlandt, Tarah Tamplen, Christina Wooten

4th Grade: Nathan Koontz, Catrina Burrow, Xitlali Menchaca, Corey Knorpp, Stephanie Floyd, Robert Bertrand, Scott Bivens, Mis-sie Butts, Heather Shields, Liza Tull

5th Grade: Jason Lee, Joshua Shields, Amy Thornberry, Aaron Ashcraft, Amanda Ballard, Lashonda Smith, Daniel Grizzel

6th Grade: Beth Barbee, Jennifer Simpson, Amanda Ward, Jessica Wendlandt

7th Grade: Casey Alexander, Cara Breiting, Greg Collins, Lisa Hill, Amy Koontz, Monty Adams

8th Grade: Chan Bilbrey, Steven Davis, Tessa Fletcher, Lisa Holland, Krista Percival

"AB" - Both A's and B's on report card or cards for the six (6) weeks with no grades lower than a B.

1st Grade: Tommy Barbee, Camille Choate, Josh English, Seth Seale, Buddy Adams, Jon Davidson, Zack Butts, Kara Barker, Byron Burrow, Samantha Brown, Heather Pasco, Jerry Randall, Hunter Spier, Nikilia Carter

2nd Grade: Keena Ellis, Debi Hall, Cindy Hearn, Mark Howard, Steve Jaramill, Travis Sumter, Lindsay Green, Parker Kerlee,

School Menu

March 20 - March 24
Monday: Corndog W/Mustard, Macaroni & Cheese, Blackeyed pea, Tossed Salad, Fruit Bars, Milk

Tuesday: Beef Stew W/Veg., Cheese Wedge, Corn Bread, Cole Slaw, Pears, Milk

Wednesday: Turkey Teteriz-zine, Green Beans, Tossed Salad, Hot Rolls, Peaches, Milk

Thursday: Chip O Pie W/Cheese, Ranch Style Beans, Tossed Salad, Cherry Kalache, Milk

Friday: Easter Holiday

Audra Kirkland, Jodie Lockeby, Blake Osburn, Stephanie Smith

3rd Grade: Kasi Ashcraft, Kathy Bryley, Gina Cannon, Lamanda Haggard, Clarissa Smith, Nicky Sumter, James Thomas, Tyrell Wortham, Melisse Campbell, Blake Deyhle, Lindsey Eads, Aaron Harper, Keith Kidd, Nicki Lumpkin, Marian Seale, Caleb Stroud, Pati Cenicerros, Matthew Ariola, Brandy hawkins, Tish Holman, Jenny Roberts, Mandy Weatheron, Brad Stewart

4th Grade: Margaret McNabb, Carrie Moore, Tangelia Smith, William Boston, Chris Chamberlain, Derrick Shafer, Carye Adkins, B.J. Hamilton, Jana Breiting, Renee Cannon, Kyle Davis, B.J. Faires, Laura Hommel, Wade James, Jason Morrow, Kathryn Ritchie, Doug Tucker, Josh Mondragon

5th Grade: Lynn Hearn, Jacob Smith, Evan Williams, Jeremy Woodruff, William Frazier, Jennifer Garrison, Somer Harper, Jennifer Hatley, April Hommel, Traci McKinney, Lana Moffett, Kathi Tunstall, Codilee Adams, Christy Byrd, Louis Ellerbrook, Kristy Hankins, Samantha Mincey, Tamra Williams

6th Grade: Heidi Clennan, Mandy Floyd, Suzy Williams, Kimberly Wooten, Julie Altman, Sabrina Burrow, Todd Lindley, Michael McKinney, Matthew Grizzel, Tim Hall, Conrad Lucero, John Tunstall

7th Grade: Stacey Alexander, Shauna Lauderdale, Billie Jo Lindsey, Deana Nazworth, Charlie Smith, Carrie Shields, Darren Spier, Faustino Camacho, Jared Sims, Russell Estlack, Ramona Woodard, Ashley Knorpp, Herby Sweeten, Chad Campbell

8th Grade: Kimberly Altman, Chris Garrison, Bobbie Havens, Brendan Moffett, Tracy Shadle, Stacy Thomas, Dorcas Osburn, Chris McKinney, Kelli Keown, Stacy James, Sheri Hall

Clarendon Elementary & Junior High

Citizenship Awards Fourth Six Weeks

GRADE	TEACHER	GIRL	BOYS
EC	L. Thomson	(a.m. class) (p.m. class)	Patrick Childs Oscar Sanchez
K	R. Duncan	Lindsey Shelton	Greg Leeper
K	K. Simmons	Mindy Auston	Taner Blackburn
K	J. Zehr	Jamie Cox	Rhorry King
1st	E. Ellerbrook	Stacey Cenicerros	Seth Seale
1st	F. Tucker	Samantha Brown	Carey Thornberry
2nd	G. Guinn	Kara Thomson	Gerardo Vaquera
2nd	G. Hankins	Johnnie Sparks	Derek Shields
3rd	N. Jones	Kasi Ashcraft	Chris Taylor
3rd	H. Land	Lindsey Eads	Jimmy McAnear
3rd	F. Moreman	Tyra Creswell Mary Hodges	
4th	B. Gooch	Tangelia Smith	Carye Adkins
4th	T. Mooring	Liza Tull	Josh Mondragon
5th	J. Campbell	Kathi Tunstall	Evan Williams
5th	M. Nelson	Amanda Ballard	Robert Taylor
6-1	L. Mathiason	Lisa Laxson	John Tunstall
6-2	C. Duncan	Kimberly Wooten	Jason Ham
7-1	C. Adams	Christina Guinn	Ernie Lee
7-2	K. Hatley	Shauna Lauderdale	Greg Collins
8-1	B. Sharp	Stacy James	Chris McKinney
8-2	H. Estlack	Krista Percival	Steven Davis

DR. JACK L. ROSE

Optometrist

220 S. 10th Ph. 259-2216 Memphis

Mr. Burger

(Clarendon Only)

Special

Tuesday: Mar. 14 thru Sunday: Mar. 19

Small Drinks

39¢

Footlong Chili Cheese Dog With Fries or

Grab Bag Chips \$.2.29 plus tax

HELP WANTED

CALL IN ORDERS

Apply in person Phone 2811

Store Hours: Sunday thru Thursday 10 a.m. to 10 p.m. Friday and Saturday 10 p.m. to 11 p.m.

Amiga's and No More

Hwy 287 E Special!

The Best Coconut Creme Pie In Town!

\$19.95 each

Thursday Only

[Limit: 1 per Customer]

Christian Counseling

Biblical, Personal, Family

Philip R. Stroud

Ministering with the CHURCH OF CHRIST (3rd at Carhart)

P.O. Box 861 Clarendon, TX 79226

Telephone 1-806-874-2495

CORNELL REAL ESTATE

....Offering Clarendon's Best!

Call Carol For Appointment 874-3649 or Dude 3377

"We Need Good Listings Now"

Dude Cornell-Broker 874-3377 or 874-3320

Call: Carol Hinton 874-3649 or 874-3148

Lee's Detail Service Special Of The Week

Wash, Wax and Vacuum

\$25.00

Hwy 287 E, Clarendon

874-5060

It Pays to Advertise in The Clarendon Press.

NOW OPEN

Creme of the Crop Family Hair Care

Perm Special Thru Easter



Helen Johnson 874-5089

Senior Citizens Discount

108 S. Kearney

Open Tuesdays-Saturdays

CONGRATULATIONS!

The Community of Clarendon and GTE

Would Like To Congratulate Donald Garman

For His Volunteer Service To Golden Spread Council #562



A Check For \$1,000 From GTE Is Being Contributed To The Golden Spread Council #562 Under The GTE Volunteer Incentive Program.



LUCK 'O' THE IRISH



FOOD SALE

WILSON'S CERTIFIED

SLICED BACON 1 LB. PKG. **\$1.29**



CORN KING BONELESS FULLY COOKED

WHOLE HAMS

6-8 LB. AVERAGE

\$1.39

LB.

- REUBEN BRAND FRESH LEAN BEEF BRISKET **\$1.69** (2-4 LB. AVG. LB.)
- FRESH FRYER (FAMILY PACK) **79¢** (LB.)
- DRUMSTICKS **\$1.99** (LB.)
- WILSON'S ALL VARIETIES REG./POL./BEEF/CHEESE **\$1.99** (LB.)
- SMOKED SAUSAGE **\$1.29** (LB.)
- SELECT LEAN FRESH **\$1.29** (LB.)
- PORK STEAK **99¢** (LB.)
- FRESH BOSTON STYLE PORK ROAST **\$1.49** (LB.)
- FRESH COUNTRY STYLE PORK RIBS **89¢** (12 OZ. PKG.)
- WILSONS ALL MEAT FRANKS **\$1.99** (LB.)
- DELTA PRIDE FARM RAISED CATFISH NUGGETS **\$1.99** (LB.)



WOLF BRAND WITH BEANS CHILI 15 OZ. CAN **88¢**



PLAIN-NO BEANS WOLF BRAND CHILI 15 OZ. CAN **88¢**

SHUR SAVING SALTINES CRACKERS 16 OZ. BOX **48¢**

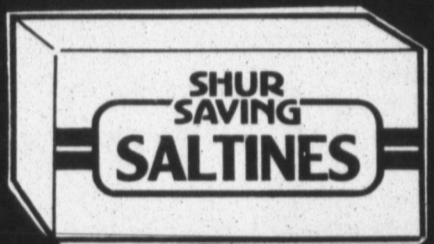

SHUR SAVING VITAMIN D MILK PLASTIC JUG 1/2 GALLON **89¢**



ULTRA PAMPERS 66 SMALL/48 MED./32 LARGE ULTRA DIAPERS BOX **\$9.99**



NICE n' SOFT WHITE/ASSORTED BATHROOM TISSUE 4 ROLL PKG. **99¢**



ASST./DESIGNER ABSORBENT JUMBO ROLL BRAUNY TOWELS **79¢**



COCA-COLA 6-12 OZ. CANS **\$1.49**



2 LB. BAG CASSEROLE PINTO BEANS **88¢**



KELLOGG'S CEREAL RAISIN BRAN 25 1/2 OZ. BOX **\$3.19**



GARDEN STYLE/TRADITIONAL SPAGHETTI SAUCE RAGU 32 OZ. JAR **\$1.89**



2.39 SIZE CHIPS® DORITOS PKG. **\$1.99**



PACE MILD/MED./HOT PICANTE SAUCE 16 OZ. JAR **\$1.39**



RED RIPE SALAD TOMATOES **39¢** (LB.)



GRAPEFRUIT 5 LB. BAG **\$1.49**

SALAD SIZE-HASS AVOCADOS 5 FOR **\$1**

NO. 1 RUSSET POTATOES 15 LB. BAG **\$2.69**

CALIFORNIA NAVEL ORANGES LB. **39¢**

CALIFORNIA CRISP CARROTS 2 LB. BAG **49¢**

GARDEN FRESH WHITE ONIONS LB. **29¢**

VAN CAMP PORK & BEANS & RANCH STYLE BEANS MIX OR MATCH 3 16 OZ. CANS FOR **\$1**

GLADIOLA CORNBREAD MIX 5 FOR **\$1.00** (6 OZ. PKGS.)

KRAFT MACARONI & CHEESE DINNERS 2 FOR **\$1.00** (7 1/4 OZ. PKGS.)

LUCKY LEAF APPLE JUICE 64 OZ. BTL. **\$1.39**



Shurfine BLEACH 69¢ GAL.



FROZEN STILLWELL COBBLERS 2 LB. PKG. **\$1.98**



ASSTD. TOOTHPASTE AQUA FRESH 6.4 OZ. PUMP **\$1.99**



ASSTD. SELSUN BLUE SHAMPOO 4 OZ. BTL. **\$2.89**



THRIFTWAY COUPON! TABLETS/CAPLETS ASPIRIN BAYER 100 CT. BTL. **\$1.99**



LIMIT 1 WITH COUPON THEREAFTER \$3.49 COUPON EXPIRES MAR. 22, 1989

DAIRY DELIGHTS KRAFT TOUCH OF BUTTER SPREAD 3 LB. BOWL **\$1.99**



SWANSON CHICKEN/TURKEY/BEEF MEAT POT PIES 7 OZ. BOX **59¢**



B&R THRIFTWAY

WE ACCEPT FOOD STAMPS...WE RESERVE THE RIGHT TO LIMIT

DOUBLE COUPONS WEDNESDAY & SATURDAY Double Value Coupons Cannot Exceed \$1.00 Double Coupon Offer Excludes Free Coupons, Cigarettes and Tobacco Coupons Double Value of Coupon Cannot Exceed Value of Item Purchased

Store Hours Mon.-Sat. 8a.m.-8p.m. We Accept WIC Cards 874-3164

PRICES EFFECTIVE MARCH 15-21, 1989

SLICES VELVEETA 16 OZ. PKG. **\$2.69**



SHURFINE BUTTERMILK OR CHOCOLATE MILK **\$1.19** (1/2 GAL.)

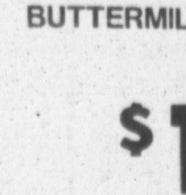

FISHER BOY FISH NUGGETS 20 OZ. BOX **\$1.98**



T for TEXAS

by T. Lindsay Baker

Three Boys In The Same Grave

I found all three of them there just like I'd heard—the three boys killed by the Indians at Proffitt in 1867.

Their grave stands at the back of the little country cemetery on U.S. 380 about 8 miles west of Newcastle in Young County. They were the first ones there. They started the graveyard.

Now they are all but forgotten by everyone except for a handful of local residents and maybe a few historians like me. A crudely laid red brick wall surrounds the burial, and a tree grows up inside of it. At one side some iris plants rustle in the West Texas breeze. It's almost always peaceful there.

How did the three boys end up in the grave together?

The story goes back to the summer of 1867, when they were tending cattle on Elm Creek, then on the fringe of white settlement. They were Patrick Euell Proffitt, Rice Oarlon, and Reuben Juhnson, all of them teenagers. They were working as cowboys on the FitzPatrick Ranch.

On July 17, 1867, the three boys went to work branding cattle in the valley of Elm Creek. The area had been the scene of a devastating Indian raid only three years before. Maybe they felt safe from attack, thinking that the warriors wouldn't descend on the same valley a second time. Whatever the case, they unwisely left their guns on their saddles and allowed their horses to graze while they worked.

Without warning a Comanche war party rode into view. The three boys made for their horses—and their firearms—but they weren't lucky enough to reach them.

The Comanches cut them off from their guns and horses. Without defense, the three young men were shot down by the warriors, who scalped them and left them where they fell.

Local settlers buried the three boys near the place where they were attacked, placing all three of them in the same grave. Their burial became the site for other graves in the years that followed, becoming the cemetery for what grew into the town of Proffitt.

The nearby town bearing the same name as one of the ill-fated teenagers was founded by the dead man's brother, John W. Proffitt. It prospered for a number of years before declining to become a scattered rural community.

Since the deaths of the three young men, descendants of their families and members of the local community have tended their grave. In 1966 historically minded citizens of Young County placed a new marker at the grave, which briefly tells the story of the three deaths.

When I opened the gate to the cyclone fence into the Proffitt Cemetery to look for the victims of the Indians that I'd heard were buried there, I didn't know what to expect as I wandered among the tombstones. Then, when I found the low brick wall around the burial, somehow my mind went back to that hot day in July 1867—the sorrow of the families, the desire for revenge, and the blood from the three boys that still nourishes the tree that grows from their grave.

Home-Based Business

A Home-Based Business Shortcourse will be held at Tarleton State University in Stephenville on April 7-8, 1989.

The shortcourse will begin Friday afternoon with a tour to several home based businesses in the area with a reception following the tour. Saturday's program will include a keynote speaker, luncheon, concurrent sessions dealing with the aspects of Home Based

Business by a variety of speakers, and a summary session. The shortcourse is sponsored by the Texas Agricultural Extension Service, Small Business Development Center and the Home Economics Department of Tarleton State University.

For more information contact the Donley County Extension Agent.

Ladies Auxiliary To The V.F.W. Meet

March 2, 1989 the Ladies Auxiliary to the VFW Post #7782 met at the Community Center. Thirteen members were present with guests Alta Joy Zamora, Senior Vice President District 13 and Florene Leinen, Past President District 13.

The Buddy Poppy sale was discussed, with Naomi Rippetoe named chairman of the sale. The Poppies will be sold the week of Memorial Day. More information on the Buddy Poppies later.

It was voted to meet the third Thursday each month at the Senior Citizens building at 3:30 p.m. The first Thursday meeting will remain at 7:00 p.m. at the Community Center.

Sgt. Mike Thomson of the Texas Highway Patrol, Department of Public Safety will be speaking to us on safety. This is one of our yearly requirements.

The Nursing Home residents would like to thank Luz Taylor, Wanda Dromgoole, Lorene Helton, Carmen Wright and Ellie Wilkerson for the lovely refreshments they brought February 27.

We will see all members at the Senior Citizens Thursday at 3:30.

Quail Class of 1949 to Have Reunion

The class of 1949 of Quail High School will meet in the home of Avyrilla and Delbert White for their 40th Class reunion. We invite anyone to come by an visit. We will meet from 1 p.m. til 7 p.m. The banquet will be at the Quail Community Center starting at 7 p.m.

Come renew all friendships and have fun with us.

Five miles West of Quail on highway 203 and 1 mile North. Look for balloons and signs.

For thickening gravy, sauce or stew, sprinkle instant mashed potatoes into the mix and stir. Lumps dissolve immediately.

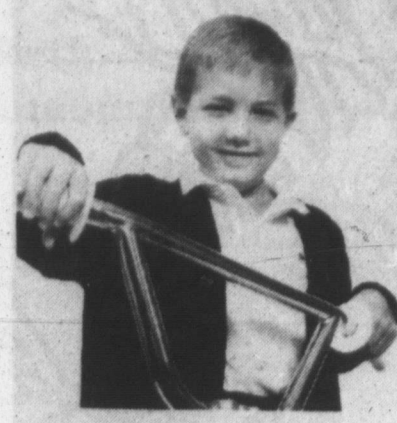

BRIAN MCCOLLISTER
Bike-A-Thon Poster Patient
St. Jude Children's Research Hospital

"Wheels For Life" Bike-A-Thon

St. Jude Children's Research Hospital announced today that Brenda McConnell will coordinate the St. Jude Children's Research Hospital "Wheels For Life" Bike-A-Thon in Clarendon on 4/15/89.

Founded by Danny Thomass in 1962, St. Jude Children's Research Hospital is the largest childhood cancer research-treatment-education center in America. St. Jude Hospital is non-sectarian, interracial and provides medical care for over 3,200 active patients. Currently, over \$183,000 is needed each day to keep the doors open. These funds come primarily from public contribution.

The Bike-A-Thon program this year is dedicated to Brian McCollister. Brian, a native of Louisiana, was diagnosed with leukemia in October, 1984.

For the next two and a half years he underwent chemotherapy. Today, Brian is in remission and visits St. Jude Hospital for routine check-ups. Brian is a living example of the progress and success of the research, patient care, and educational programs of this internationally recognized hospital.

We are grateful for the concern that Mrs. McConnell has for our work and we hope the citizens of Clarendon will support the Bike-A-Thon to help provide the funds that are needed to preserve the world's greatest asset ... "Our Children"

Donley County Fares Well at Houston Stock Show

By Tim Trimble

After the Fort Worth Stock Show, many Donley County 4-H'ers came back a little disappointed in the outcome. But, they picked themselves up, worked harder, and it payed off for many of them at the Houston Stock Show.

In the market steer division, Scott Myers placed 5th with his Red Angus, Buddy Howard placed 7th with a Shorthorn steer, and Chad Campbell placed 10th with his Hereford.

In the market lamb division, Buddy Howard also placed 13th with his light weight medium wool lamb. This may be Donley County's first lamb to place at Houston, according to some.

In the market swine division, Donley County 4-H and Clarendon FFA managed to get eight pigs out of 13 past the sift at Brenham for a chance to compete at Houston. There were approximately 3,500 barrows at Brenham and around 1300 got to go to Houston after the sift. Clarendon FFA member, Todd McAnear, was the only one that managed to place a barrow at Houston with his light weight Duroc placing 16th.

Donley County 4-H member Monty Joe Adams placed a Tom in the Market Turkey Division, which is very tough to do raising them this far north.

Major stock show trips are often the highlight of 4-H animal projects, and is what most 4-H'ers are shooting for, and placing at a major stock is just the icing on the cake. But there is more to 4-H projects than a blue ribbon.

4-H projects offer youths opportunities for "critical thinking".

Through planning and carrying out a project, youths learn to apply critical thinking skills to real-life problems.

For example, in a project involving raising any animal, a youngster

must do the following: 1 - Compare and contrast animals as the basis for deciding which to keep or cull, to breed or to buy. Basic training of this nature is done in livestock judging. 2 - Identify characteristics of individual animals that qualify or disqualify as certain breeds or species. 3 - Learn nutritional ration ingredients needed for health and growth and identify animal parts and their functions. 4 - Use previous experience and subject matter learned to recognize health problems and courses of action needed. 5 - Identify errors through recognizing and correcting mistakes. 6 - Identify the main idea and generalize from the particular animal project to the entire food ecosystem as the youth determines profit or loss at the market price.

A 4-H project can do much more than teach a child how to show and compete. It can, in fact, teach critical thinking skills which can be generalized to every area of a young person's life.

National Ag Day Set For March 20

National Agriculture Day, set to honor the nation's food and fiber providers, will be observed March 20.

According to Tim Trimble, county agent with the Texas Agricultural Extension Service, business and consumer groups will join in honoring farmers and ranchers on that special day.

County, state and national observances of Agriculture Day will be keyed to the continuing theme of "Honoring America's Providers".

Coordinated nationally by the Agriculture Council of America in Washington, D. C., the Agriculture Day observance is a part of National Agriculture week, March 19 - 25.

"National Agriculture Day and Week observances can reflect the ideas and wishes of every community and county," said the agent

Trimble said the celebrations can increase awareness of agriculture's accomplishments and the challenge it faces in meeting the world's food and fiber needs.

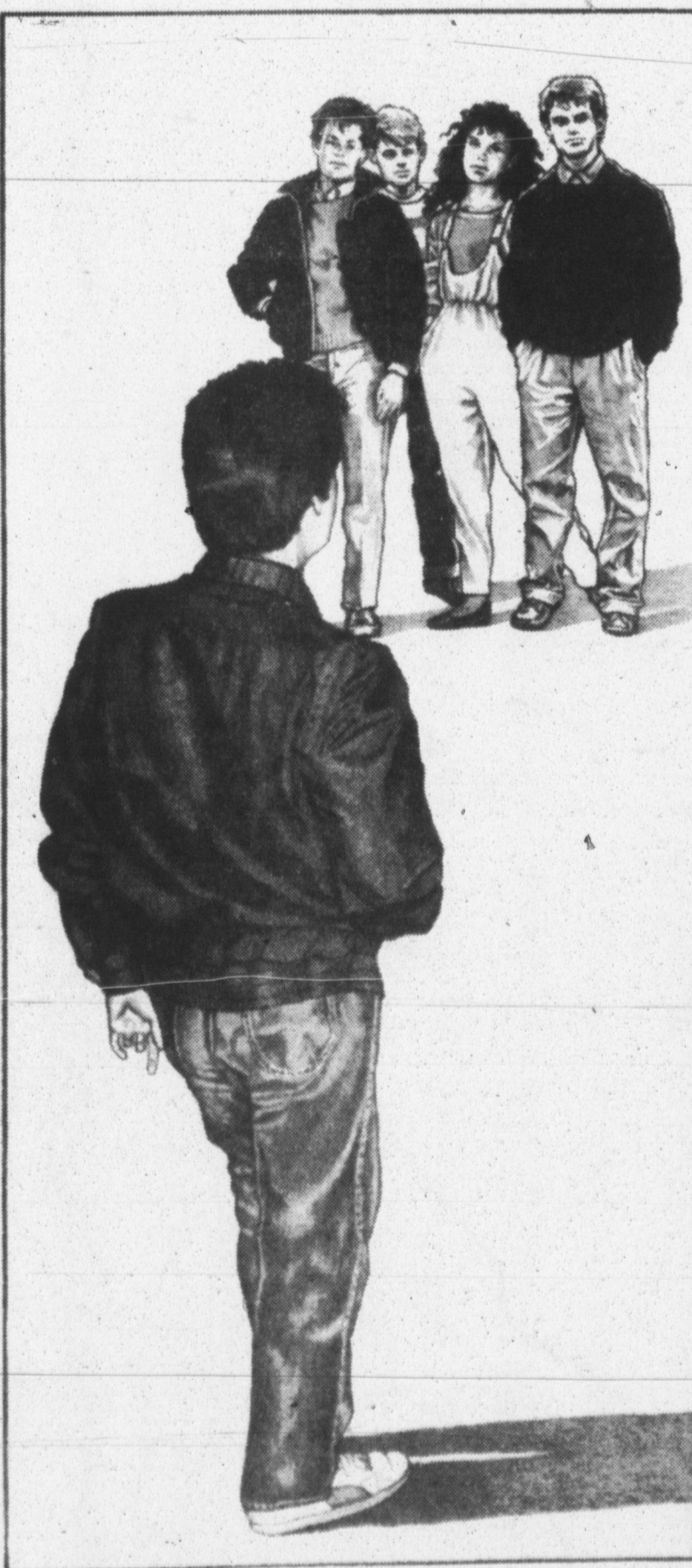

Get To Your Child Before The Pressure Does

Peer pressure. We've all experienced it. Remember how hard it was to say "no" when you were a kid, even if it meant doing something you knew was wrong? Young people today admit that pressure to use drugs is intense. As a parent, it's your job to give your child the facts about the dangers of drug abuse. Talk to your kids. Get to them before the pressure does.

Christian Church
3rd & Gorst
Clarendon
874-2827

Worship with us, 10:30 am or 6:00 pm, Sundays.

THE DONUT STOP

Will Open For Business
Thursday, March 16
6:00 a.m.

Watch For Our Grand Opening
Coming Soon!

Our Apologies For Opening A Day Late -
Our Equipment Arrived Late



Girl Scouting Week

Honoring the Girl Scouts in Clarendon

Andrea Edwards
Shannon Myers

Toni Breittling
Kelly Edwards
Megan Williams

Cara Breittling
Christel Green
Deana Nazworth

Aaron Ashcraft
Amanda Ballard
Christy Hankins
Mandy McAnear
Lana Moffett

Kasi Ascraft
Melissa Campbell
Laura Finch
Candi Hoggard
Jessica Rogers

Kim Alexander
Kirsten Bertrand
Keena Ellis
Lindsay Green
Debi Hall
Tracy Hankins
Tiffany Hollan
Audra Kirkland
Janiah Mondragon
Sara Newhouse
Stephanie Smith
Kara Thompson
Jennifer Wright

Shauna Adams
Kara Barker
Catherine Chamberlain
Camille Chaote
Jaclyn Griffin
Chelsea Hand
Kala Holland
Dianna Loveless
Debbie Morrow
Heather Pasco
Jessica Shields

and throughout our nation



- Adams Kerr-McGee Service Station
- Chamberlain Motor Company
- The Clarendon Press
- Donley County State Bank
- The Donut Stop
- Greene Dry Goods
- Jack Owens
- Janey's Beauty Shop
- John Morrow Drilling Service
- Mary's Country Kitchen
- The Print Shoppe
- The Recreation Center
- Robertson's Funeral Directors
- Security Abstract Company



GIRL SCOUTS

Letter to Editor:

Well, who would ever thought I would be writing a letter to the Clarendon Press. But I know now what so many people meant, when they wrote me, how they look forward to getting their Clarendon paper and waited days and days to get it. Well, it takes me 11-days to get the paper. I just received Feb. 23rd paper, and it is March 3. I think it took only 10 days for the Pony Express to send mail from California to Texas.

I hope you got my address changed from Mercury to Pahrump, its about 40 miles closer, so maybe I'll get it earlier. It's amazing how one can look forward to hometown news.

Just kidding, not really mad about not getting the paper earlier, but it is true, it takes us about 10-11 days to get the paper. I know the post office does what it can, the process is just slow.

I hope your subscribers who have written about your paper so late, will realize that it is not The Clarendon Press's fault. It is indeed a rare occasion when the paper is not mailed from Clarendon each Wednesday afternoon.

The weather has been about 80 to 85 degrees, but everyone tells me just wait until summer, when it

Naomi's News

by Naomi Green

Louvetta Estes has recently returned from San Antonio where she assisted John and Melissa Butts while they were involved with surgery for Kyle Baily. While she was there Eric Butts celebrated his fourth birthday.

Mac and Duane Naylor visited at the nursing home at Memphis Saturday with Thelma Hall. They came on to Clarendon to visit with Royce. Saturday night they spent the night with the H.A. Greens along with other house guests Lindsay Green and Stephanie and Ellen Patterson. Sunday morning they went to Memphis and brought Thelma to Clarendon for the day.

Tiffany Patterson spent Saturday night with the Jerry Green family.

Lena Mae Graham was honored with a birthday dinner in the home of the J.R. Grahams. Those to attend were: Wanda and Haskell Talley of Memphis, Cathy and Allen Graham of Panhandle, Betty and Martin Hermesmeyer of Groom, Jerry, Mary, Christel and Little Jerry Green and the hosts the Jitter Graham family.

Aline and Robert Partain took Willine Judd and Naomi Green to Lubbock where they visited with Mary Belle Kyle at South Park Medical Center. Paul came and took them to lunch and a tour of Mary Belle's and Paul's home and work shops. We found Mary Belle on a heart monitor to see if a pace maker was justifiable.

Velma Hearn's brother and his wife Mr. and Mrs. Kenneth Lyle of Dallas are visiting with the Charlie Hearn's this week.

Zack and Jamie Fichte of Weatherford rode to Clarendon with Ellen Patterson and are

becomes 115 degrees. We only live about 10 miles from the California state line, and it enters death valley from there.

This is a beautiful little valley, surrounded on all sides by mountains, some have snow on top of them. It looks strange, to see all these rocks and cactus and no grass. Most of the yards don't even have grass, I think the annual rain fall here is 4 inches.

I was appointed editor of the Pahrump United Methodist Church paper, the Mountain Views, while I was in Texas, it is published once a month, hope I can make the deadline.

I would like to tell all my friends who make the bit, that I would get bored of doing nothing, its been like heaven so far, but I will say this, it takes exactly 29 steps to go from front to back of this trailer.....

I also, would like to say thank you to Maggie and Rhonda for all the help they were to me in getting the paper out and getting things transferred from me to Bob.

Helen Woody

Dear Editor,

Just thought I would sound off. The people of Clarendon do not deserve anything from our Congressman in Washington. He was good enough to come to Clarendon to talk to you and receive from you some ideas about what you wanted him to do. Even if you don't like him, he is your link to Washington, the only one you have to represent you. Why is it so hard for you just to come and be counted or get some questions answered that effect you and your country.

Our country is directed by the people that live in it and take part. Nobody cares or wants to speak out against the wrong that goes on. Stay at home and receive what you deserve...NOTHING.

In case you are wondering, Congressman Bill Sarpalius was here Saturday.

Don Altman

spending time with their grandparents Jack and Jacquetta Owens during their spring break.

L.A. Watson went to see his brother "Hap" Watson at Groom Sunday. Hap is doing well after his recent hospital stay.

Martin Baptist Church surprised their pastor, Rev. Johnny Hogatt with a birthday party after church Sunday evening.

Larry, Janet and Rene Watson visited with Rose Lee Watson Sunday afternoon. Bobby and Bill Moss of Lamont California were also visitors.

Rose Lee Watson visited C. I. Casteel at the Medical Center Nursing Home Saturday.

Bobby and Bill Moss met Jathen Moss from Louisiana here at Clarence Moss home to take him back to Lamont California to live with them for two years. While they were here Bill's mother from Fritch Mrs. Oneta Cavett came to visit. Irene and George Williams, and Shirley and Rabbit and Dorcas Osburn were also guests in the Clarence Moss home.

Oddie Moss and some other Senior Citizens sing with the Medical Center patients ever first and third Wednesday. Come and enjoy the music.

Friendship Club will meet with Thelma Rudder this Tuesday. Aaryn and Trent Mooring of Panhandle, Texas spent the weekend with their grandparents, Bill and Nova Mooring.

H.U.D. Landlords Asked to Attend Meeting

All perspective landlords and present landlords for the H.U.D. program are asked to attend a meeting at Clarendon Texas Thursday, March 16, 1989. The meeting will be held at the Donley County Courthouse, in the courtroom, located at 300 S. Sully at 7:00 p.m.

H.U.D.'s aim is to explain the regulations and procedures of our Housing Program. The local Housing inspector and the area inspectors supervisor will be present to answer your questions and explain procedures.

Birth Announcements

Rick and Cynthia Gerner of Port Lavaca proudly announce the arrival of a daughter on February 2, 1989. Her name is Kelsie Nicole and she is 19 inches long and weighs 6 lb. 10 oz.

Kelsie has a big sister, Candace. Her grandparents are Mr. and Mrs. George Williams of Clarendon and Mr. and Mrs. Raymond Ruddick of Port Lavaca. Great grandparents are Mr. and Mrs. C.F. Moss of Clarendon and Mr. Anton Kalisek of Port Lavaca.

T. and Nancy Mullins proudly announces the arrival of a granddaughter. Kendra LeAnne Mullins was born at 2:45 p.m. on March 1, 1989 in the Stamford Hospital. She weighed 7 lbs. 4 oz., was 20 inches long, and has black curls. Billy and Natalie Mullins of Stamford are her parents. Mrs.

Lola Brown of Hedley and Bob and Mildred Jewell of Estelline are her great-grandparents.

Pam and Noble Watson would like to announce the arrival of their daughter, Shelby Jade on March 1, 1989. She weighed 6 lbs and 4 oz. and was 19 1/2 inches long. Grandparents are Jo Ann Jack, Clarendon, Texas and Glenna Watson of Amarillo, Texas. Great grandparents are Mr. and Mrs. Carl Watson, Rocky, Oklahoma, Mr. and Mrs. John Stovall, Granite, Oklahoma and Mr. and Mrs. Lester Blackerby of Clarendon, Texas.

Program on Drug Abuse to be Held at Hedley

by Nina Riddlespurger

Donley County Sheriff, Jimmy Thompson will present a program on drug and alcohol abuse among teenagers at the Hedley School Cafeteria on Tuesday, March 21 at 7:30 pm. Hedley Constable, Blackie Johnson will assist Sheriff Thompson in this program. All students of Hedley School and all parents are encouraged to attend this meeting. Anyone who is concerned with this problem is welcome. If you don't believe that there is a problem in our community with drug and alcohol abuse then you should be in this meeting. Sheriff Thompson will have displays of firearms and drug paraphernalia taken in drug raids made in Donley County. This is a problem that every member of the Hedley Community should be very concerned with. Every one is encouraged to attend.



Start Walking

Spring is a Great Time



THE DOCTOR'S WALKING BOOK

HOW TO WALK YOUR WAY TO FITNESS AND HEALTH

- FEATURING THE COMPLETE "WALKER'S WEIGHT CONTROL PROGRAM"
- ADD YEARS TO YOUR LIFE
- LOSE WEIGHT AND IMPROVE MUSCLE TONE
- EASE EVERYDAY TENSIONS AND STRESS
- LOWER BLOOD PRESSURE
- INCREASE ENERGY AND PHYSICAL ENDURANCE
- REDUCE RISK OF HEART DISEASE

FRED A. STUTMAN, M.D. WITH LILLIAN AFRICANO



Health Mart
Suntan Lotion
S P F 15 or 8
4 oz. \$2.99

Luv's
Delux
\$9.49

Charmin
99¢

Fish Oil
Capsules
\$4.99

Dish Cloths
Waffle Weave
29¢

Limit 4
20 Bic Razors
\$1.99

Don't let your profits get eaten up.

Protect your income with U.S. AG Multi-Peril Crop Insurance. It can happen in seconds, days, or months and there's nothing you can do about it. Hail, insect damage, drought or a dozen other unexpected disasters can wipe out a year's investment of time, money, and labor. Why risk it? U.S. AG Multi-Peril Crop Insurance lets you reduce the uncertainties of crop production from covered catastrophes. Let us show you how.

NORPP
Insurance Agency, Inc.
(806) 874-3521 Clarendon, Texas

USAG
Insurance Services, Inc.

Bivens
HEALTH MART
Pharmacy
PROFESSIONAL HEALTH CARE



We Accept:

PCS

Open Weekdays
9 a.m. to 6 p.m.
Saturday
9 a.m. to 5 p.m.
Pharmacy Open
Sat. 9 to 2 p.m.

HEALTH MART HEALTH SMART
Are you aware of the possible side effects of your prescription? Talk to your Health Mart pharmacist before you get your next prescription filled.

Hedley News

by Nina Riddlespurger

Jess Bridges celebrated his birthday on Friday, March 10th. Hope Jess had a great day. Happy Birthday, Jess!

Caroll Messer celebrated his birthday on Saturday, March the 11th. Happy Birthday Caroll!

Also celebrating birthdays on Tuesday, March 14th were Sharon Ferguson and Kelly Bridges. Hope both these gals had a great birthday.

On Thursday, March 16th Ellen Faye Land celebrated her birthday. Happy Birthday, Speck!

Pauline Heath from Clarendon visited with her sister-in-law, Opal Murry on Saturday. They had lunch at the Hedley Cafe.

Shorty Crawford spent last week in Amarillo. She was staying with her granddaughter while her daughter and son-in-law were in Phoenix, Arizona at a American Quarter Horse Convention. I also spent last week in Amarillo trying to learn to cook donuts. Shorty got up each morning at 2:30 am and went with me. After the initial shock wore off we really had a lot of fun. We will soon see how much we learned.

Nora Hartwell went to Amarillo on Sunday. Nora had an appoint-

ment to see the Doctor on Monday. V. T. McPherson and Phillip Wiggins attended the regular meeting of the Greenbelt Water Authority on Thursday, the 9th of March. The meeting was held at the Cowboy Corral in Childress.

Mary Pycatt from Amarillo and Jauvada Curtis of Garland visited with Pauline Kaufman and Shorty Crawford on Monday. These are aunts of Pauline and Shorty's. They had lunch at the Hedley Senior Citizens with Pauline and Shorty.

Jeffery Brinson had his 11th birthday on Thursday the 2nd of March. Because of the weather the celebration was postponed until Sunday the 11th of March. A cookout was held in his honor at his parents home in Memphis. Jeff is the son of Mr. and Mrs. Ricky Brinson. There were 35 people who attended the celebration. Those who attended from Hedley were: Dorothy and Kenneth Brinson, Bobby Frank Lindsey, Otis Farris, Keith Brinson, Mark, Tammy and Lindsey Brinson.

Margie Bailey is back home in Hedley after her accident in Amarillo. Margie came home on Thursday and is doing fine. We are all very glad to have her home.

Hedley Senior Citizens Activities

Monday March 20
Staff Meeting; 10:30 am Exercise; 9:00-3:00 pm Games; 9:00-3:00 pm Quilting; Noon Lunch 12:00; 6:30 pm Musical

Tuesday March 21
10:30 am Exercise; 9:00-3:00 pm Games; 9:00-3:00 pm Quilting; 12:00 Noon Lunch; 5:30 pm Games

Wednesday March 22
10:30 am Exercise; 9:00-3:00 pm Games; 9:00-3:00 pm Quilting; 12:00 Noon Lunch; 2:30 pm Grocery Trip

Thursday March 23
10:30 am Exercise; 9:00-3:00 pm Games; 9:00-3:00 pm Quilting; 12:00 Noon Lunch; Blood Pressure Clinic; 5:30 pm Games

Friday March 24
10:30 am Exercise; 9:00-3:00 pm Games; 9:00-3:00 pm Quilting; 12:00 Noon Lunch

Saturday March 25
Movies 7:00 pm

Hedley Senior Citizens Menu

Thursday March 16 Stew w/tomatoes, Carrots, Potatoes, etc., Jellied Fruit Salad, Corn Muffin, Peach Cobbler, Coffee, Tea, Milk, Juice

Friday March 17 Turkey w/dressing, Giblet Gravy, Cranberry Sauce, Broccoli, Carrot Sticks, Roll, Fruit Cup, Coffee, Tea, Milk, Juice

Monday March 20 Meatloaf, Creamy Macaroni, Okra, Green Vegetable Salad, Roll, Strawberry Short Cake, Coffee, Tea, Milk, Juice

Tuesday March 21 Oven Fried-Chicken, Mashed potatoes, Zucchini, Carrot'n Raisin Salad, Roll, Cherry Cobbler, Coffee, Tea, Milk, Juice

Wednesday March 22 Steak w/Gravy, Baked Potato, Topping as desired, Green Beans, Roll, Fresh Fruit Cup, Coffee, Tea, Milk, Juice

Hedley Senior Citizens News

by Nina Riddlespurger

We had a great Musical on Monday night. There were 34 people who attended and enjoyed all the good singing and playing. Those who provided the music were: Jack Davidson, Nova Neuhaus, Hugh Neuhaus, Creed Smith, Dee Williams, Jake Smith and Weldon Petty. These folks always do a great job for us in our musicals.

On Tuesday afternoon we had 6 who played dominos. There were 18 who played at our 84 Club on Tuesday evening.

Wednesday afternoon there were 9 playing dominos. We had 4 who went on our Grocery Shopping

Trip. There were 28 checked in our Blood Pressure Clinic on Thursday afternoon. We also had 7 who played dominos on Thursday afternoon. Thursday evening we had 16 who attended our 84 Club.

Hedley CISD Open House

Hedley CISD held its annual Open House on Thursday, March 9, 1985. The theme of the Open House was "25 Years of Education in Hedley." This theme was used in conjunction with the final bond payment on the school building. Approximately 300 people attended the ceremony which was begun in the Hedley gymnasium.

Mr. Holland presented the welcome and provided some trivia information comparing 1966 and 1985. Some of the comparisons are as follows:

Budget	1966--\$168,000	1985--\$550,000
Teachers Starting Salary	4,000/year	15,200/year
Employees	22	16
Cooks	900.00-990.00/year	16
Salaries	4.00-4.15/Hr.	14
District Value	4,000,000	18,000,000
doubled in size with	Quail	22,000.00
School Bus Cost	185	100
Students	185	100
Tax Rate	.70/100.00 value	1.30/100.00 value
(taxed at 50% of value)	November Gas Bill	24.99
November Elect. Bill	236.71	1,066.62
Seniors	3	14

Mr Holland reported that 225 students had graduated from Hedley High School from 1965-1985. The current employees of Hedley School were introduced, along with the number of years of employment at Hedley School.

They are: Glyndol Holland-Spt.-19 years, Bryan Hill-Principal and Coach-7 years, Janny Longan-K-1-4 years, Nancy Woodard-2 thru 3-8 years, Linda Naylor-4 thru 5-1 year, Sheila Wade-6th grade-9 years, Terry Collins-Health and PE-6 years, Becky Hill-Ch.1 and Reading-13 years, Andera King-English and Spanish-1 year, La Moss Lambert-Science and PE-5 years, Jon Leggitt-Math and Computer-13 years, Lyndon Messer-Social Studies-5 years, Cheryl Pickard-Home Eco. and Business-5 years, Hoss Pickard-Vo. Ag-5 years, Sharon Wheatley-Special Education and Counselor-14 years, Nancy Mullins-Bookkeeper and Library Side-11 years, Kay Tally-Teachers Aide-3 years, Jessie Aleton-Cook and Bus Driver-3 years, Brenda Walker-Cook-1 year, Jose Andaverdi-Custodian and Bus Driver-1 year, Sue Brown-Nurse-1 year, Sylvia Lewis-Librarian-1 year.

The introduction of special guests then proceeded. Former employees or their representatives were recognized. Kenneth Sams,

Jack Webster, Flossie Wood, Peggy Maxcey, Dean Nivens, and Leone Taylor were unable to attend. However, ten former employees or their representatives were present. The following people were recognized:

Duane Reynolds is now teaching math for Silverton ISD. Doyle Messer retired in 1984 from Hedley School with 34 years in public education.

Evelyn Messer retired in 1985 from Hedley School with 38 years in public education. Connie Debord retired in 1984 from Hedley School with 28 years in public education. Sue Shields retired in 1978 with 20 years in public education. Joyce Boliver retired in 1984 with 28 years in public education. Ida Lon Dickson was represented by Jewell Quisinberry. Ida Lon retired from Panhandle ISD in 1987 after 26 years in public education.

J. M. Baker was represented by his daughter, Kathryn Jones of Memphis. J. M. had lived for the past ten years in Perryton where he died on December 26, 1988. J. M. retired in 1966 from Hedley School with 50 years in public education. He taught his wife and all six of his children. Mr. Holland reported that in 1966, with 49 years of experience, J. M.'s salary was \$5,508.00 per year.

Dot Messer worked as a cook through the 1967 school year. C. O. Stephens was represented by his wife, Callie Stephens of Hedley. Clarence was custodian during the 1965-66 school year. He had retired in Hedley before his death in 1986.

The 1965-66 school board had six members or their representatives present. The board was praised for its courage, foresight, work, and commitment to education. The following were introduced: Buford Holland-1966 Board President and board member from 1961-1970. Earl Wheatley-1966 Board Vice-President and board member from 1961-1970. James Evans-board member from 1960-1966. Harold White-Board member from 1956-1981. Harold had served for 25 years on the Hedley Board of Trustees. Don Springer served two different terms for 1965-1969 and from 1975-1980. E. L. Floyd was represented by his daughter, Janice Alexander of Memphis. Ed served from 1958-1970. Ed died in February of 1986. W. L. Stewart who was 1966 board secretary was unable to attend because of weather conditions in Saint Jo, his current home town. Dub served from 1960-1968 on the Board of Trustees.

Everyone then enjoyed a tour of the school facilities. Student work samples were displayed and several bulletin boards and timelines provided a trip back into past years at Hedley School. Hedley School yearbooks and personal picture al-

bums were available for viewing. People present visited and reminisced about Hedley School.

Refreshments were provided by the Future Homemakers of America, sponsored by Cheryl Pickard. Geneva McAfee, a 1975 Hedley High School graduate and co-owner of The Cakery in Amarillo, provided a huge cake depicting the newly constructed 1966 school building.

Open House at Hedley School was certainly a momentous occasion. It took a great deal of work by the faculty and employees. Much research and extra effort took place to review the past twenty-five years. According to several comments, the effort was well worth it.

Hedley Lioness Club

The Hedley Lioness Club met Thursday night, March 2nd and discussed plans for an Open House to be held on March 12th from 2:00 pm to 3:00 pm. All our friends are invited to see our newly remodeled building.

Members present were; Evelyn Messer, Juanell Carson, Louise Stewart, Helen Lamberson, Dorothy Whitaker, Mahdean Debord, Sue Weatherly, Nora Hopper, Betty Morgan, Mary Ruth White, Pauline Kaufman, Nancy Woodard, Sharon Ferguson, Grace Gardenhire and a special guest, Judy Bland.

Hedley School Menu

Monday March 20 Hot Steak Sandwich w/Gravy and Toast, Carrot Sticks, Hash Browns Potatoes, Cinnamon Rolls, 1/2 pint Milk

Tuesday March 21 Oven Fried Chicken, Hominy Casserole, Corn on the Cob, Jello, Hot Rolls w/Butter, 1/2 pint Milk

Wednesday March 22 Chalupas, Salad, Spanish Rice, Chocolate Cake, 1/2 pint Milk

Thursday March 23 Turkey Roast w/Gravy, Mashed Potatoes, Green Beans, Honey and Butter, Hot Rolls, 1/2 pint Milk

Friday March 24 Cheese Burgers, French Fries, Lettuce, Tomatoes, Pickles, Onions, Cookies, 1/2 pint Milk

Shop Clarendon First!

Millions of People Don't Have Group Insurance

Are You One of Them?

Self-employed or work for a small business?

\$1,000,000 Individual Major Medical.

Choice of deductible: \$250, \$500, \$1,000

ASK FOR A QUOTE

For costs, benefits, exclusions, limitations and renewal terms contact:

JEM Simmons
874-3506

Emmett O. Simmons Insurance
Golden Rule "A" Rated (Excellent)
Choice of deductibles varies in some states.

This Sunday, March 19th Is

"Christian Family Sunday"

At The Calvary Baptist Church

- Services are at 10:00 and 11:00 a.m. and 7:00 p.m.
- Evangelist Monty Martin Will Be Our Special Guest Speaker
- Bro. Martin Will Be Singing And Preaching In The A.M. and P.M. Services
- There Will Be A Special Mini-Concert During The Sunday School Hour
- We Want To Invite You To Come And Bring Your Family For This Special Day
- A Nursery Will Be Provided For Each Service

"The Church Where The Folks Take Time To Be Friendly"

Mike's Pharmacy
874-3554

Appetite Suppression Product Ingredients

While some health authorities believe nonprescription appetite suppressant products are of no proven long-term value in controlling obesity, others feel that these products may provide valuable assistance to overweight persons. Popular appetite suppressants include:

Phenylpropanolamine: The U.S. Food and Drug Administration has determined that this ingredient is probably safe and effective as a nonprescription appetite suppressant. Phenylpropanolamine is thought to cause a reduction in appetite through its stimulant, adrenalin-like action. An individual with hypertension, thyroid disease, diabetes, or heart disease should consult a physician before using products containing phenylpropanolamine.

Benzocaine: This ingredient is a local anesthetic that can numb the mucous membranes. Appetite suppression products containing benzocaine may be chewed (candy and gums) or swallowed (tablets and capsules).

Methylcellulose: Bulk-producing agents such as methylcellulose and other dietary fibers may delay or prevent the absorption of ingested calories. These ingredients also may produce a sense of being "full."

Senior Citizens Receive 15% Discount On Prescriptions

Welcome PCS Member Pharmaceutical Card System, Inc.

Mail Orders receive Prompt Service

Across From B & R THRIFTWAY

MIKE WANTS TO BE YOUR PHARMACIST

100% MEDICARE SUPPLEMENT POLICY

Pays 100% of your hospital deductible. Pays 100% of doctor's office calls, hospital calls, outpatient expenses, X-rays, lab work not paid by Medicare. Also available is Home Health Care, Long Term Nursing Home Care, \$10,000.00 Life Insurance with no physical.

For more information, please return the information request form listed below.

MEDICARE SUPPLEMENT INSURANCE
P.O. Box 50900
Amarillo, Texas 79159-0900

Name _____ Age _____
Address _____ Phone _____
City _____ State _____ Zip _____

THE NOOK

Brentwood By Brenner Ladies

30% OFF

Men's Knit Shirts by Munsingwear

30% OFF

CLASSIFIED

VFW POST 7782 will meet at 7:00 p.m., 1st and 3rd Thursdays at the Community Center. 41 tfc

CLARENDON LODGE #700AF/AM Stated Meeting: 2nd Monday each month 7:30 p.m.
Practice Sessions: 4th Monday
John Sarich WM
Willard Skelton Secretary
Refreshments served at 6:30 p.m.

CASH BUSINESS...
Buy this high profit candy vending route. Nationally proven program since 1959. Nice family business - includes training. Requires cash investment of \$4237 to \$14070. Call 1-800-328-0723

EAGLE INDUSTRIES
Since 1959

ATTENTION - HIRING!
Government jobs - your area. \$17,840 - \$69,485. Call 1-602-838-8885. EXT R 444
9-4tp

Easy Work! Excellent Pay!
Assemble products at home. Call for information. 504-641-8003 Ext. 8779
9-2tp

Garage Sale:

Garage Sale: 210 E. Rosenfield. Lots of Misc. Friday and Saturday the 17th and 18th. 11-1tp

Garage Sale Saturday 18th 9:00 - ? Corner of 8th and McLean - toys - household items, shotgun, mens, womens, childrens clothes, tables. Lots of other items. 11-1tp

Spring Cleaning Sale: 3 - Wheeler, lots of misc items. Raising money for state twirling pageant Dunn's 3 miles West on 287. Saturday only 10 a.m. 11-1tc

Garage Sale: Friday and Saturday from 9 a.m. to 4 p.m. Corner of Ayers and Rosenfield. Second house on right behind Chamberlain's. Tools and household goods. 11-1tp

Garage Sale: Friday the 17th, Saturday 18th, 9 a.m. to 5 p.m. 25 Palacio Howardwick. Freezer, Bar B Q, Aircleaner and many Misc. items. 11-1tp

ADDITIONAL EXEMPTIONS MAY LOWER YOUR TAXES!

If you became 65 or disabled during 1988, you may qualify for additional property tax exemptions on your homestead. If you bought a different home during 1988 you may need to file a new homestead exemption application. Applications should be filed by May 1.

If you received a homestead exemption on your present home in 1988, you will not need to reapply for 1989.

Further details about the property tax system in Texas and how it works for you are contained in a pamphlet by the State Property Tax Board called Taxpayers' Rights, Remedies, Responsibilities. Get a free copy at the Appraisal District Office.

A \$1.00 charge will be added if statements are sent on classified ads. If you want your classified ad blocked, there will be an additional \$1.00 charge on the first ad.

Classified ad rates are \$3.50 for 15 words or less, 10 cents per word over 15 words. Cards of thanks, average length is \$4.00. Subscription rate in Donley County is \$13.00 a year. Subscriptions for outside of Donley County and out of state are \$16.00 a year. Six month subscriptions are \$8.00 and three month subscriptions are \$6.00. Display ads on request.

LAMPS LAMPS LAMPS
all light bulbs
HOUSE OF SHADES
and
LAMP REPAIR
Wolfin Village
Wolfin Avenue
Amarillo, Texas 79109

FREE COLOR ANALYSIS:
Beauty-Control Cosmetics introducing SKINLOGICS and MICRODERM state of the art products. Call DARLENE SPIER 874-3527 10-4tc

NEEDED: The First Baptist Church of Hedley is looking for a building to use for a clothing ministry. If you know of some building, please call 856-5370 or 856-5989 11-3tc

GRASS SEED
Call us today for reduced prices on most of our grasses for your CRP needs. Free delivery on all orders. Call **GRASS SEED SERVICES 806-385-5229 DAY OR NIGHT 11-4tc**

Notice of City Officers' Election

City of Howardwick, Texas

Notice is hereby given that a City Officers' Election will be held on the 6th day of May 1989 in Howardwick, Texas for the purpose of election of a mayor and 2 alderman. Said election will be held at the Howardwick City Hall. The polls shall on said election day be open from 7:00 o'clock a.m. to 7:00 o'clock p.m.

The form for application to place name on ballot is available at City Hall in Howardwick, Texas. The application must be completed and returned to the City Secretary at Howardwick City Hall prior to 5:00 p.m. on March 22, 1989. Drawing for position of names on ballot will be conducted on at 10:00 a.m. at Howardwick City Hall.

The absentee voting for the above designated election shall be held at Howardwick City Office and said place of absentee voting shall remain open on each day of absentee voting which is not a Saturday, Sunday or an official state holiday, beginning on the 20th day before Election Day and continuing through the 4th day preceding the date of said election. Said place of absentee voting shall remain open between the hours of 9:00 a.m. to 12:00 noon and from 1:00 p.m. to 4:00 p.m.

Trash Holes - Cesspools from \$250.00. Big Hole Drilling 806-383-2424
1-13tp

For Sale

For Sale: 644 Acres South of Hedley, Must Sell, 380 Acres Cultivated, 2 Houses, Other Improvements Call 259-2651 or 259-3261 11-3tc

For Sale or Rent: 4 Bedroom Brick House Call 874-2005 11-4tc

For Sale: Rockwood Travel Trailer 874-3272 10-2tp

For Sale: 1985 Dodge Royal SE Ram 150 - Good Pickup Call 856-5964 10-3tp

For Sale: 1979 Ford 4X4 - 300 Engine - 4 Speed - New Tires - Brakes Call 856-5964 10-3tp

For Sale: By Owner. 3 bedroom, 2 Bath Brick, 2 living areas, Fireplace, double Garage, Patio, fenced yard. 1614 W. 7th. See by appt. 806-874-2255 3-tfc

Wanted to Buy: Wrecked or junked car bodies, obsolete farm equipment and scrap metal of all kinds. Call 867-3111. 9-4tp

House For Sale: 2 Br, Bath, Laundry Room, Washer/dryer hookups. 609 Burkhead Call 874-2296 or (806)372-9205 9-tfc

(Beefmaster Bulls) For Sale: Age 20 -24 mos. Inquire Stafford Farm Store Roaring Springs. Day 348-7271 Nights 347-2804 9-4tc

For Rent or For Sale: 4 1/2 Blk from School. 2 Bedroom, 1 Bath, Den and Living Rm, Washer and Dryer hookup Call 874-3896 between 7:00 p.m. and 8:00 p.m. 11-2tp

For Sale: Small 2 bedroom 1 bath home at 717 W. 3rc. Would make excellent rental property. Call 874-3264 or 874-3880, ask for Dorothy.

Owner will finance with good down payment.

Ronnie Walker
Attorney At Law
Now Board Certified In Business Bankruptcy Law
Texas Board of Legal Specialization
504 S. Polk 372 3477

BOB MAJOR REAL ESTATE
RESIDENTIAL FARM RANCH
709 BOND ST. BOX 357
CLARENDON, TEXAS 79226 (806) 874-2230

Glidden Paints  
J & W Lumber
Glass & Screens
Storm Doors \$14.99
Storm Windows 874-2000

CLARENDON MOTOR CO.
Darell Harper Office: 874 5066
E. Highway 287 Res: 874 3687
Pre Owned Autos at a Reasonable Price
Come In and Make us an Offer
WE will buy your car or sell it for you on Consignment
Windshields Professionally Installed by Appointment
We Can save your deductible in most cases.

TERMITE PROBLEMS
Call for best termite control Over 20 years experience Call collect 383-7075
3608 N.E. 23rd
Amarillo, Texas 79107
State Lic. No. 1178
LEO RUSSELL 

MOVERS
Mobil Homes, Boats, R. V.'s etc.
Licensed, Insurance, Bonded
48 States
WE'RE THE COMPETITION
John W. Mays
806-874-2711 or 806-359-0788

Chamberlain MOTOR COMPANY
HIGHWAY 287 CLARENDON, TEXAS
BUICK*OLDSMOBILE
PONTIAC*CADILLAC*GMC TRUCKS
FRED CLIFFORD Home Phone (806) 874-2415
Clarendon (806) 874-3527
Amarillo 376-9041
Texas WATS (800) 692-4088

Postive Feed Inc.
28% Protein
Ron Munson
(After 7 p.m.) 874-3116

CLARENDON T-SHIRTS Sponsored by the Clarendon-Donley Co. Chamber of Commerce 874-2421
Price \$10.00
 White
 Turquoise
 Black
Mail to:
Name _____
Street _____
City _____
Discounts available for teams or organizations
1) 10% off for individual purchase of 10 or more
2) 10% off for teams or organizations

Amarillo Livestock Auction
Sale Every Tuesday
This Week's Receipts: 9,300
Feeder Steers Over 500-Steady to weak; Under 500-\$1 to \$2 lower. Feeder Heifers Over 500-Steady to \$1lower; Under 500-\$1 to \$2 lower.
Feeder Steers:
300-400#- 105.00-114.00
400-500#- 92.00-99.00
500-600#- 82.50-90.00
600-700#- 79.00-82.50
700-800#- 77.50-80.10
Feeder heifers:
300-400#- 95.00-99.50
400-500#- 83.25-90.00
500-600#- 78.25-82.50
600-700#- 75.80-78.35
Slaughter cows: 46.00-51.50
Slaughter bulls: 60.00-64.00
Field Representative-
Ron Munson 874-3116

FOR SALE: new and used aero motor windmills and parts. Submersible pump, stock tanks, water well drilling and service, custom hay hauling. John Morrow 874-2704. 51-tfc

For Sale: Cafe on Highway 287 E. with 3 Bedroom Home included. Will take travel trailer or Motor Home in Trade 874-3234 11-1tp

For Rent: 2 bedroom Duplexes. Furnished or unfurnished. Central heat and air. Newly remodeled. Also efficiency apartments, furnished or unfurnished. Call 874-2374 11-2tc

For Sale: Large Desk and Chair 874-2252 11-2tc

For Sale: Good used washer and dryer. Phone 874-3517 ask for Dorisene 11-1tp

For Sale: Houses 4 and 6 acre plots w/houses and Ford's Cafe 287 E. Call before 3 or after 7 p.m. Sanders Real Estate 874-2533 10-3tc

TRALEE
CRISIS CENTER
FAMILY VIOLENCE & RAPE
TOLL FREE
1-800-828-2891
SHELTER & TRANSPORT

Donley County
Registered Suffolks
For Sale: Ewes, Rams, Lambs
Call: Denny Askew 874-5001
A.C. Saye 874-3844
Clarendon Tx 79226

SANDERS REAL ESTATE
Oneta Sanders Broker

806-874-2533
Specializing in Residential Properties Listings Wanted
Over 25 Years Experience
700 S. McClelland • Clarendon, Texas

Remodeling and Repair
Room additions, custom trim, custom furniture, cabinet making and ceramic tile work. Commercial and Residential Dearen and Coronis Builders
307 W. Foster
Pampa, Texas 669-1211

OWENS BOOT SHOP

RED WING SHOES

Neeley
Income Tax and Bookkeeping
Small Businesses and Farms Individual Returns We also do W-2's
806-447-5893 NEW CUSTOMERS WELCOME 1099's, 941's and 943's
Onall, Texas

ALLEN ESTLACK
Electrical and Appliance Repair
Call 874-3683 Box 596
Bonded & Licensed

Brown-McMurtry Implement
PHONE 806-823-2441
BOX 777
SILVERTON, TEXAS 79257 SALES & SERVICE
DON BROWN Home Ph. 823-2292
CLARENCE WARD Home Ph. 823-2083

Bailey Estes & Son
Welding Fabricating & Steel Buildings
-also self storage units for
RENT \$25.00 month

Make sure you get the tax refund you want!

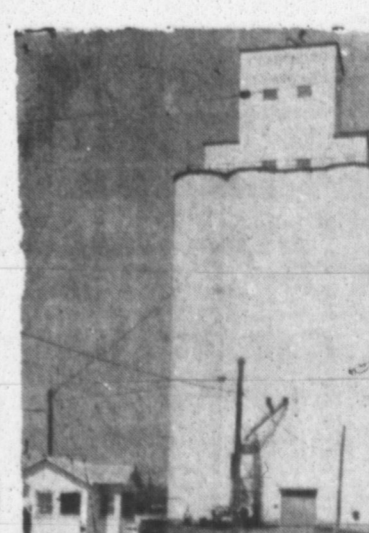
Introducing H&R Block's Planned Refund Program
For a small fee, our experienced preparers will analyze your taxes to plan your next year's refund at the amount you decide. Get the refund you want using the Planned Refund Program. H&R Block's new W-4 service.
H&R BLOCK IF THERE'S EVER A TIME FOR H&R BLOCK, IT'S NOW.
Joleen Lockeby 316 E. White, Clarendon 806-874-3690

BUYERS AND SELLERS
All
Kinds of Grain
70 Ft. Scales
Clarendon Grain Elevators, Inc.

J. R. GILL
P.O. Box 805
Clarendon, Tex. 79226
874-3172

St. Patrick's Day Sale!

Boneless Corn King

Hams 1/2 or Whole **\$1.69** Lb.



U. S. Choice Top Boneless

Sirloin Steak

2.79 Lb.



Wilson All Meat

Franks 12 Oz. Pkg. **79¢**



Nice & Lean Boneless

Cubed Steak **\$2.59** Lb.

Wrights Sliced Slab

Bacon **\$1.09** Lb.



Extra Lean Fresh

Ground Chuck **\$1.59** Lb.

Shurfine Chunk Light

Tuna 6 1/2 Oz. Can **59¢**

Blackburns Crystal White

Syrup Quart Decantor **\$1.19**

Shurfine Golden Cream Style or Whole Kernel

Sweet Corn **2.89¢** #303 Cans

Shurfine All Purpose

Flour 5 Lb. Bag **89¢**



Shurfine Cut

Green Beans **2.89¢** #303 Cans

Shurfine

Sugar 5 Lb. Bag **\$1.79**

Kelloggs

Frosted Flakes 20 Oz. Pkg. **\$2.69**

Hunts Tomato

Ketchup Quart Bottle **\$1.19**

Betty Crocker Layer

Cake Mixes Ass't Flavors **99¢**

Cat Cafe

Cat Food 10 Lb. Bag **\$3.49**

Mountain Grown Bulk

Pinto Beans **49¢** Lb.

Lipton

Tea Bags 100 Cnt. Pkg. **\$2.69**

Shursaver

Tomato Sauce 8 Oz. Cans **\$1.00**

Jeno's Frozen

Pizza 7 Oz. **99¢**



Shurfine **Coffee**

\$1.89



1 Lb. Can

Top Job

Liquid Cleaner All Purpose

\$1.79

28 Oz. Bottle

U. S. #1 Colorado White Russett

Potatoes

\$1.79

10 Lb. Bag



Hunts

Tomato Juice 46 Oz. Can **99¢**

Lucky Leaf

Apple Juice 48 Oz. Bottle **\$1.19**



Brazilian Boneless

Catfish Fillets **\$2.89** Lb.

Keekler Soft Batch Ass't

Cookies 12 Oz. Pkg. **\$1.39**



Campbells

Pork & Beans 2 #300 Cans **89¢**

Lays

Potato Chips Reg. \$1.59 Value **\$1.19** 7 1/2 Oz. Bag



Kraft Jet Puff & Miniature

Marshmallows

89¢

1 Lb. Bag



Bold

Laundry Detergent

\$1.99

Giant 42 Oz. Box

Angel Soft

Bathroom Tissue

99¢

4 Roll Pkg.

Spic & Span

Cleanser

79¢

8 Oz. Box

Kleenex

Facial Tissues

89¢

175 Cnt. Pkg

Shursaving **Paper Towels**

2.99¢

Ad Good March 15-18, 1989

THE GROCERY STORE

Open Mon.-Sat. 7 a.m. - 7 p.m. Closed Sunday

Home Owned and Operated by Jack and Shirley Clifford

874-2425 Clarendon

DOUBLE COUPONS EVERYDAY

Excluding Cigarette and Tobacco Coupons
Excluding Free Coupons

Double Coupons not to exceed item value
Double Coupons not to exceed \$1.00

Only One Double Coupon honored on multiple purchase of an item